

DrayTek

VigorIPPBX 2820 Series

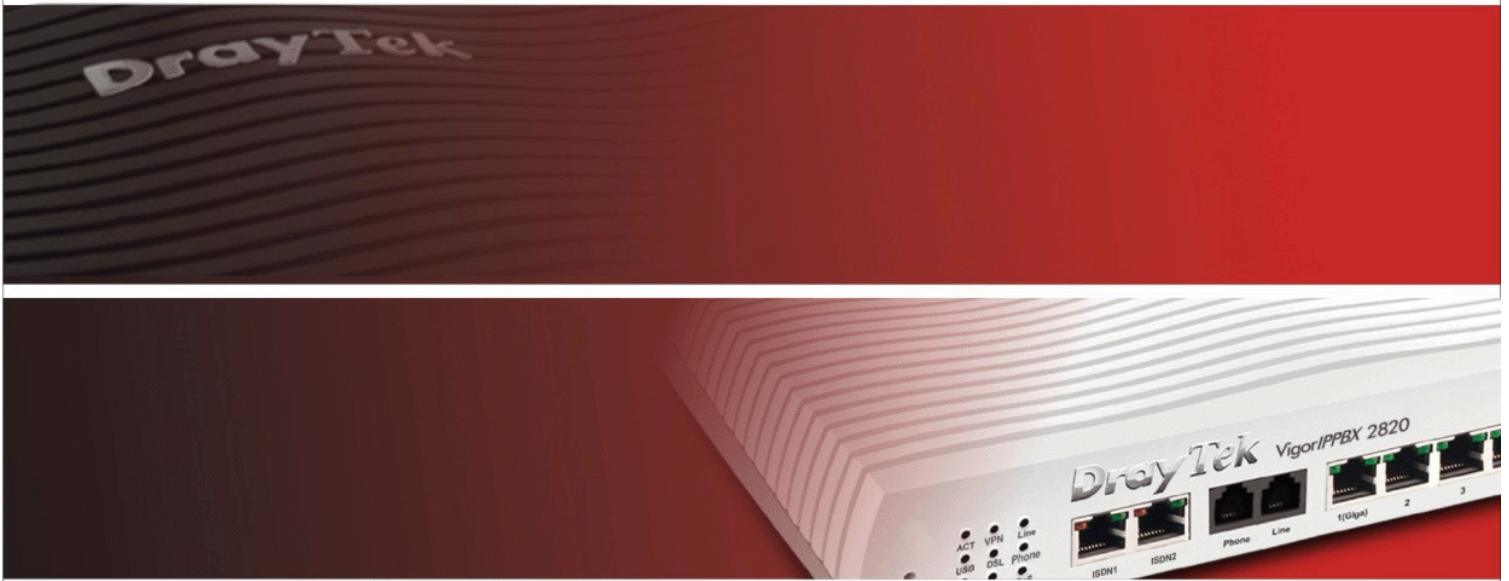

Your reliable networking solutions partner

User's Guide

V2.3

Vigor*IPPBX* 2820 Series User's Guide

Version: 2.3

Based on Firmware Version: V3.5.5_RC3

Date: 25/08/2010

Copyright Information

Copyright Declarations

Copyright 2010 All rights reserved. This publication contains information that is protected by copyright. No part may be reproduced, transmitted, transcribed, stored in a retrieval system, or translated into any language without written permission from the copyright holders.

Trademarks

The following trademarks are used in this document:

- Microsoft is a registered trademark of Microsoft Corp.
- Windows, Windows 95, 98, Me, NT, 2000, XP, Vista and Explorer are trademarks of Microsoft Corp.
- Apple and Mac OS are registered trademarks of Apple Inc.
- Other products may be trademarks or registered trademarks of their respective manufacturers.

Safety Instructions and Approval

Safety Instructions

- Read the installation guide thoroughly before you set up the router.
- The router is a complicated electronic unit that may be repaired only by authorized and qualified personnel. Do not try to open or repair the router yourself.
- Do not place the router in a damp or humid place, e.g. a bathroom.
- The router should be used in a sheltered area, within a temperature range of +5 to +40 Celsius.
- Do not expose the router to direct sunlight or other heat sources. The housing and electronic components may be damaged by direct sunlight or heat sources.
- Do not deploy the cable for LAN connection outdoor to prevent electronic shock hazards.
- Keep the package out of reach of children.
- When you want to dispose of the router, please follow local regulations on conservation of the environment.

Warranty

We warrant to the original end user (purchaser) that the router will be free from any defects in workmanship or materials for a period of two (2) years from the date of purchase from the dealer. Please keep your purchase receipt in a safe place as it serves as proof of date of purchase. During the warranty period, and upon proof of purchase, should the product have indications of failure due to faulty workmanship and/or materials, we will, at our discretion, repair or replace the defective products or components, without charge for either parts or labor, to whatever extent we deem necessary to restore the product to proper operating condition. Any replacement will consist of a new or re-manufactured functionally equivalent product of equal value, and will be offered solely at our discretion. This warranty will not apply if the product is modified, misused, tampered with, damaged by an act of God, or subjected to abnormal working conditions. The warranty does not cover the bundled or licensed software of other vendors. Defects which do not significantly affect the usability of the product will not be covered by the warranty. We reserve the right to revise the manual and online documentation and to make changes from time to time in the contents hereof without obligation to notify any person of such revision or changes.

Be a Registered Owner

Web registration is preferred. You can register your Vigor router via <http://www.draytek.com>.

Firmware & Tools Updates

Due to the continuous evolution of DrayTek technology, all routers will be regularly upgraded. Please consult the DrayTek web site for more information on newest firmware, tools and documents.

<http://www.draytek.com>

European Community Declarations

Manufacturer: DrayTek Corp.

Address: No. 26, Fu Shing Road, HuKou Township, HsinChu Industrial Park, Hsin-Chu County, Taiwan 303

Product: VigorIPPBX 2820

DrayTek Corp. declares that VigorIPPBX 2820 of routers are in compliance with the following essential requirements and other relevant provisions of R&TTE Directive 1999/5/EEC.

The product conforms to the requirements of Electro-Magnetic Compatibility (EMC) Directive 2004/108/EC by complying with the requirements set forth in EN55022/Class B and EN55024/Class B.

The product conforms to the requirements of Low Voltage (LVD) Directive 2006/95/EC by complying with the requirements set forth in EN60950-1.

Regulatory Information

Federal Communication Commission Interference Statement

This equipment has been tested and found to comply with the limits for a Class B digital device, pursuant to Part 15 of the FCC Rules. These limits are designed to provide reasonable protection against harmful interference in a residential installation. This equipment generates, uses and can radiate radio frequency energy and, if not installed and used in accordance with the instructions, may cause harmful interference to radio communications. However, there is no guarantee that interference will not occur in a particular installation. If this equipment does cause harmful interference to radio or television reception, which can be determined by turning the equipment off and on, the user is encouraged to try to correct the interference by one of the following measures:

- Reorient or relocate the receiving antenna.
- Increase the separation between the equipment and receiver.
- Connect the equipment into an outlet on a circuit different from that to which the receiver is connected.
- Consult the dealer or an experienced radio/TV technician for help.

This device complies with Part 15 of the FCC Rules. Operation is subject to the following two conditions:

- (1) This device may not cause harmful interference, and
- (2) This device may accept any interference received, including interference that may cause undesired operation.

Please visit <http://www.draytek.com/user/AboutRegulatory.php>.



This product is designed for DSL, ISDN, and POTS network throughout the EC region and Switzerland with restrictions in France. Please see the user manual for the applicable networks on your product.

Table of Contents

Chapter 1: Preface	1
1.1 Web Configuration Buttons Explanation	1
1.2 LED Indicators and Connectors	2
1.2.1 For VigorIPPBX 2820	3
1.2.2 For VigorIPPBX 2820n	5
1.3 Hardware Installation	7
1.4 ISDN Phone Adapter Installation	8
1.5 Printer Installation	9
Chapter 2: Configuring Basic Settings	15
2.1 Changing Password	15
2.2 Quick Start Wizard	17
2.2.1 PPPoE/PPPoA	18
2.2.2 1483 Bridged IP	20
2.2.3 1483 Routed IP	21
2.3 IPPBX Wizard	22
2.3.1 Extension & Group Setup	22
2.3.2 SIP Trunk Setup	24
2.3.3 Office Hours Setup	25
2.4 Service Activation Wizard	27
2.5 Online Status	30
2.6 Saving Configuration	33
Chapter 3: Applications	35
3.1 The Registration of 50 IP-based Telephone/Extensions	35
3.2 The IP Registration from Remote Site (through WAN Connection)	36
3.3 The Integration IP Registration with SIP Server	37
3.4 The Integration VoIP Communications via SIP Server	38
3.5 The Integration with PSTN telephony	39
3.6 The Added ISDN Telephony	40
3.7 The Integrated ISDN line	41
3.8 The 4 B Channels of Two ISDN Lines	42
3.9 The Integration of ISDN PBX with One ISDN Line	43
3.10 The Integration of ISDN PBX with One ISDN Line-2	44
3.11 The Deployment of ISDN PBX and PSTN Network	45
3.12 The Integration of ISDN Telephony and PSTN Network	46
3.13 The Integration of ISDN Telephony, PSTN Network and VoIP Connection	47
Chapter 4: Tutorial	49

4.1 Create a LAN-to-LAN Connection Between Remote Office and Headquarter	49
4.2 Create a Remote Dial-in User Connection Between the Teleworker and Headquarter.....	57
4.3 QoS Setting Example.....	61
4.4 LAN – Created by Using NAT	65
4.5 Upgrade Firmware for Your Router	67
4.6 Request a certificate from a CA server on Windows CA Server.....	70
4.7 Request a CA Certificate and Set as Trusted on Windows CA Server	74
4.8 How to achieve DID (Direct Inward Dialing) with SIP Alias?.....	76
4.9 How to use Call Parking?.....	80
4.10 How to set up VigorPhone 350 with Vigor/IPPBX2820 series by using Auto-Provisioning? 82	
4.11 How to configure Hunt Group?.....	87
4.12 How to use Auto Attendant?.....	91
4.13 How to use Voice Mail?.....	97
4.14 How to configure and use the MWI on Vigor/IPPBX 2820?.....	103
4.15 How to register extensions to Vigor/IPPBX 2820?	106
4.16 How to configure and use ISDN-S0 MSN on Vigor/IPPBX 2820.....	111
4.17 Creating an Account for MyVigor	114
4.17.1 Creating an Account via Vigor Router	114
4.17.2 Creating an Account via MyVigor Web Site.....	117
4.18 How to use mOTP feature through the router and iPhone	120

Chapter 5: Reference - Advanced Web Configuration..... 125

5.1 WAN	125
5.1.1 Basics of Internet Protocol (IP) Network.....	125
5.1.2 Network Connection by 3G USB Modem	126
5.1.3 General Setup.....	126
5.1.4 Internet Access	129
5.1.5 Multi-PVCs.....	145
5.1.6 Load-Balance Policy	150
5.2 LAN	152
5.2.1 Basics of LAN	152
5.2.2 General Setup.....	154
5.2.3 Static Route	157
5.2.4 VLAN.....	160
5.2.5 Bind IP to MAC	162
5.3 NAT	163
5.3.1 Port Redirection	164
5.3.2 DMZ Host.....	166
5.3.3 Open Ports.....	168
5.3.4 Address Mapping.....	170
5.3.5 Port Trigger	171
5.4 Firewall.....	173
5.4.1 Basics for Firewall.....	173
5.4.2 General Setup.....	175
5.4.3 Filter Setup	177
5.4.4 DoS Defense	184

5.5 Objects Settings	187
5.5.1 IP Object	187
5.5.2 IP Group	189
5.5.3 Service Type Object	190
5.5.4 Service Type Group	191
5.5.5 Keyword Object	192
5.5.6 Keyword Group	193
5.5.7 File Extension Object	194
5.6 CSM	196
5.6.1 APP Enforcement Profile	197
5.6.2 URL Content Filter Profile	200
5.6.3 Web Content Filter Profile	204
5.7 Bandwidth Management	208
5.7.1 Sessions Limit	208
5.7.2 Bandwidth Limit	209
5.7.3 Quality of Service	210
5.8 Applications	218
5.8.1 Dynamic DNS	218
5.8.2 Schedule	220
5.8.3 RADIUS	222
5.8.4 UPnP	223
5.8.5 IGMP	225
5.8.6 Wake on LAN	226
5.9 VPN and Remote Access	227
5.9.1 Remote Access Control	227
5.9.2 PPP General Setup	228
5.9.3 IPSec General Setup	229
5.9.4 IPSec Peer Identity	230
5.9.5 Remote Dial-in User	232
5.9.6 LAN to LAN	236
5.9.7 Connection Management	245
5.10 Certificate Management	246
5.10.1 Local Certificate	246
5.10.2 Trusted CA Certificate	248
5.10.3 Certificate Backup	249
5.11 ISDN	249
5.11.1 Basic Concept	249
5.11.2 General Setup	250
5.11.3 Dial to Single ISP	253
5.11.4 Dial to Dual ISPs	254
5.11.5 Call Control	256
5.12 IP PBX	257
5.12.1 Extension	258
5.12.2 Line Setting	263
5.12.3 Dial Plan	269
5.12.4 PBX System	274
5.12.5 PBX Status	305
5.13 Wireless LAN	306
5.13.1 Basic Concepts	306
5.13.2 General Setup	308
5.13.3 Security	311

5.13.4 Access Control.....	313
5.13.5 WPS.....	314
5.13.6 WDS.....	316
5.13.7 Advanced Setting.....	319
5.13.8 AP Discovery	320
5.13.9 Station List	321
5.14 USB Application	322
5.14.1 USB General Settings.....	322
5.14.2 USB User Management.....	323
5.14.3 File Explorer.....	325
5.14.4 Disk Status.....	326
5.15 System Maintenance.....	327
5.15.1 System Status.....	327
5.15.2 TR-069	329
5.15.3 Administrator Password.....	330
5.15.4 Configuration Backup	330
5.15.5 Syslog/Mail Alert	332
5.15.6 Time and Date	334
5.15.7 Management.....	335
5.15.8 Reboot System	336
5.15.9 Firmware Upgrade	337
5.16 Diagnostics.....	339
5.16.1 Dial-out Trigger	339
5.16.2 Routing Table	340
5.16.3 ARP Cache Table	340
5.16.4 DHCP Table.....	341
5.16.5 NAT Sessions Table	341
5.16.6 Ping Diagnosis.....	342
5.16.7 Data Flow Monitor.....	343
5.16.8 Traffic Graph.....	344
5.16.9 Trace Route	345

Chapter 6: Trouble Shooting.....347

6.1 Checking If the Hardware Status Is OK or Not.....	347
6.2 Checking If the Network Connection Settings on Your Computer Is OK or Not	348
6.3 Pinging the Router from Your Computer	350
6.4 Checking If the ISP Settings are OK or Not.....	352
6.5 Problems for 3G Network Connection	355
6.6 Backing to Factory Default Setting If Necessary	356
6.7 Contacting Your Dealer	356

Appendix: Hardware Specifications.....357

Chapter 1: Preface

VigorIPPBX 2820 is an ADSL and broadband router with WAN interface. It provides policy-based load-balance, fail-over and BOD (Bandwidth on Demand), also it integrates IP layer QoS, NAT session/bandwidth management to help users control works well with large bandwidth.

By adopting hardware-based VPN platform and hardware encryption of AES/DES/3DS, the router increases the performance of VPN greatly, and offers several protocols (such as IPSec/PPTP/L2TP) with up to 32 VPN tunnels.



The object-based design used in SPI (Stateful Packet Inspection) firewall allows users to set firewall policy with ease. CSM (Content Security Management) provides users control and management in IM (Instant Messenger) and P2P (Peer to Peer) more efficiency than before. By the way, DoS/DDoS prevention and URL/Web content filter strengthen the security outside and control inside.

VigorIPPBX 2820 can provide up to 50 extensions setup to let all registered IP phones in LAN or remote sites around the world to have unlimited free calls through Internet. Moreover, VigorIPPBX 2820 is able to establish multiple networking architectures corresponding to your current desire and future needs of growing communication. Its ISDN/PSTN compatibility lets you move from simple VoIP solution such as IP phone and Softphone to integrate with comprehensive networking infrastructure, such as ISDN and Analog phone line any time you need.

Object-based firewall is flexible and allows your network be safe. In addition, through VoIP function, the communication fee for you and remote people can be reduced.

1.1 Web Configuration Buttons Explanation

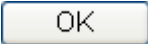
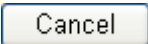
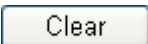
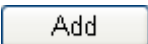
Several main buttons appeared on the web pages are defined as the following:

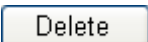
	Save and apply current settings.
	Cancel current settings and recover to the previous saved settings.
	Clear all the selections and parameters settings, including selection from drop-down list. All the values must be reset with factory default settings.
	Add new settings for specified item.
	Edit the settings for the selected item.
	Delete the selected item with the corresponding settings.

Note: For the other buttons shown on the web pages, please refer to Chapter 4 for detailed explanation.

1.2 LED Indicators and Connectors

Before you use the Vigor router, please get acquainted with the LED indicators and connectors first.

The displays of LED indicators and connectors for the routers are different slightly. The following sections will introduce them respectively. If the model of router you have does not support ISDN and/or VoIP function, simply ignore the relational description.

Definitions for ISDN Ports

Below shows the names that displayed on front panel of the device and the WEB UI of this device.

Both **ISDN1** and **ISDN2** port on front panel of the device are configurable for connecting phone or accessing Internet according to the settings that you adjust on WEB UI.

ISDN1-TE /ISDN2-TE (shown on WEB UI) is a port that used to connect ISDN line.

ISDN1-S0/ISDN2-S0 (shown on WEB UI) is a port that used to connect ISDN phone.

Please refer to **IP PBX>>PBX System>>Phone Settings** in this User's Guide for detailed information.



Warning: When the orange LED lights (means ISDN NT mode), the ISDN port can be used to connect phone only. Wrong ISDN connection might cause severe damage on your device.

1.2.1 For VigorIPPBX 2820

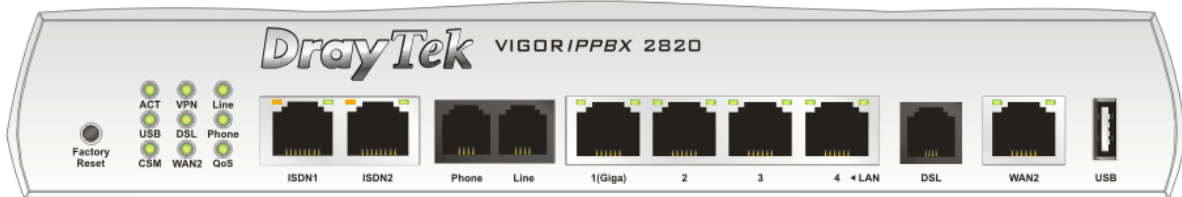

LED	Status	Explanation
ACT (Activity)	Blinking	The router is powered on and running normally.
	Off	The router is powered off.
USB	On	A USB device is connected and active.
	Blinking	The data is transmitting.
CSM	On	The profile of CSM (Content Security Management) for IM/P2P application is enabled from Firewall >> General Setup . (Such profile is established under CSM menu).
VPN	On	VPN tunnel is up and down.
DSL	On	The router is ready to access Internet through DSL link.
	Blinking	Slowly: The modem is ready. Quickly: The connection is training.
WAN 2	On	The WAN2 connection is ready.
	Blinking	It will blink while transmitting data.
Line	On	A PSTN phone call comes (in and out). However, when the phone call is disconnected, the LED will be off about six seconds later.
	Off	There is no PSTN phone call.
Phone	On	The phone connected to this port is off-hook.
	Off	The phone connected to this port is on-hook.
	Blinking	A phone call comes.
QoS	On	The QoS function is active.

LED on Connector

ISDN1/2	Left LED (Orange)	On	ISDN-S0 (ISDN-NT) mode is active configured from IP PBX>>PBX System>>Phone Settings and an ISDN phone adapter is connected.
		Blinking	ISDN S0 (ISDN-NT) mode configured from IP PBX>>PBX System>>Phone Settings is active and an ISDN phone adapter is not connected.
		Off	It means ISDN TE mode is active which is configured from IP PBX>>PBX System>>Phone Settings .
	Right LED (Green)	On	A phone adapter with phone set has been connected (ISDN-S0) or ISDN line has been connected (ISDN-TE).
		Blinking	ISDN-S0 (ISDN-NT) mode, it means an ISDN phone is off-hook or a phone call comes. In ISDN-TE mode, it means data, fax or voice (phone call) is transmitting.
		Off	It will be off if there is nothing connected.
LAN 1(Giga)	Left LED (Green)	On	The port is connected.
		Off	The port is disconnected.
		Blinking	The data is transmitting.
	Right LED (Green)	On	The port is connected with 1000Mbps.
		Off	The port is connected with 10/100Mbps.

LAN 2/3/4	Left LED (Green)	On	The port is connected.
		Off	The port is disconnected.
		Blinking	The data is transmitting.
	Right LED (Green)	On	The port is connected with 100Mbps.
		Off	The port is connected with 10Mbps.
		Blinking	The data is transmitting.
WAN 2	Left LED (Green)	On	The port is connected.
		Off	The port is disconnected.
		Blinking	The data is transmitting.
	Right LED (Green)	On	The port is connected with 100Mbps.
		Off	The port is connected with 10Mbps.
		Blinking	The data is transmitting.

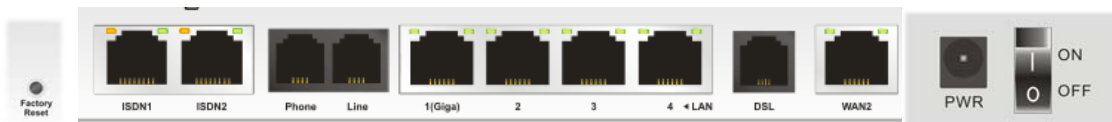

Interface	Description
Factory Reset	Restore the default settings. Usage: Turn on the router (ACT LED is blinking). Press the hole and keep for more than 5 seconds. When you see the ACT LED begins to blink rapidly than usual, release the button. Then the router will restart with the factory default configuration.
ISDN1/2	Connector for ISDN line or ISDN phone adapter in particular condition. Refer to section 2.2 for more details.
Phone	Connector for PSTN phone.
Line	Connector for PSTN life line.
LAN (1-4)	Connectors for local networked devices.
DSL	Connector for accessing the Internet through ADSL2/2+.
WAN 2	Connector for remote networked devices.
USB	Connector for a USB device (for 3G USB Modem or printer).
PWR	Connector for a power adapter.
ON/OFF	Power Switch.

1.2.2 For VigorIPPBX 2820n

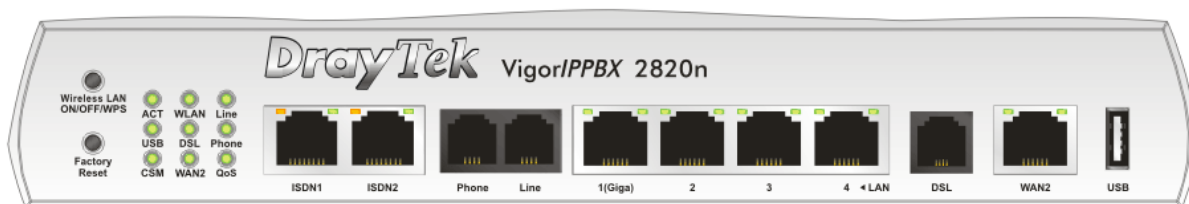

LED	Status	Explanation
ACT (Activity)	Blinking	The router is powered on and running normally.
	Off	The router is powered off.
USB	On	A USB device is connected and active.
	Blinking	The data is transmitting.
CSM	On	The profile of CSM (Content Security Management) for IM/P2P application is enabled from Firewall >> General Setup . (Such profile is established under CSM menu).
WLAN	On	Wireless access point is ready.
	Blinking	It will blink while wireless traffic goes through. If ACT and WLAN LEDs blink simultaneously when WPS is working, and it will return to normal condition after two minutes. (You need to setup WPS within 2 minutes.)
DSL	On	The router is ready to access Internet through DSL link.
	Blinking	Slowly: The modem is ready. Quickly: The connection is training.
WAN 2	On	The WAN2 connection is ready.
	Blinking	It will blink while transmitting data.
Line	On	A PSTN phone call comes (in and out). However, when the phone call is disconnected, the LED will be off about six seconds later.
	Off	There is no PSTN phone call.
Phone	On	The phone connected to this port is off-hook.
	Off	The phone connected to this port is on-hook.
	Blinking	A phone call comes.
QoS	On	The QoS function is active.

LED on Connector

ISDN1/2	Left LED (Orange)	On	ISDN-S0 (ISDN-NT) mode is active configured from IP PBX>>PBX System>>Phone Settings and an ISDN phone adapter is connected.
		Blinking	ISDN S0 (ISDN-NT) mode configured from IP PBX>>PBX System>>Phone Settings is active and an ISDN phone adapter is not connected.
		Off	It means ISDN TE mode is active which is configured from IP PBX>>PBX System>>Phone Settings .
	Right LED (Green)	On	A phone adapter with phone set has been connected (ISDN-S0) or ISDN line has been connected (ISDN-TE).
Blinking		ISDN-S0 (ISDN-NT) mode, it means an ISDN phone is off-hook or a phone call comes. In ISDN-TE mode, it means data, fax or voice (phone call) is transmitting.	

		Off	It will be off if there is nothing connected.
LAN 1(Giga)	Left LED (Green)	On	The port is connected.
		Off	The port is disconnected.
		Blinking	The data is transmitting.
	Right LED (Green)	On	The port is connected with 1000Mbps.
		Off	The port is connected with 10/100Mbps.
	LAN 2/3/4	Left LED (Green)	On
Off			The port is disconnected.
Blinking			The data is transmitting.
Right LED (Green)		On	The port is connected with 100Mbps.
		Off	The port is connected with 10Mbps.
WAN 2		Left LED (Green)	On
	Off		The port is disconnected.
	Blinking		The data is transmitting.
	Right LED (Green)	On	The port is connected with 100Mbps.
		Off	The port is connected with 10Mbps.



Interface	Description
Factory Reset	Restore the default settings. Usage: Turn on the router (ACT LED is blinking). Press the hole and keep for more than 5 seconds. When you see the ACT LED begins to blink rapidly than usual, release the button. Then the router will restart with the factory default configuration.
ISDN1/2	Connector for ISDN line or ISDN phone adapter in particular condition. Refer to section 2.2 for more details.
Phone	Connector for PSTN phone.
Line	Connector for PSTN life line.
LAN (1-4)	Connectors for local networked devices.
DSL	Connector for accessing the Internet through ADSL2/2+.
WAN 2	Connector for remote networked devices.
USB	Connector for a USB device (for 3G USB Modem or printer).
PWR	Connector for a power adapter.
ON/OFF	Power Switch.

1.3 Hardware Installation

Before starting to configure the router, you have to connect your devices correctly.

1. Connect the ADSL interface to the external ADSL splitter with an ADSL line cable. Also, connect Line interface to an external ADSL splitter.

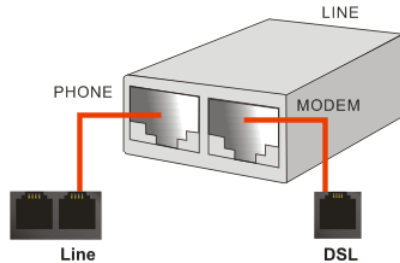

For second WAN, connect the cable Modem/DSL Modem/Media Converter to WAN2 port of router with Ethernet cable (RJ-45).

2. Connect one end of an Ethernet cable (RJ-45) to one of the LAN ports of the router and the other end of the cable (RJ-45) into the Ethernet port on your computer.

Note: It is strongly recommended to connect to Ethernet port on your computer with a shielding cable provided with the router.

3. Connect the telephone sets with phone lines (for using VoIP function). For the model without phone ports, skip this step.
4. Connect one end of the power adapter to the router's power port on the rear panel, and the other side into a wall outlet.
5. Power on the device by pressing down the power switch on the rear panel.
6. The system starts to initiate. After completing the system test, the ACT LED will light up and start blinking.

(For the detailed information of LED status, please refer to section 1.2.)

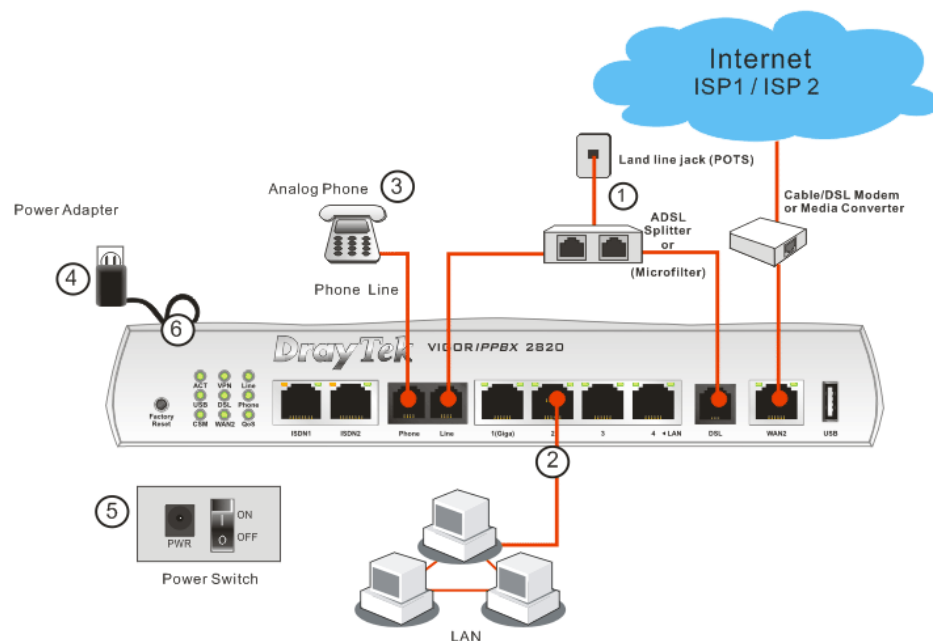

Caution: Each of the Phone ports can be connected to an analog phone only. Do not connect the phone ports to the telephone wall jack. Such connection might damage your router.

1.4 ISDN Phone Adapter Installation

ISDN1/2 port is configurable as NT or TE mode. When the user configures ISDN port as NT mode in **IP PBX>>PBX System>>Phone Settings**, the **orange** LED will light on to indicate **ISDN-NT** is selected. And by using ISDN phone adapters (coming from the router package), the user can connect several phones to the router for communication. Refer to the following figure for reference.

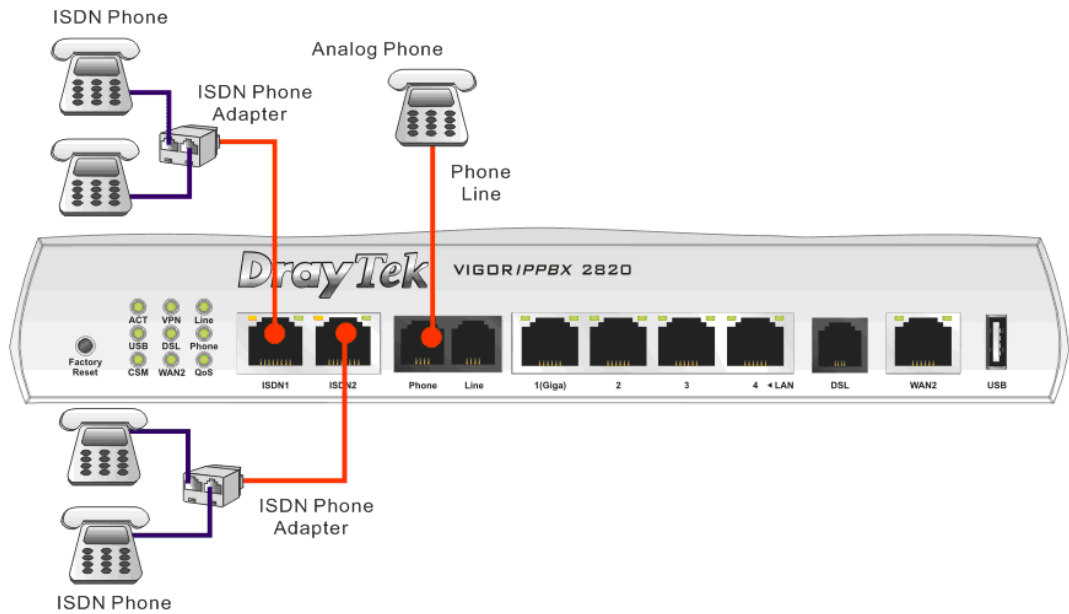

Yet, if the user configures ISDN port as TE Mode in **IP PBX>>PBX System>>Phone Settings**, the **green** LED will light on to indicate **ISDN-TE** is selected. Then, the port is specified for ISDN line only. Refer to the following figure for reference.

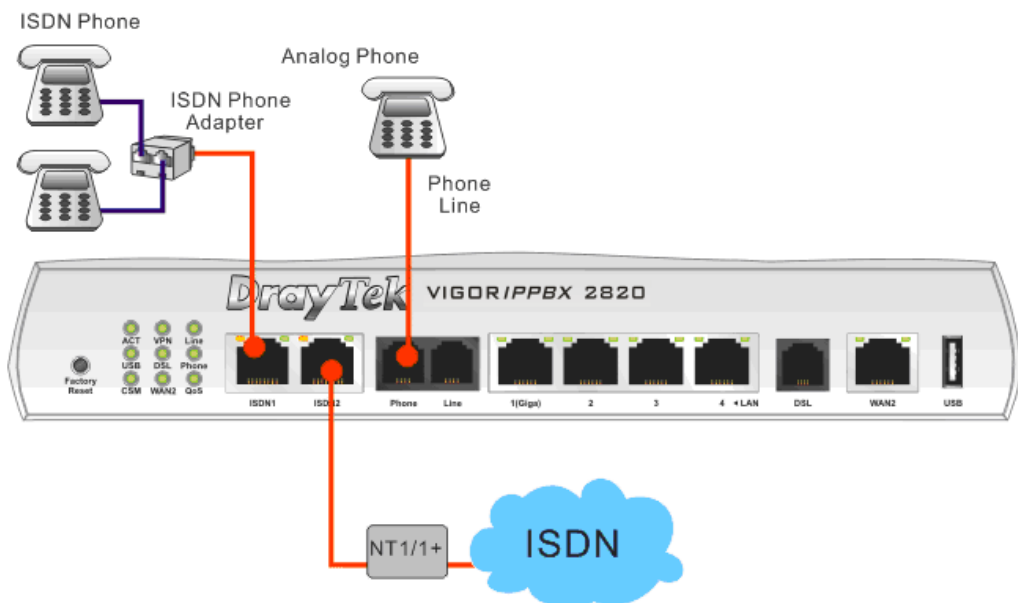

Note: ISDN Phone **MUST** be connected to ISDN port via an ISDN Phone Adapter. Do not connect the ISDN phone(s) to the ISDN port of the router directly for it cannot be used normally.

1.5 Printer Installation

You can install a printer onto the router for sharing printing. All the PCs connected this router can print documents via the router. The example provided here is made based on Windows XP/2000. For Windows 98/SE, please visit www.draytek.com.

Printer Name: 192.168.1.1
Port Name: IP_192.168.1.1

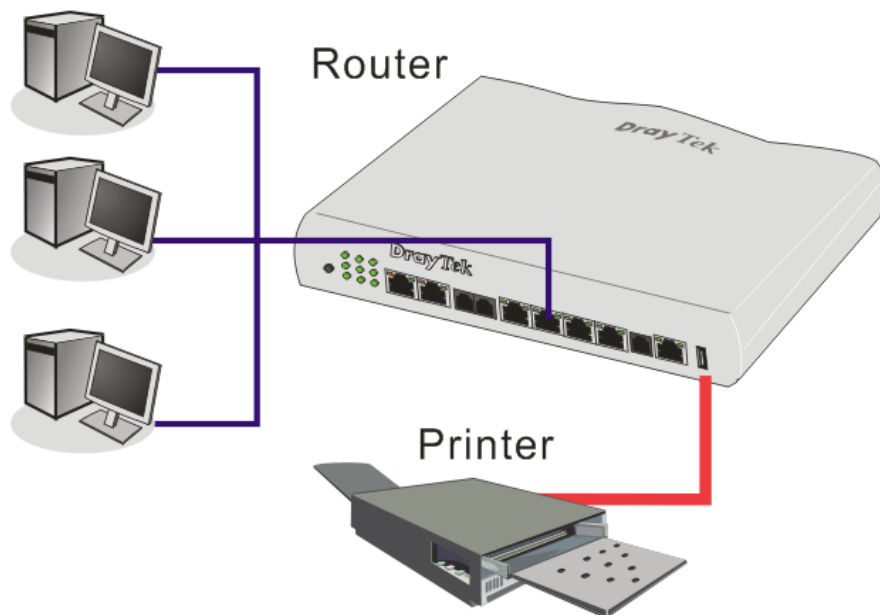

Before using it, please follow the steps below to configure settings for connected computers (or wireless clients).

1. Connect the printer with the router through USB/parallel port.
2. Open **Start>>Settings>> Printer and Faxes**.

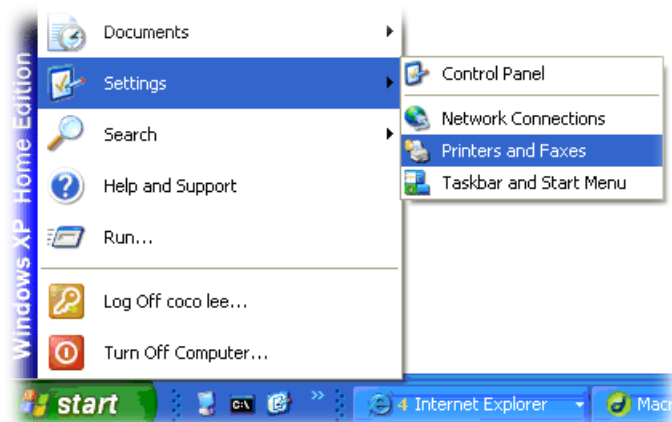

3. Open **File>>Add a New Computer**. A welcome dialog will appear. Please click **Next**.

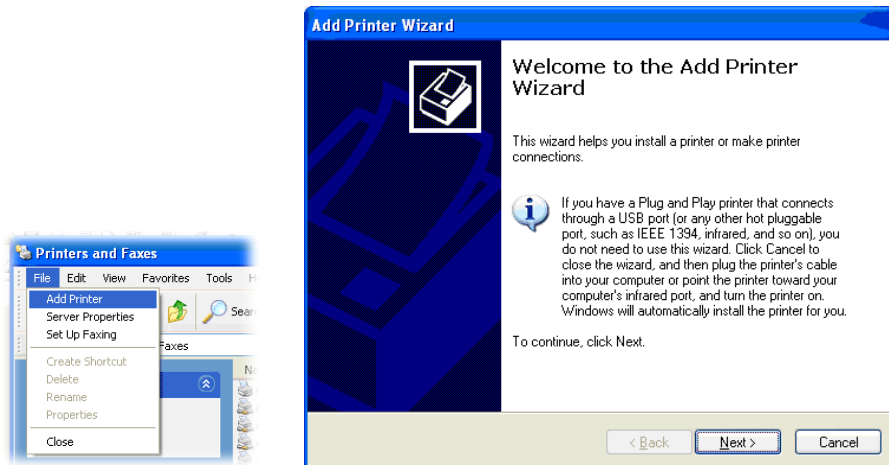

4. Click **Local printer attached to this computer** and click **Next**.

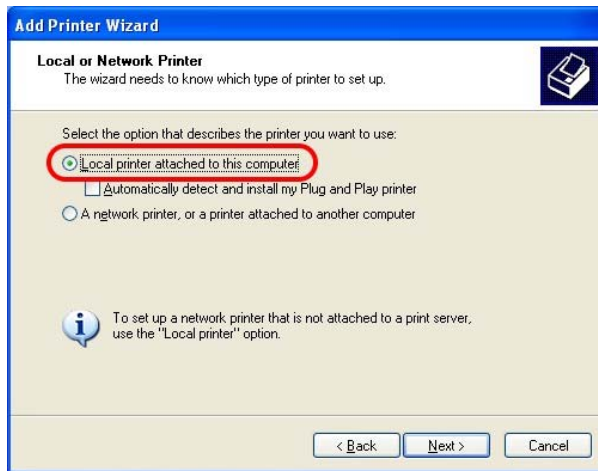

5. In this dialog, choose **Create a new port Type of port** and use the drop down list to select **Standard TCP/IP Port**. Click **Next**.

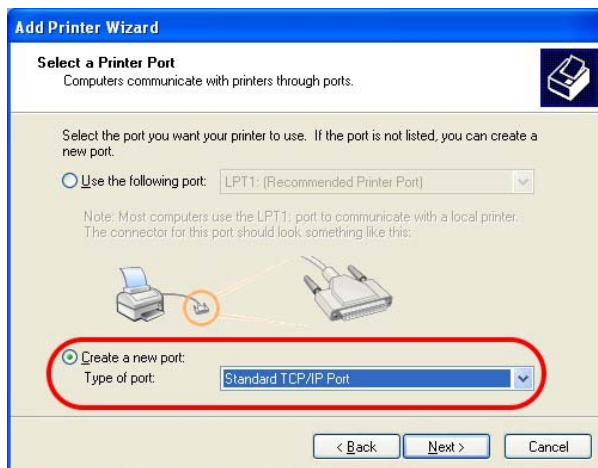

- In the following dialog, type **192.168.1.1** (router's LAN IP) in the field of **Printer Name or IP Address** and type **IP_192.168.1.1** as the port name. Then, click **Next**.

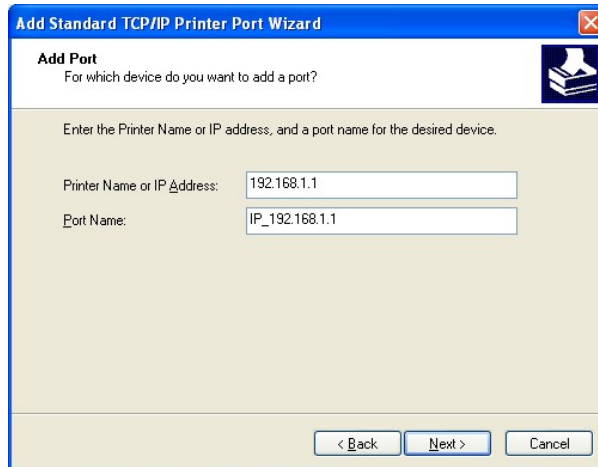

- Click **Standard** and choose **Generic Network Card**.

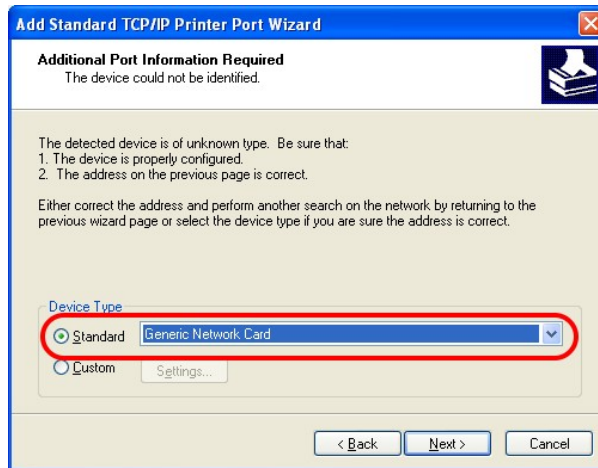

- Then, in the following dialog, click **Finish**.



9. Now, your system will ask you to choose right name of the printer that you installed onto the router. Such step can make correct driver loaded onto your PC. When you finish the selection, click **Next**.

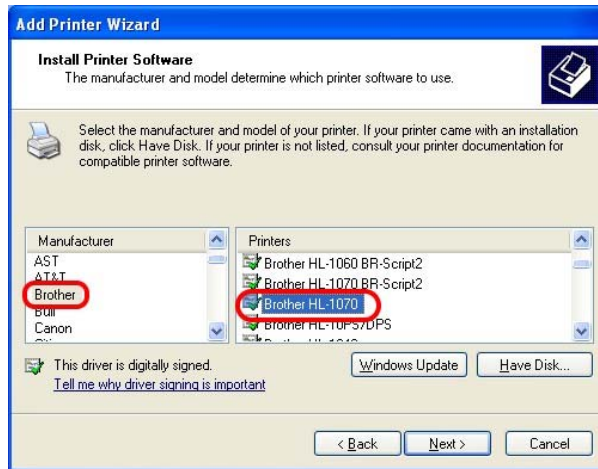

10. For the final stage, you need to go back to **Control Panel >> Printers** and edit the property of the new printer you have added.

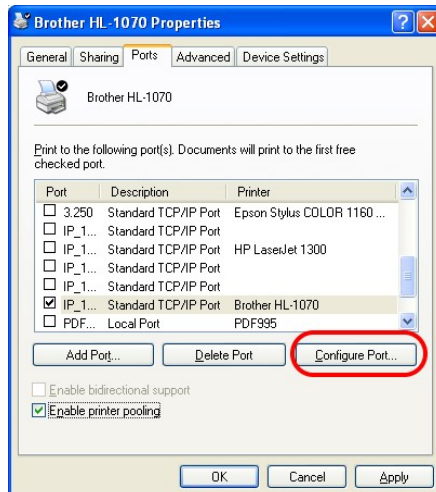

11. Select **LPR** on Protocol, type **p1** (number 1) as Queue Name. Then click **OK**. Next please refer to the red rectangle for choosing the correct protocol and UPR name.

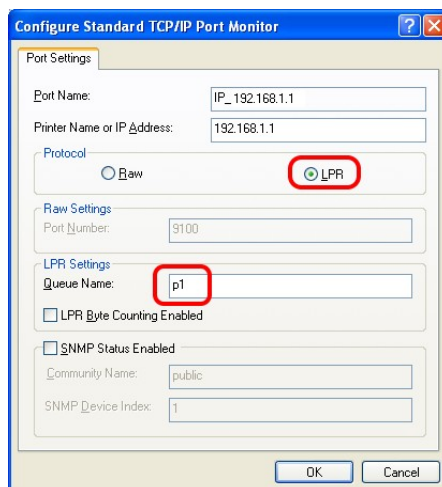

The printer can be used for printing now. Most of the printers with different manufacturers are compatible with vigor router.

Note 1: Some printers with the fax/scanning or other additional functions are not supported. If you do not know whether your printer is supported or not, please visit www.draytek.com to find out the printer list. Open **Support >>FAQ**; find out the link of **Printer Server** and click it; then click the **What types of printers are compatible with Vigor router?** link.

Home > Support > [FAQ](#)

FAQ - Basic

01. What are the differences among these firmware file formats ?
02. How could I get the telnet command for routers ?
03. How can I backup/restore my configuration settings ?
04. How do I reset/clear the router's password ?
05. How to bring back my router to its default value ?
06. How do I tell the type of my Vigor Router is AnnexA or AnnexB? (For ADSL model only)
07. Ways for firmware upgrade.
08. Why is SNMP removed in firmware 2.3.6 and above for Vigor2200 Series routers?
09. I failed to upgrade Vigor Router's firmware from my Mac machine constantly, what should I do?
10. How to upgrade firmware of Vigor Router remotely ?

FAQ

- Basic
- Advanced
- VPN
- DHCP
- Wireless
- VoIP
- QoS
- ISDN
- Firewall / IP Filter
- Printer Server**
- USB/ISDN TA
- USB

FAQ - Printer Server

01. How do I configure LPR printing on Windows2000/XP ?
02. How do I configure LPR printing on Windows98/Me ?
03. How do I configure LPR printing on Linux boxes ?
04. Why there are some strange print-out when I try to print my documents through Vigor210 4P / 2300's print server?
- 05. What types of printers are compatible with Vigor router?**
06. What are the limitations in the USB Printer Port of Vigor Router ?
07. What is the printing buffer size of Vigor Router ?
08. How do I configure LPR printing on Mac OSX ?
09. How do I configure LPR printing on My Windows Vista ?

Note 2: Vigor router supports printing request from computers via LAN ports but not WAN port.

This page is left blank.

Chapter 2: Configuring Basic Settings

For use the router properly, it is necessary for you to change the password of web configuration for security and adjust primary basic settings.

This chapter explains how to setup a password for an administrator, how to adjust basic settings for accessing Internet successfully and how to configure IPPBX settings via IPPBX wizard. Be aware that only the administrator can change the router configuration.

2.1 Changing Password

To change the password for this device, you have to access into the web browse with default password first.

1. Make sure your computer connects to the router correctly.



Notice: You may either simply set up your computer to get IP dynamically from the router or set up the IP address of the computer to be the same subnet as **the default IP address of Vigor router 192.168.1.1**. For the detailed information, please refer to the later section - Trouble Shooting of this guide.

2. Open a web browser on your PC and type **http://192.168.1.1**. A pop-up window will open to ask for username and password. Please type “admin” as the username and leave blank for the password on the window. Next click **OK** for next screen.



- Now, the **Main Screen** will pop up.

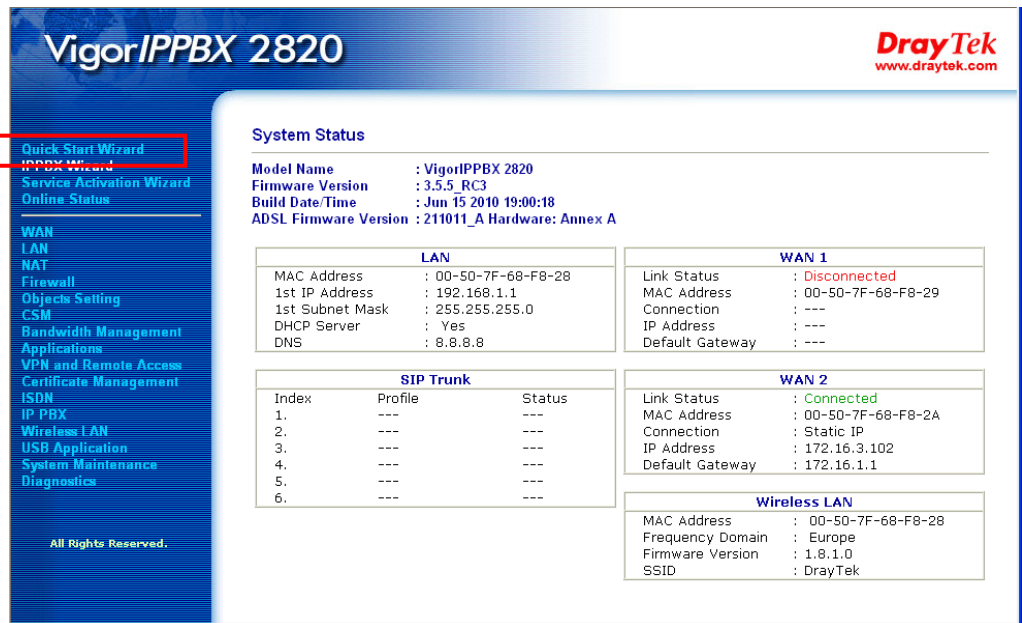

Note: The home page will change slightly in accordance with the router you have.

- Go to **System Maintenance** page and choose **Administrator Password**.

[System Maintenance >> Administrator Password Setup](#)

Administrator Password

Old Password	<input type="text"/>
New Password	<input type="text"/>
Confirm Password	<input type="text"/>

- Enter the login password (the default is blank) on the field of **Old Password**. Type **New Password**. Then click **OK** to continue.
- Now, the password has been changed. Next time, use the new password to access the Web Configurator for this router.



2.2 Quick Start Wizard

If your router can be under an environment with high speed NAT, the configuration provide here can help you to deploy and use the router quickly. The first screen of **Quick Start Wizard** is entering login password. After typing the password, please click **Next**.

Quick Start Wizard

Enter login password

Please enter an alpha-numeric string as your **Password** (Max 23 characters).

New Password

Confirm Password

On the next page as shown below, please select the WAN interface (WAN 1 or WAN2) that you use. If DSL interface is used, please choose WAN1; if WAN2 interface is used, please choose WAN2. Choose **Auto negotiation** as the physical type for your router. Then click **Next** for next step.

Quick Start Wizard

WAN Interface

WAN Interface:

Display Name:

Physical Mode:

Physical Type:

On the next page as shown below, please select the appropriate Internet access type according to the information from your ISP. For example, you should select PPPoE mode if the ISP provides you PPPoE interface. Then click **Next** for next step.

Quick Start Wizard

Connect to Internet

WAN 1

VPI	<input type="text" value="0"/>	<input type="button" value="Auto detect"/>
VCI	<input type="text" value="33"/>	
Protocol / Encapsulation	PPPoE LLC/SNAP	
Fixed IP	<input type="radio"/> Yes <input checked="" type="radio"/> No(Dynamic IP)	
IP Address	<input type="text"/>	
Subnet Mask	<input type="text"/>	
Default Gateway	<input type="text"/>	
Primary DNS	<input type="text"/>	
Second DNS	<input type="text"/>	

PPPoE LLC/SNAP

- PPPoE LLC/SNAP
- PPPoE VC MUX
- PPPoA LLC/SNAP
- PPPoA VC MUX
- 1483 Bridged IP LLC
- 1483 Routed IP LLC
- 1483 Bridged IP VC-Mux
- 1483 Routed IP VC-Mux (IPoA)
- 1483 Bridged IP (IPoE)

In the **Quick Start Wizard**, you can configure the router to access the Internet with different protocol/modes such as **PPPoE/PPPoA**, **1483 Bridged IP** or **1483 Routed IP**. The router supports the DSL WAN interface for Internet access.

2.2.1 PPPoE/PPPoA

PPPoE stands for **Point-to-Point Protocol over Ethernet**. It relies on two widely accepted standards: PPP and Ethernet. It connects users through an Ethernet to the Internet with a common broadband medium, such as a single DSL line, wireless device or cable modem. All the users over the Ethernet can share a common connection.

PPPoE is used for most of DSL modem users. All local users can share one PPPoE connection for accessing the Internet. Your service provider will provide you information about user name, password, and authentication mode.

If your ISP provides you the **PPPoE** connection, please select **PPPoE** for this router. The following page will be shown:

Quick Start Wizard

Set PPPoE / PPPoA

WAN 1	
User Name	<input type="text" value="84005756@hinet.net"/>
Password	<input type="password" value="••••••••"/>
Confirm Password	<input type="password" value="••••••••"/>

User Name Assign a specific valid user name provided by the ISP.

Password Assign a valid password provided by the ISP.

Confirm Password Retype the password.

Click **Next** for viewing summary of such connection.

Quick Start Wizard

Please confirm your settings:

WAN Interface:	WAN1
Physical Mode:	ADSL
Physical Type:	Auto negotiation
VPI:	8
VCI:	35
Protocol / Encapsulation:	PPPoA / VCMUX
Fixed IP:	No
Primary DNS:	undefined
Secondary DNS:	undefined

Click **Finish**. A page of **Quick Start Wizard Setup OK!!!** will appear. Then, the system status of this protocol will be shown.

Quick Start Wizard Setup OK !!!

2.2.2 1483 Bridged IP

Click **1483 Bridged IP** as the protocol. Type in all the information that your ISP provides for this protocol.

Quick Start Wizard

Connect to Internet

WAN 1	
VPI	<input type="text" value="0"/> <input type="button" value="Auto detect"/>
VCI	<input type="text" value="33"/>
Protocol / Encapsulation	<input type="text" value="1483 Bridged IP LLC"/> ▾
Fixed IP	<input type="radio"/> Yes <input checked="" type="radio"/> No(Dynamic IP)
IP Address	<input type="text"/>
Subnet Mask	<input type="text"/>
Default Gateway	<input type="text"/>
Primary DNS	<input type="text" value="168.95.1.1"/>
Second DNS	<input type="text"/>

Click **Next** for viewing summary of such connection.

Quick Start Wizard

Please confirm your settings:

WAN Interface:	WAN1
Physical Mode:	ADSL
Physical Type:	Auto negotiation
VPI:	0
VCI:	33
Protocol / Encapsulation:	1483 Bridge LLC
Fixed IP:	No
Primary DNS:	168.95.1.1
Secondary DNS:	

Click **Finish**. A page of **Quick Start Wizard Setup OK!!!** will appear. Then, the system status of this protocol will be shown.

Quick Start Wizard Setup OK !!!

2.2.3 1483 Routed IP

Click **1483 Routed IP** as the protocol. Type in all the information that your ISP provides for this protocol.

Quick Start Wizard

Connect to Internet

WAN 1	
VPI	<input type="text" value="8"/> <input type="button" value="Auto detect"/>
VCI	<input type="text" value="35"/>
Protocol / Encapsulation	<input type="text" value="1483 Routed IP LLC"/>
Fixed IP	<input checked="" type="radio"/> Yes <input type="radio"/> No(Dynamic IP)
IP Address	<input type="text" value="192.168.3.10"/>
Subnet Mask	<input type="text" value="255.255.255.0"/>
Default Gateway	<input type="text" value="192.168.3.1"/>
Primary DNS	<input type="text" value="undefined"/>
Second DNS	<input type="text" value="undefined"/>

After finishing the settings in this page, click **Next** to see the following page.

Quick Start Wizard

Please confirm your settings:

WAN Interface:	WAN1
Physical Mode:	ADSL
Physical Type:	Auto negotiation
VPI:	8
VCI:	35
Protocol / Encapsulation:	1483 Route LLC
Fixed IP:	Yes
IP Address:	192.168.3.10
Subnet Mask:	255.255.255.0
Default Gateway:	192.168.3.1
Primary DNS:	undefined
Secondary DNS:	undefined

Click **Finish**. A page of **Quick Start Wizard Setup OK!!!** will appear. Then, the system status of this protocol will be shown.

Quick Start Wizard Setup OK !!!

2.3 IPPBX Wizard

IPPBX Wizard can guide the user to configure the required settings for this router within several steps. All the settings, also, can be configured by using **IP PBX** menu. However, the wizard is the most convenient and easy method for users.

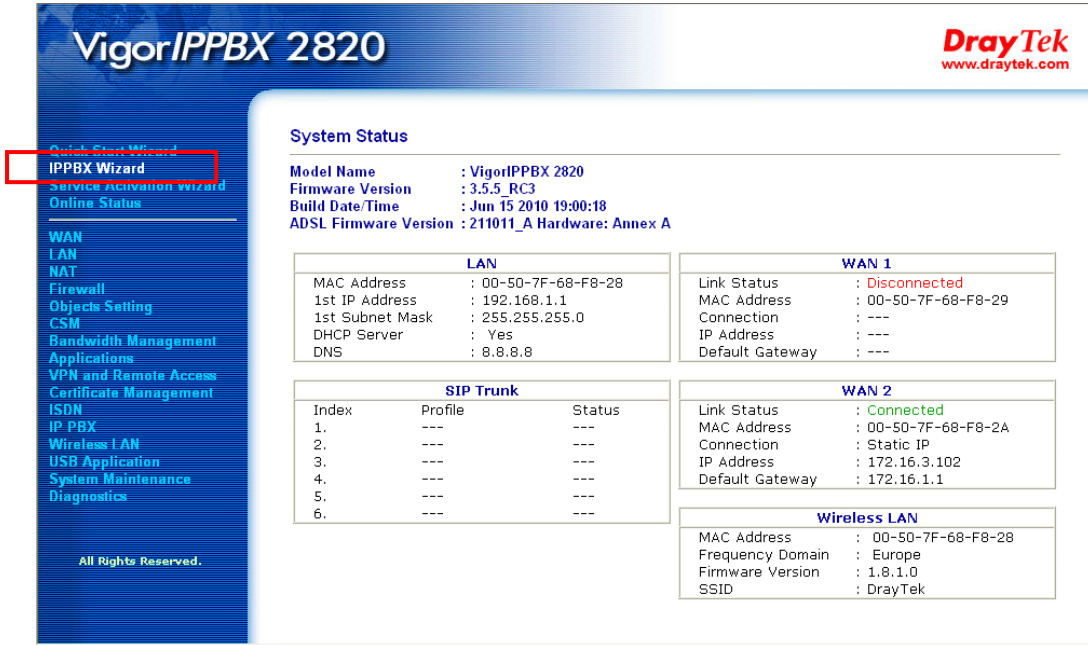

2.3.1 Extension & Group Setup

Click **IPPBX Wizard**. You can get the first screen as shown below.

IPPBX Wizard

Extension & Groups Setup : Index 1

Extension Group Name:	<input type="text"/>	(for example : sales)
Extension Group Number:	<input type="text"/>	(for example : 100)
Start Number of the extension Group:	<input type="text"/>	(for example : 101)
Number of extensions in this group:	<input type="text"/>	(for example : 10, max = 20)
Extension Password in this group:	<input type="text"/>	
<input type="button" value="OK"/>		

Index	Group Name	Group Extension	Hunt List(Max 20 Extension)
1.			
2.			
3.			
4.			
5.			
6.			
7.			
8.			
9.			
10.			

Extension Group Name

Type a name as a display for this extension group.

- Extension Group Number** Type the number of extension for such group.
- Start Number of the extension Group** Type the start extension number for such group.
- Number of extension in this group** Type the total number of the extension for such group.
- Extension Password in this group** Type the password for this extension group, which will be used in registration done by IP Phone.

When you finish the settings of group name, group number, start number, number of extension fields, please click **OK** to save them. The new added group will be displayed on the screen. You can set 10 groups for using in different conditions. Then click **Next** to access into next web page.

Below shows an example for your reference:

IPPBX Wizard

Extension & Groups Setup : Index 5

Extension Group Name:	<input type="text" value="TSS"/>	(for example : sales)
Extension Group Number:	<input type="text" value="205"/>	(for example : 100)
Start Number of the extension Group:	<input type="text" value="2051"/>	(for example : 101)
Number of extensions in this group:	<input type="text" value="4"/>	(for example : 10, max = 20)
Extension Password in this group:	<input type="password"/>	
<input type="button" value="OK"/>		

Index	Group Name	Group Extension	Hunt List(Max 20 Extension)
1.	SMB E	201	2011-2015
2.	SMB W	202	2021-2026
3.	Gov C	203	2031-2037
4.	Healthcare	204	2041-2043
5.	TSS	205	2051-2054
6.			
7.			
8.			
9.			
10.			

2.3.2 SIP Trunk Setup

This page allows you to set profiles for six SIP outside lines at one time.

IPPBX Wizard

Sip Trunk Setup : Index 1

Profile Name:	<input type="text"/>	(11 characters max.)
Domain/Realm:	<input type="text"/>	(63 characters max.)
Proxy:	<input type="text"/>	(63 characters max.)
Account Number/Name:	<input type="text"/>	(63 characters max.)
Password:	<input type="text"/>	(63 characters max.)
Trunk number:	<input type="text" value="001"/>	(3 characters max.)
<input type="button" value="OK"/>		

Index	Profile Name	Domain/Realm	Proxy	Account Number/Name	Trunk Number
1.					001
2.					002
3.					003
4.					004
5.					005
6.					006

Profile Name

Type a name for this profile for identifying.

Domain/Realm

Set the domain name or IP address of the SIP Registrar server.

Proxy

Set domain name or IP address of SIP proxy server. By the time you can type **:port number** after the domain name to specify that port as the destination of data transmission (e.g., **nat.draytel.org:5065**)

Account Number/Name

Enter your account name of SIP Address, e.g. every text before @.

Password

Type the password which will be used in registration for SIP service for this profile.

Trunk Number

There are two ways to dial outside lines for an extension number. First, dial a short number and wait for a while. When dial tone appears, please dial the real outside line number. Second, dial a short number and then the real outside line number without waiting for dial tone. The short number is defined here as Trunk Number.

When you finish the settings of profile name, domain/realm, proxy, account number/name, password and trunk number fields, please click **OK** to save them. The new added profile will be displayed on the screen.

Index	Profile Name	Domain/Realm	Proxy	Account Number/Name	Trunk Number
1.	SalesMarket	192.168.1.55	nat.draytel.org:5065	salesgroup	001
2.					002
3.					003
4.					004
5.					005
6.					006

You can set 6 profiles for using in different conditions. Then click **Next** to access into next web page.

2.3.3 Office Hours Setup

This page allows you to set office hours including starting point, ending point on duty day(s).

IPPBX Wizard

Office Hours Setup

Now, You can make the work time schedule of your office.

	Hour :	Min
When do you start working in the morning	00 ▾	00 ▾
When do you have a rest at noon	00 ▾	00 ▾
When do you start working in the afternoon	00 ▾	00 ▾
When do you leave the office	00 ▾	00 ▾
Is this schedule available at weekend?	<input type="radio"/> Yes <input checked="" type="radio"/> No	

- When do you start working in the morning** Use the drop down menu to choose the time as the starting point in the morning.
- When do you have a rest at noon** Use the drop down menu to choose the time as the ending point in the morning.
- When do you start working in the afternoon** Use the drop down menu to choose the time as the starting point in the afternoon.
- When do you leave the office** Use the drop down menu to choose the time as the ending point in the afternoon.
- Is this schedule available at the weekend** If such schedule will be available in the weekend, simply click **Yes**, otherwise, click **No**.

When you finish the settings, click **Finish** to save the settings and exit the wizard.

work time schedule of your office.

	Hour :	Min
ing in the morning	08 ▾	00 ▾
st at noon	12 ▾	00 ▾
ing in the afternoon	13 ▾	00 ▾
office	17 ▾	30 ▾
e at weekend?	<input type="radio"/> Yes	<input checked="" type="radio"/> No

< Back Next > Finish Cancel

2.4 Service Activation Wizard

Service Activation Wizard can guide you to set WCF (Web Content Feature) feature with a quick way.

Note: There are three ways to activate WCF on vigor router, using **Service Activation Wizard**, by means of **CSM>>Web Content Filter Profile** or via **System Maintenance>>Activation**.

Service Activation Wizard is a tool which allows you to use trial version or update the license of WCF directly without accessing into the server (**MyVigor**) located on <http://myvigor.draytek.com>. For using Web Content Filter Profile, please refer to section **5.6.3 Web Content Filter Profile** for detailed information.

Now, please follow the steps listed below to activate WCF feature for your router.

1. Open **Service Activation Wizard**.

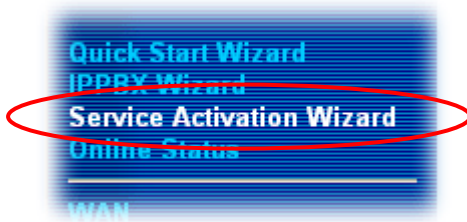

2. The screen of **Service Activation Wizard** will be shown as follows. Choose the one you need and click **Next**. In this case, we choose to activate free trial edition.

Service Activation Wizard

Select the service type that you want to activate

This wizard is used for activating
- Web Content Filter
Please choose the edition you need.

- Free trial edition
 Formal edition with license key

Next >

Finish

Cancel

Free trial edition: it offers a period of trial for you to get acquainted with WCF function.

Formal edition with license key: you can extend the license valid time manually.

Note: If you activate **Formal edition with license key** first, the free trial edition will be invalid.

3. In the following page, you can activate the Web content filter service at the same time or individually. When you finish the selection, please click **Next**.

Service Activation Wizard

Select the service type that you want to activate

This product provides 30 days of free trial, please choose the item(s) you want to use.

For WCF service:

Web Content Filter (CT-CF) [License Agreement](#) Activation Date :

4. Setting confirmation page will be displayed as follows, please click **Next**.

Service Activation Wizard

Please confirm your settings

Service Type : Trial version
Service Activated : Web Content Filter (CT-CF)

Please click **Back** to re-select service type you to activate.

5. Wait for a moment till the following page appears.

Service Activation Wizard

Connection Succeeded!

Please check the following item(s) to enable the AI/AV or WCF or AS services on your router.

Enable Web Content Filter

When such page appears, you can enable or disable these services for your necessity. Then, click **Finish**.

Note: The service will be activated and applied as the default rule configured in **Firewall>>General Setup**.

- Now, the web page will display the service that you have activated according to your selection(s). The valid time for the free trial of these services is one month.

Service Activation Wizard

Server Enabled!

DrayTek Service Activation

Service Name	Start Date	Expire Date	Status
Web Content filter	2010-03-15	2010-04-15	CT-CF

Please check if the license fits with the service provider of your signature. To ensure normal operation for your router, update your signature again is recommended.

Copyright © DrayTek Corp. All Rights Reserved.

Later, if you need to extend the license valid time, you can also use the **Service Activation Wizard** again to reach your goal by clicking the radio button of **Formal edition with license key** and clicking **Next**.

Service Activation Wizard

Select the service type that you want to activate

This wizard is used for activating
- Web Content Filter
Please choose the edition you need.

Free trial edition
 Formal edition with license key

Service Activation Wizard

Select the service type that you want to activate

Please choose the item you want to use.

For WCF service:

Web Content Filter (CT-CF)
 [License Agreement](#)
Activation Date : [select](#)

Enter your License key:

I have read and accept the above Agreement.(Please check this box.)

Note :The activation date is brought out by the server automatically and cannot be changed.

2.5 Online Status

The online status shows the system status, WAN status, ADSL Information and other status related to this router within one page. If you select **PPPoE/PPPoA** as the protocol, you will find out a link of **Dial PPPoE** or **Drop PPPoE** in the Online Status web page.

Online status for PPPoE (WAN2)

Online Status

System Status		System Uptime: 3:18:44				
Primary		Secondary				
LAN Status		Primary DNS: 192.168.66.1		Secondary DNS: 168.95.1.1		
IP Address	TX Packets	RX Packets				
192.168.1.1	749	552				
WAN 1 Status >>> Release						
Enable	Line	Name	Mode	Up Time		
Yes	ADSL		DHCP Client	0:00:00		
IP	GW IP	TX Packets	TX Rate(Bps)	RX Packets	RX Rate(Bps)	
192.168.66.10	192.168.66.1	1	9	1	0	
WAN 2 Status >>> Drop PPPoE						
Enable	Line	Name	Mode	Up Time		
Yes	Ethernet		PPPoE	0:00:22		
IP	GW IP	TX Packets	TX Rate(Bps)	RX Packets	RX Rate(Bps)	
218.160.234.238	61.216.116.254	14	16	15	41	
ADSL Information (ADSL Firmware Version: 211011_A)						
ATM Statistics	TX Blocks	RX Blocks	Corrected Blocks	Uncorrected Blocks		
	18	23	0	0		
ADSL Status	Mode	State	Up Speed	Down Speed	SNR Margin	Loop Att.
	G.DMT	SHOWTIME	1024000	11936000	0	0

Online status for PPTP (for WAN2)

Online Status

System Status		System Uptime: 3:18:44				
Primary		Secondary				
LAN Status		Primary DNS: 168.95.1.1		Secondary DNS: 168.95.1.1		
IP Address	TX Packets	RX Packets				
192.168.1.1	480	339				
WAN 1 Status						
Enable	Line	Name	Mode	Up Time		
Yes	ADSL		Static IP	0:00:00		
IP	GW IP	TX Packets	TX Rate(Bps)	RX Packets	RX Rate(Bps)	
192.168.66.52	192.168.66.1	1	9	1	16	
WAN 2 Status >>> Release						
Enable	Line	Name	Mode	Up Time		
Yes	Ethernet		PPTP	0:00:28		
IP	GW IP	TX Packets	TX Rate(Bps)	RX Packets	RX Rate(Bps)	
192.168.129.11	192.168.129.1	8	12	10	9	
ADSL Information (ADSL Firmware Version: 211011_A)						
ATM Statistics	TX Blocks	RX Blocks	Corrected Blocks	Uncorrected Blocks		
	4	3	0	2		
ADSL Status	Mode	State	Up Speed	Down Speed	SNR Margin	Loop Att.
	G.DMT	SHOWTIME	1024000	12000000	8	0

Online status for Static IP (for WAN1)

Online Status

System Status						System Uptime: 3:18:44
Primary			Secondary			
LAN Status		Primary DNS: 168.95.1.1		Secondary DNS: 168.95.1.1		
IP Address	TX Packets	RX Packets				
192.168.1.1	480	339				
WAN 1 Status						
Enable	Line	Name	Mode	Up Time		
Yes	ADSL		Static IP	0:00:00		
IP	GW IP	TX Packets	TX Rate(Bps)	RX Packets	RX Rate(Bps)	
192.168.66.52	192.168.66.1	1	9	1	16	
WAN 2 Status						>> Release
Enable	Line	Name	Mode	Up Time		
Yes	Ethernet		PPTP	0:00:28		
IP	GW IP	TX Packets	TX Rate(Bps)	RX Packets	RX Rate(Bps)	
192.168.129.11	192.168.129.1	8	12	10	9	
ADSL Information (ADSL Firmware Version: 211011_A)						
ATM Statistics	TX Blocks	RX Blocks	Corrected Blocks	Uncorrected Blocks		
	4	3	0	2		
ADSL Status	Mode	State	Up Speed	Down Speed	SNR Margin	Loop Att.
	G.DMT	SHOWTIME	1024000	12000000	8	0

Online status for DHCP (WAN1)

Online Status

System Status						System Uptime: 3:18:44
Primary			Secondary			
LAN Status		Primary DNS: 192.168.66.1		Secondary DNS: 168.95.1.1		
IP Address	TX Packets	RX Packets				
192.168.1.1	749	552				
WAN 1 Status						
Enable	Line	Name	Mode	Up Time		
Yes	ADSL		DHCP Client	0:00:00		
IP	GW IP	TX Packets	TX Rate(Bps)	RX Packets	RX Rate(Bps)	
192.168.66.10	192.168.66.1	1	9	1	0	
WAN 2 Status						>> Drop PPPoE
Enable	Line	Name	Mode	Up Time		
Yes	Ethernet		PPPoE	0:00:22		
IP	GW IP	TX Packets	TX Rate(Bps)	RX Packets	RX Rate(Bps)	
218.160.234.238	61.216.116.254	14	16	15	41	
ADSL Information (ADSL Firmware Version: 211011_A)						
ATM Statistics	TX Blocks	RX Blocks	Corrected Blocks	Uncorrected Blocks		
	18	23	0	0		
ADSL Status	Mode	State	Up Speed	Down Speed	SNR Margin	Loop Att.
	G.DMT	SHOWTIME	1024000	11936000	0	0

Online status for ISDN enabled

Enable	Line	Name	Mode	Up Time			
Yes	Ethernet		Static IP	00:00:00			
IP	GW IP	TX Packets	TX Rate(Bps)	RX Packets	RX Rate(Bps)		
172.17.3.43	172.17.3.2	0	0	0	0		
ADSL Information (ADSL Firmware Version: 2121501_A)							
ATM Statistics	TX Blocks	RX Blocks	Corrected Blocks	Uncorrected Blocks			
	0	0	0	0			
ADSL Status	Mode	State	Up Speed	Down Speed	SNR Margin	Loop Att.	
	-----	READY	0	0	0	0	
ISDN Status							
				>> Dial ISDN >>	>> Drop B1 >>	>> Drop B2	
Channel	Active Connection	TX Pkts	TX Rate (Bps)	RX Pkts	RX Rate (Bps)	Up Time	AOC
ISDN1-B1	Idle [---]	0	0	0	0	0:0:0	0
ISDN1-B2	Idle [---]	0	0	0	0	0:0:0	0
ISDN1-D	UP						
ISDN2-B1	2930 [192.168.3.10]	19	9	10	3	0:0:36	0
ISDN2-B2	Idle [---]	0	0	0	0	0:0:0	0
ISDN2-D	UP						

Detailed explanation is shown below:

Primary DNS Displays the IP address of the primary DNS.

Secondary DNS Displays the IP address of the secondary DNS.

LAN Status

IP Address Displays the IP address of the LAN interface.

TX Packets Displays the total transmitted packets at the LAN interface.

RX Packets Displays the total number of received packets at the LAN interface.

WAN1/2 Status

Line Displays the physical connection (Ethernet) of this interface.

Name Displays the name set in WAN1/WAN web page.

Mode Displays the type of WAN connection (e.g., PPPoE).

Up Time Displays the total uptime of the interface.

IP Displays the IP address of the WAN interface.

GW IP Displays the IP address of the default gateway.

TX Packets Displays the total transmitted packets at the WAN interface.

TX Rate Displays the speed of transmitted octets at the WAN interface.

RX Packets Displays the total number of received packets at the WAN interface.

RX Rate Displays the speed of received octets at the WAN interface.

ISDN Status

Channel Active Conn. Displays the active connection status for each channel.

TX Pkts Displays the total transmitted packets at the ISDN interface.

TX Rate Displays the speed of transmitted octets at the ISDN interface.

RX Pkts	Displays the total number of received packets at the ISDN interface.
RX Rate	Displays the speed of received octets at the ISDN interface.
Up Time	Displays the total uptime of the interface.
AOC	Displays the charge information of the interface.

Note: The words in green mean that the WAN connection of that interface (WAN1/WAN2) is ready for accessing Internet; the words in red mean that the WAN connection of that interface (WAN1/WAN2) is not ready for accessing Internet.

2.6 Saving Configuration

Each time you click **OK** on the web page for saving the configuration, you can find messages showing the system interaction with you.

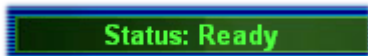

Status: Ready

Ready indicates the system is ready for you to input settings.

Settings Saved means your settings are saved once you click **Finish** or **OK** button.

This page is left blank.

Chapter 3: Applications

This chapter shows several scenarios for your reference to configure IP PBX for different purposes.

3.1 The Registration of 50 IP-based Telephone/Extensions

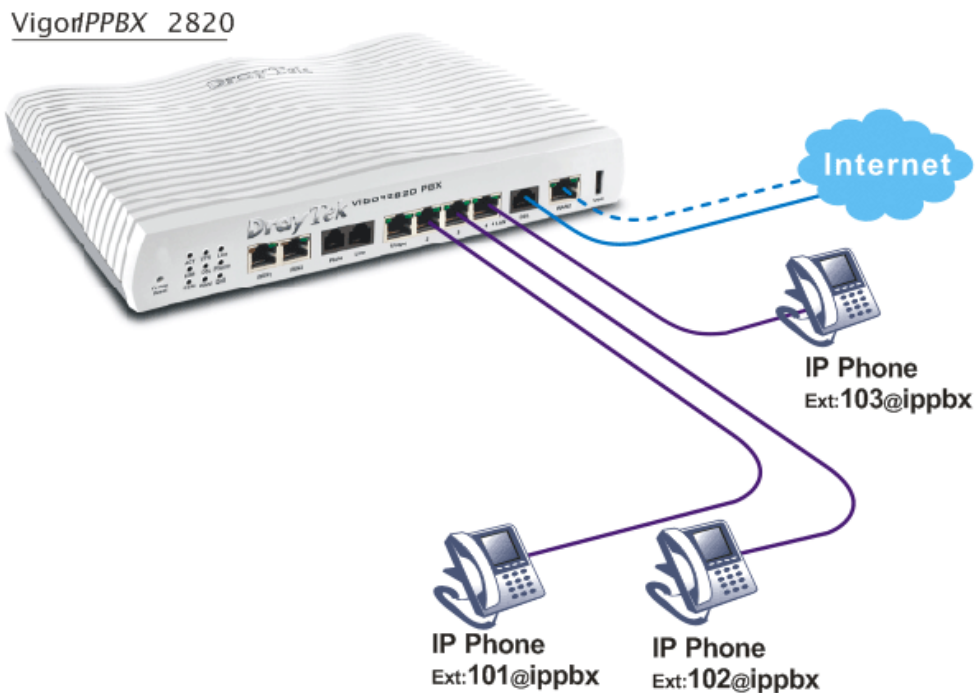

- The establishment through DSL Internet.
- Flexible second WAN for back-up.
- IP-based telephones are connected to LAN ports and set with ext. no. 101, 102 & 103.
- The IP-based telephones (101, 102, and 103) are registered on the VigorIPPBX 2820.

3.2 The IP Registration from Remote Site (through WAN Connection)

VigorIPPBX 2820

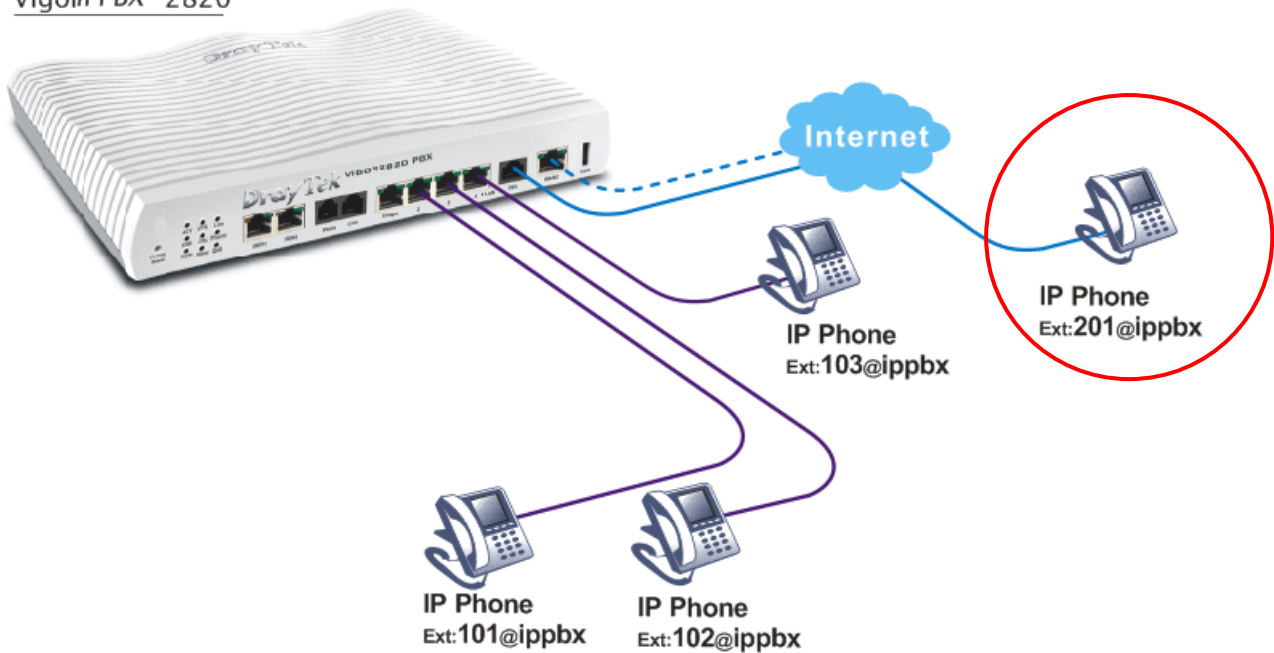

- The establishment through DSL Internet.
- Flexible second WAN for back-up.
- IP-based telephones are connected to LAN ports and set with ext. no. 101, 102 & 103.
- The IP-based telephones (101, 102, and 103) and remote IP-based phone are registered on the VigorIPPBX 2820.
- **The IP-based phone with ext. no. 201 is at remote site.**

3.3 The Integration IP Registration with SIP Server

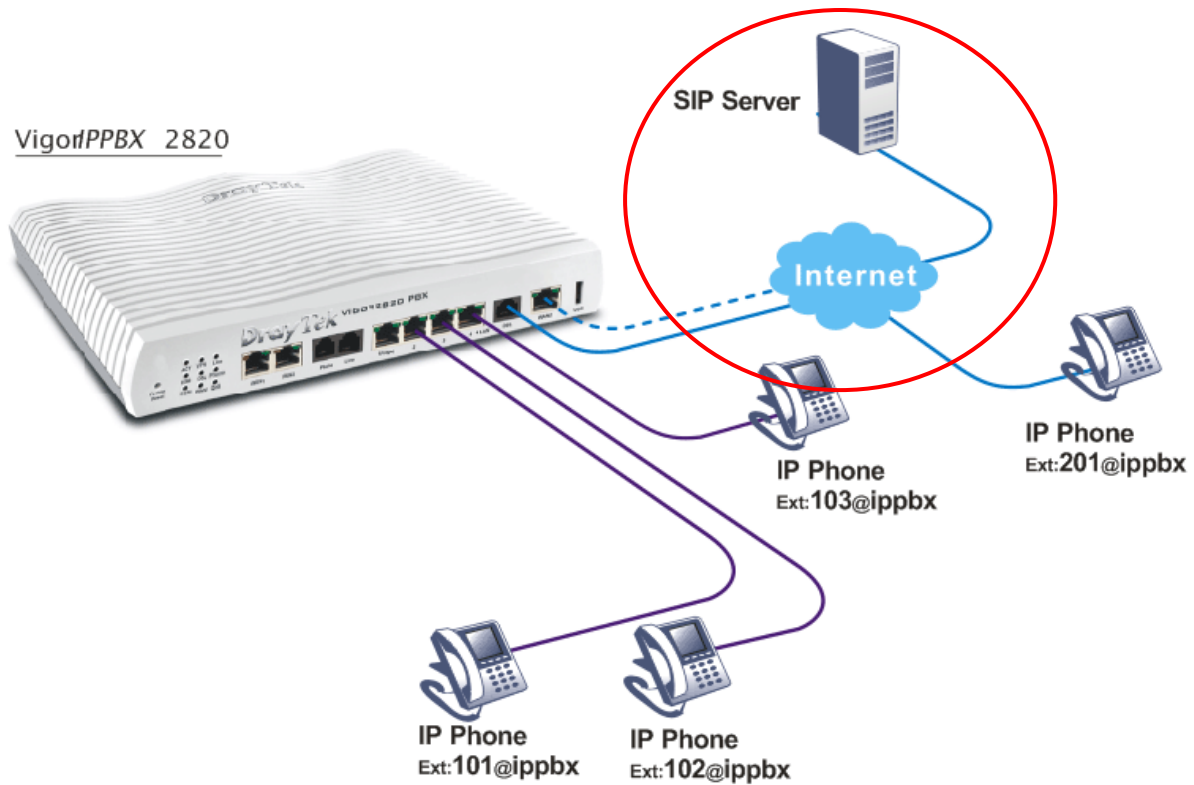

- The establishment through DSL Internet.
- Flexible second WAN for back-up.
- IP-based telephones are connected to LAN ports and set with ext. no. 101, 102 & 103.
- The IP-based telephones (101, 102, and 103) and remote IP-based phone are registered on the VigorIPPBX 2820.
- The IP-based phone with ext. no. 201 is at remote site.
- **The VigorIPPBX 2820 seamlessly integrate with ITSP services (allow you to register at a SIP server).**

3.4 The Integration VoIP Communications via SIP Server

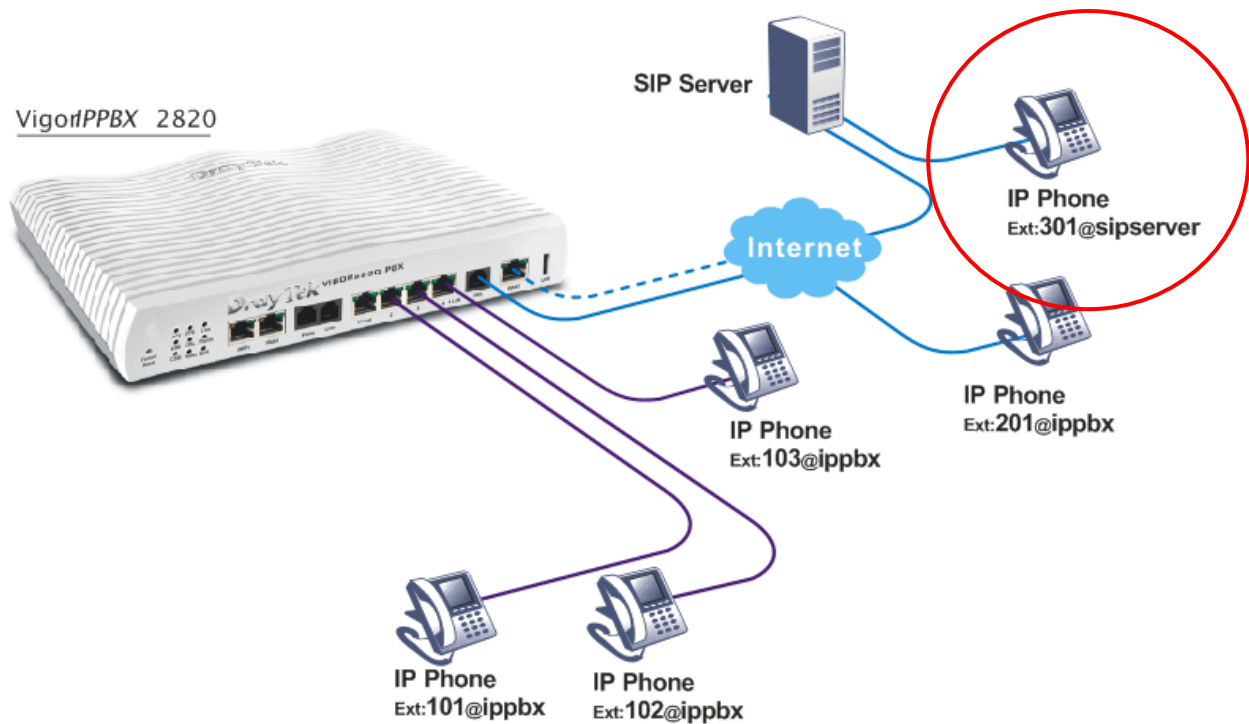

- The establishment through DSL Internet.
- Flexible second WAN for back-up.
- IP-based telephones are connected to LAN ports and set with ext. no. 101, 102 & 103.
- The IP-based telephones (101, 102, and 103) and remote IP-based phone are registered on the VigorIPPBX 2820.
- The IP-based phone with ext. no. 201 is at remote site.
- The VigorIPPBX 2820 seamlessly integrate with ITSP services (allow you to register at a SIP server).
- **The remote IP-based phone with ext. 301 is registered at a SIP server.**

3.5 The Integration with PSTN telephony

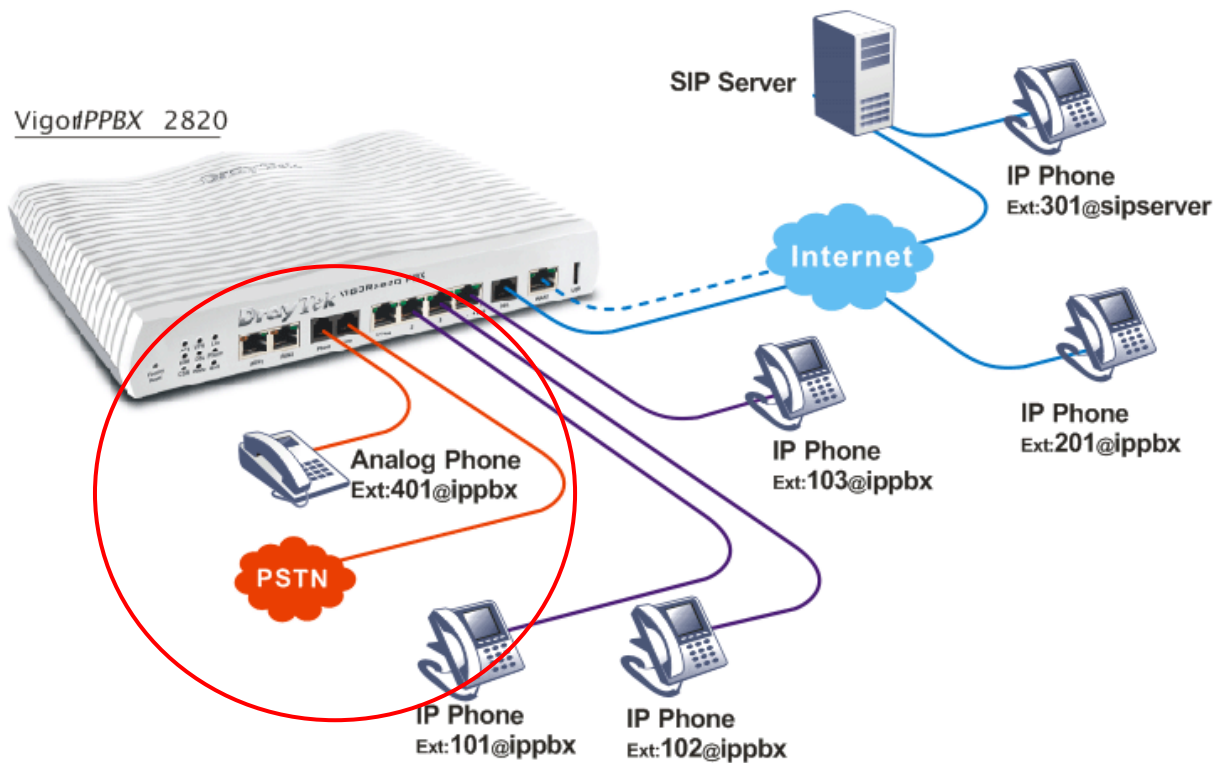

- The establishment through DSL Internet.
- Flexible second WAN for back-up.
- IP-based telephones are connected to LAN ports and set with ext. no. 101, 102 & 103.
- The IP-based telephones (101, 102, and 103) and remote IP-based phone are registered on the VigorIPPBX 2820.
- The IP-based phone with ext. no. 201 is at remote site.
- The VigorIPPBX 2820 seamlessly integrate with ITSP services (allow you to register at a SIP server).
- The remote IP-based phone with ext. 301 is registered at a SIP server.
- **The analog land line is connected to the Line port.**
- **The analog phone is connected to the Phone port and is using ext. no. 401 at the VigorIPPBX 2820.**

3.6 The Added ISDN Telephony

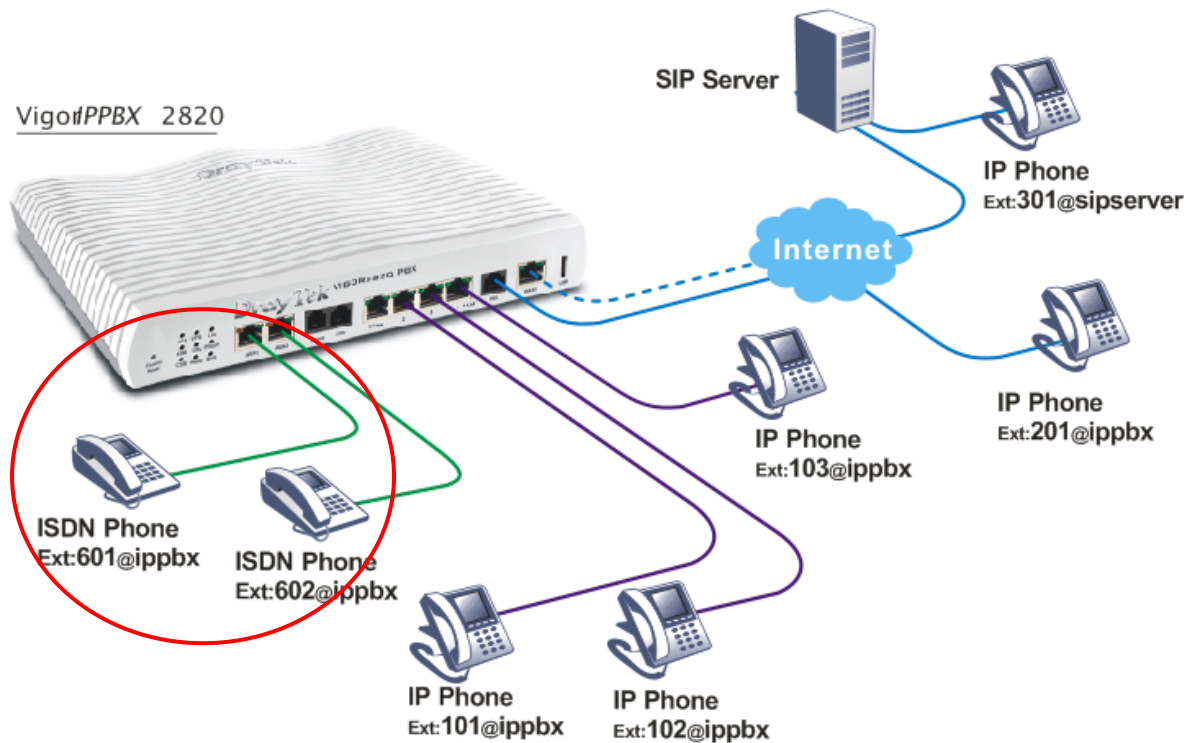

- The establishment through DSL Internet.
- Flexible second WAN for back-up.
- IP-based telephones are connected to LAN ports and set with ext. no. 101, 102 & 103.
- The IP-based telephones (101, 102, and 103) and remote IP-based phone are registered on the VigorIPPBX 2820.
- The IP-based phone with ext. no. 201 is at remote site.
- The VigorIPPBX 2820 seamlessly integrate with ITSP services (allow you to register at a SIP server).
- The remote IP-based phone with ext. 301 is registered at a SIP server.
- **The ISDN phones with ext. no. 601 and 602 are connected to NT-interface of the VigorIPPBX 2820.**

3.7 The Integrated ISDN line

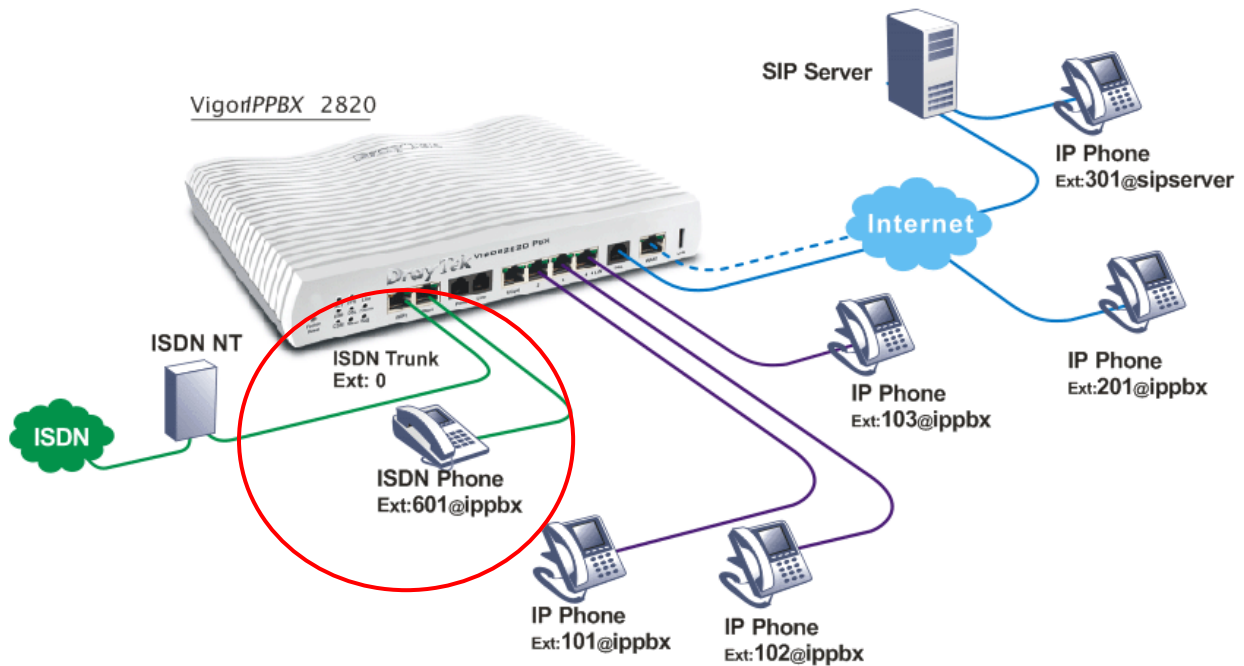

- The establishment through DSL Internet.
- Flexible second WAN for back-up.
- IP-based telephones are connected to LAN ports and set with ext. no. 101, 102 & 103.
- The IP-based telephones (101, 102, and 103) and remote IP-based phone are registered on the VigorIPPBX 2820.
- The IP-based phone with ext. no. 201 is at remote site.
- The VigorIPPBX 2820 seamlessly integrate with ITSP services (allow you to register at a SIP server).
- The remote IP-based phone with ext. 301 is registered at a SIP server.
- **The ISDN line is connected to TE-interface of the VigorIPPBX 2820.**
- **The ISDN phone with ext. no. 601 is connected to NT-interface of the VigorIPPBX 2820.**

3.8 The 4 B Channels of Two ISDN Lines

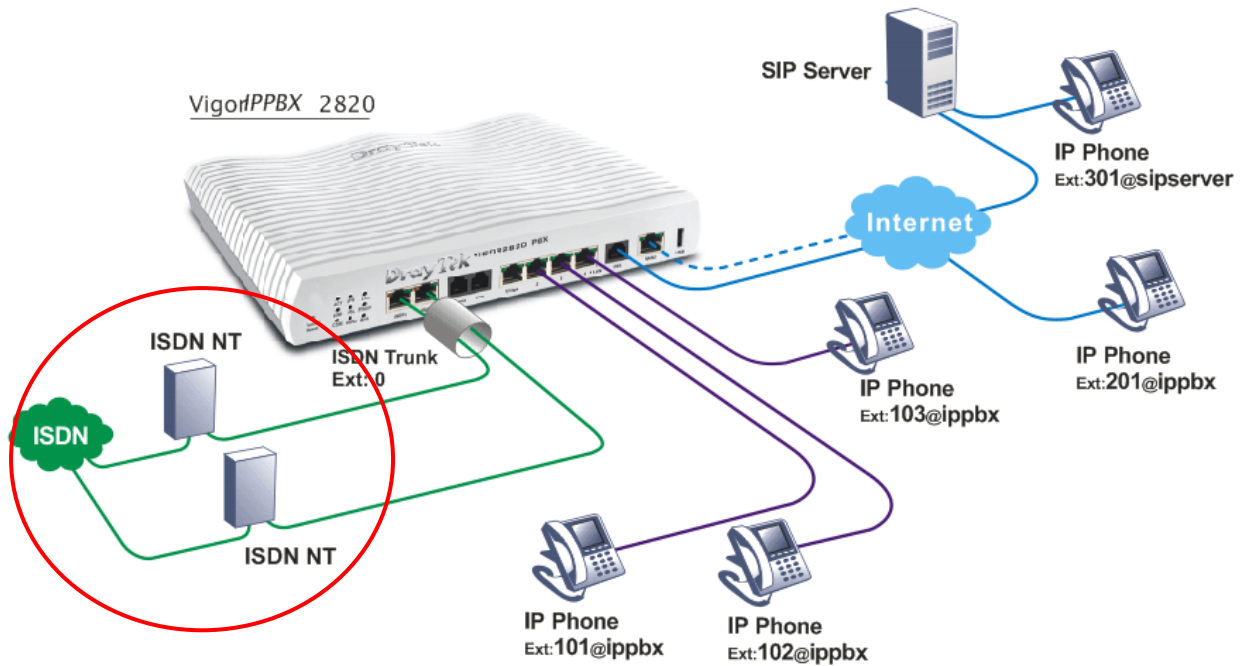

- The establishment through DSL Internet.
- Flexible second WAN for back-up.
- IP-based telephones are connected to LAN ports and set with ext. no. 101, 102 & 103.
- The IP-based telephones (101, 102, and 103) and remote IP-based phone are registered on the VigorIPPBX 2820.
- The IP-based phone with ext. no. 201 is at remote site.
- The VigorIPPBX 2820 seamlessly integrate with ITSP services (allow you to register at a SIP server).
- The remote IP-based phone with ext. 301 is registered at a SIP server.
- **The two ISDN lines are connected to two TE-interfaces of the VigorIPPBX 2820.**

3.9 The Integration of ISDN PBX with One ISDN Line

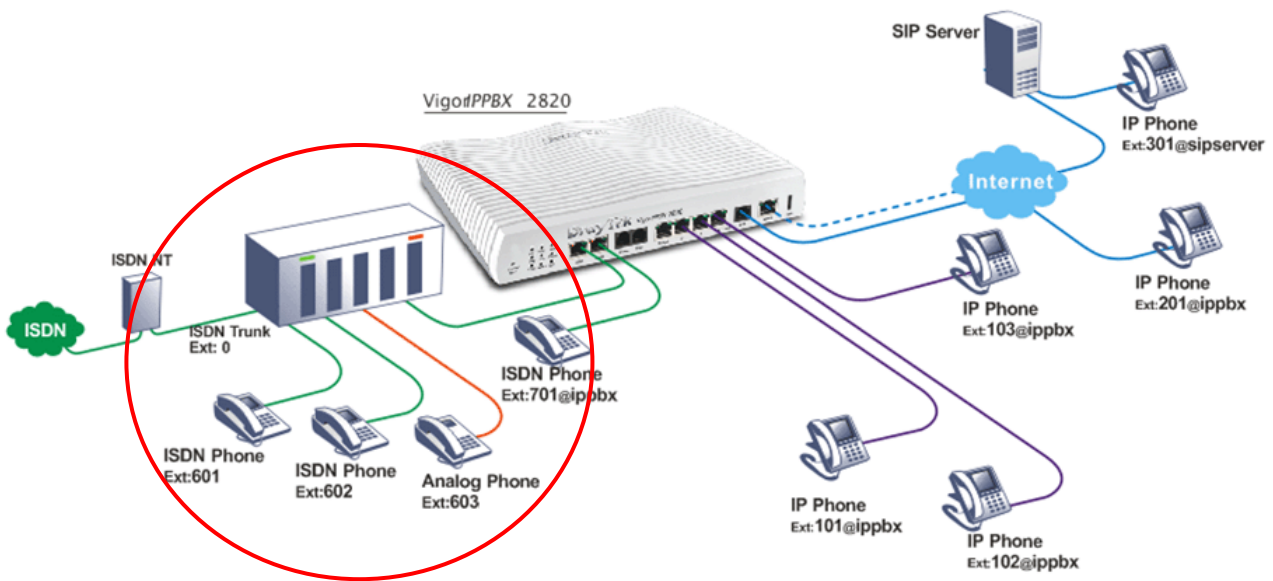

- The establishment through DSL Internet.
- Flexible second WAN for back-up.
- IP-based telephones are connected to LAN ports and set with ext. no. 101, 102 & 103.
- The IP-based telephones (101, 102, and 103) and remote IP-based phone are registered On the VigorIPPBX 2820.
- The IP-based phone with ext. no. 201 is at remote site.
- The VigorIPPBX 2820 seamlessly integrate with ITSP services (allow you to register at a SIP server).
- The remote IP-based phone with ext. 301 is registered at a SIP server.
- **The ISDN phone with ext. no. 701 is connected to NT-interface of the VigorIPPBX 2820.**
- **The ISDN PBX is connected to TE-interface of the VigorIPPBX 2820. The ISDN phones with ext. no. 601 and 602 are connected to ISDN PBX.**
- **The ISDN PBX also provides analog extensions to allow analog phones to be connected. The analog phone with ext. no. 603 is connected at the ISDN PBX.**

3.10 The Integration of ISDN PBX with One ISDN Line-2

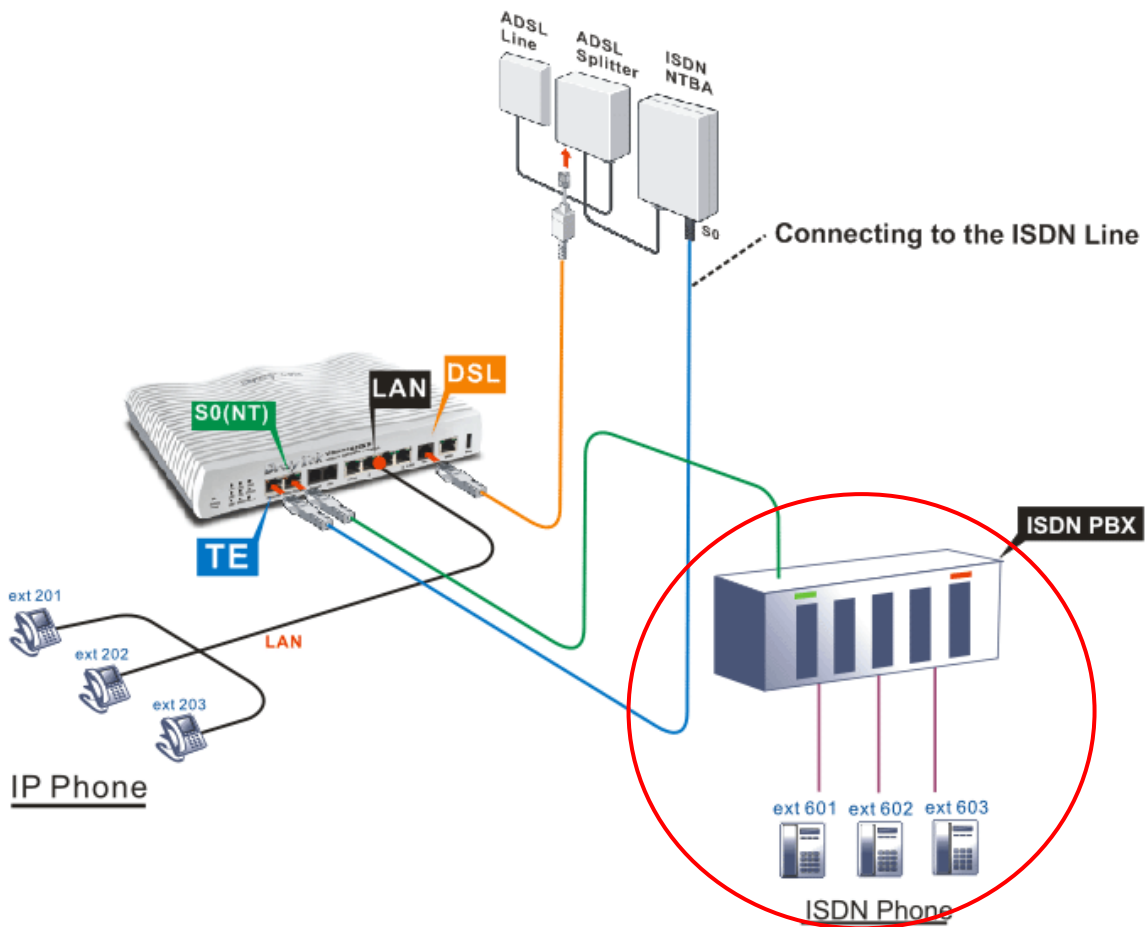

- The establishment through DSL Internet.
- Flexible second WAN for back-up.
- IP-based telephones are connected to LAN ports and set with ext. no. 101, 102 & 103.
- The IP-based telephones (201, 202, and 203) and remote IP-based phone are registered on the VigorIPPBX 2820.
- The VigorIPPBX 2820 seamlessly integrate with ITSP services (allow you to register at a SIP server).
- **The ISDN PBX is connected to S0-interface of the VigorIPPBX 2820. The ISDN phones with ext. no. 601 and 602 are connected to ISDN PBX.**
- **The ISDN line is connected to TE-interface of the VigorIPPBX 2820.**

3.11 The Deployment of ISDN PBX and PSTN Network

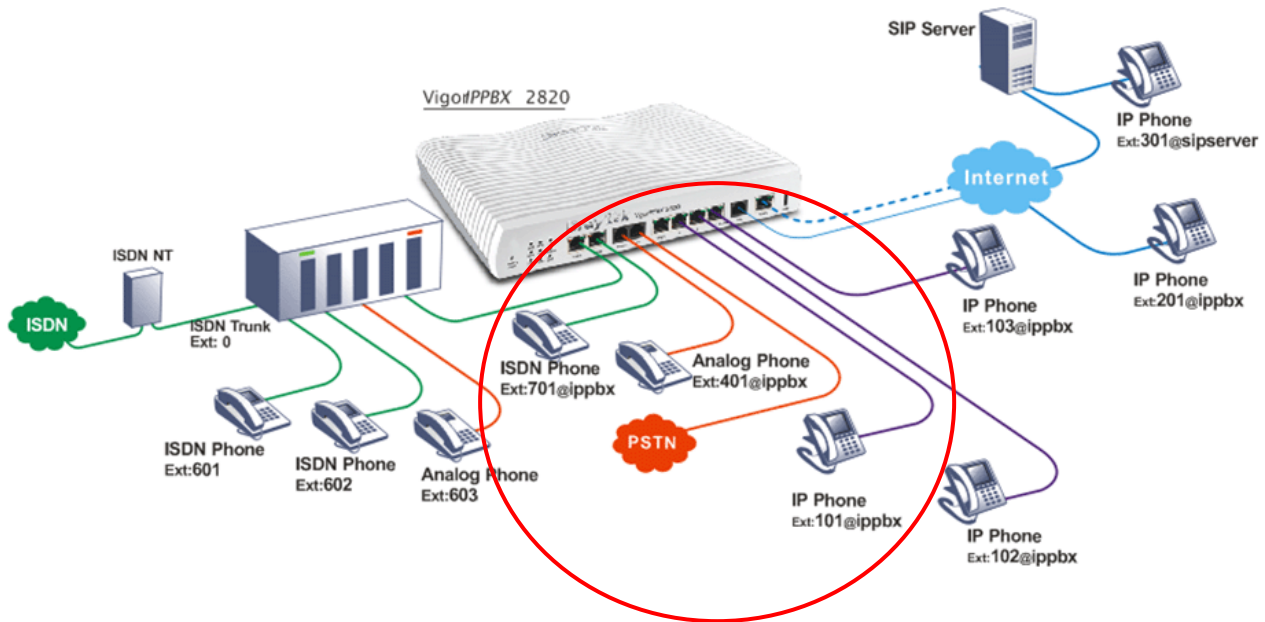

- The establishment through DSL Internet.
- Flexible second WAN for back-up.
- IP-based telephones are connected to LAN ports and set with ext. no. 101, 102 & 103.
- The IP-based telephones (101, 102, and 103) and remote IP-based phone are registered on the VigorIPPBX 2820.
- The IP-based phone with ext. no. 201 is at remote site.
- The VigorIPPBX 2820 seamlessly integrate with ITSP services (allow you to register at a SIP server).
- The remote IP-based phone with ext. 301 is registered at a SIP server.
- The ISDN phone with ext. no. 701 is connected to NT-interface of the VigorIPPBX 2820.
- The ISDN PBX is connected to TE-interface of the VigorIPPBX 2820. The ISDN phones with ext. no. 601 and 602 are connected to ISDN PBX.
- The ISDN PBX also provides analog extensions to allow analog phones to be connected. The analog phone with ext. no. 603 is connected at the ISDN PBX.
- **The analog land line is connected to the Line port.**
- **The analog phone is connected to the Phone port and is using ext. no. 401 at the VigorIPPBX 2820.**

3.12 The Integration of ISDN Telephony and PSTN Network

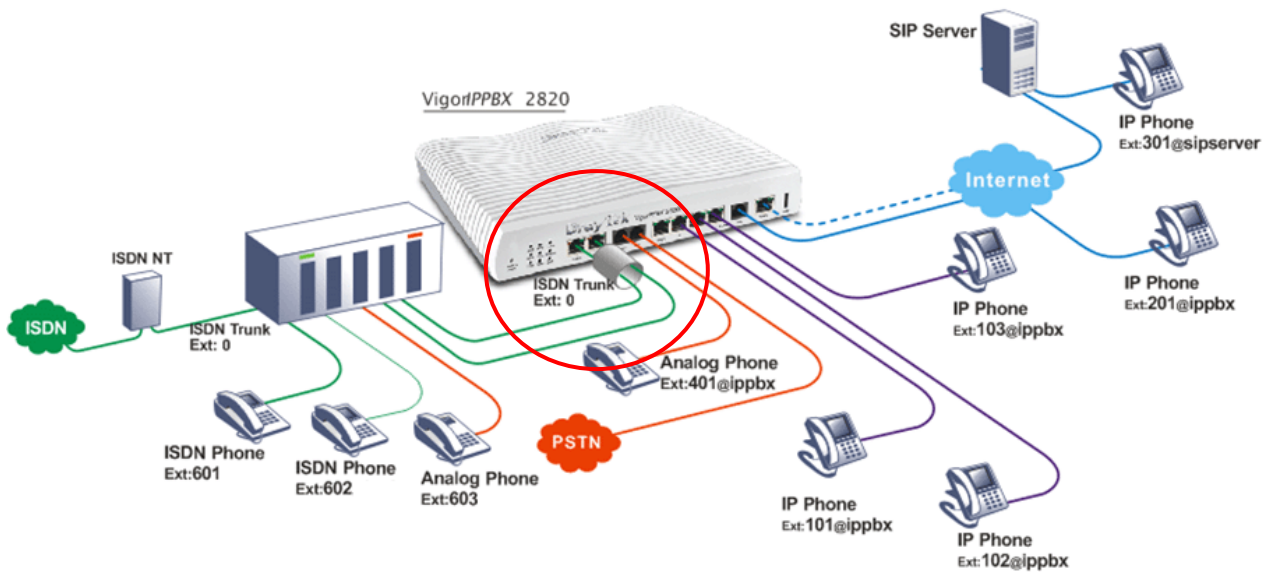

- The establishment through DSL Internet.
- Flexible second WAN for back-up.
- IP-based telephones are connected to LAN ports and set with ext. no. 101, 102 & 103.
- The IP-based telephones (101, 102, and 103) and remote IP-based phone are registered on VigorIPPBX 2820.
- The IP-based phone with ext. no. 201 is at remote site.
- The VigorIPPBX 2820 seamlessly integrate with ITSP services (allow you to register at a SIP server).
- The remote IP-based phone with ext. 301 is registered at a SIP server.
- The ISDN phones with ext. no. 601 and 602 are connected to ISDN PBX.
- The ISDN PBX also provides analog extensions to allow analog phones to be connected. The analog phone with ext. no. 603 is connected at the ISDN PBX.
- The analog land line is connected to the Line port.
- The analog phone is connected to the Phone port and is using ext. no. 401 at VigorIPPBX 2820.
- **The ISDN PBX's two internal lines are connected to the TE-interfaces of the VigorIPPBX 2820.**

3.13 The Integration of ISDN Telephony, PSTN Network and VoIP Connection

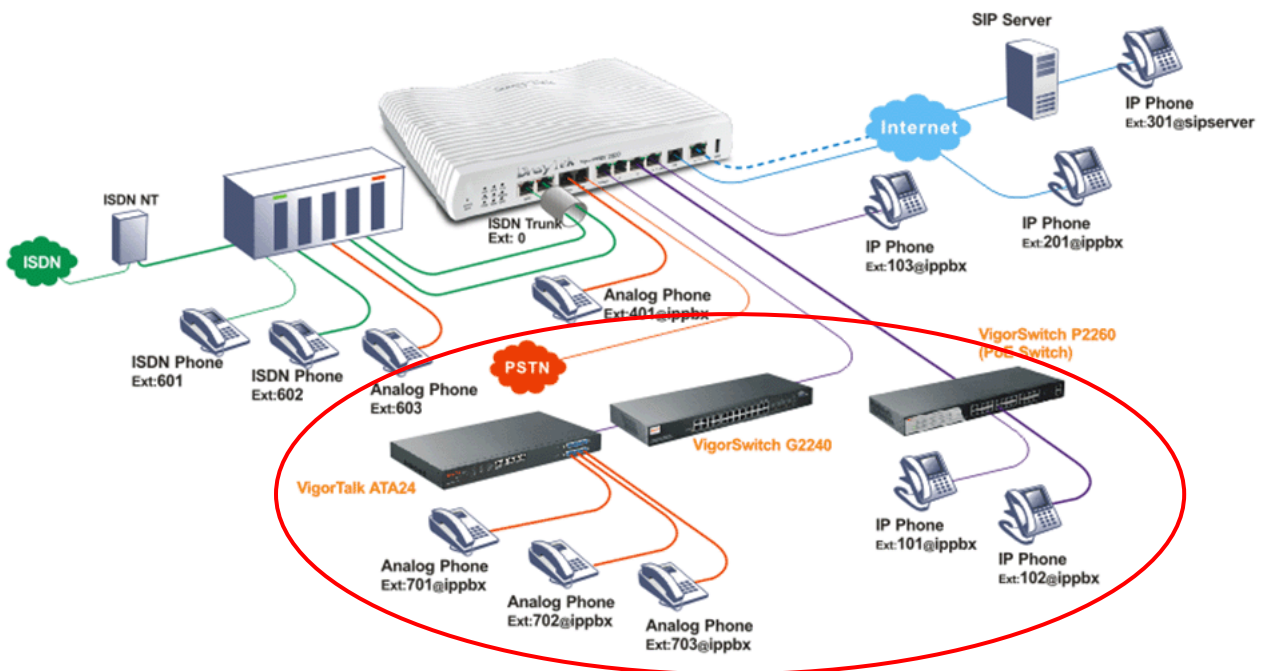

- The establishment through DSL Internet.
- Flexible second WAN for back-up.
- IP-based telephones with ext. no. 101 & 102 are connected to LAN ports of the **VigorSwitch**. **Analog telephones with ext. no. 701, 702 & 703 are connected to the VigorTalk ATA24 and are registered at the VigorIPPBX 2820.**
- The IP-based telephone with ext. no. 103 and remote IP-based phone ext. no. 201 are registered on the VigorIPPBX 2820.
- The IP-based phone with ext. no. 201 is at remote site.
- The VigorIPPBX 2820 seamlessly integrate with ITSP services (allow you to register at a SIP server).
- The remote IP-based phone with ext. 301 is registered at a SIP server.
- The ISDN phones with ext. no. 601 and 602 are connected to ISDN PBX.
- The ISDN PBX also provides analog extensions to allow analog phones to be connected. The analog phone with ext. no. 603 is connected at the ISDN PBX.
- The analog land line is connected to the Line port.
- The analog phone is connected to the Phone port and is using ext. no. 401 at VigorIPPBX 2820.
- The ISDN PBX's two internal lines are connected to the TE-interfaces of the VigorIPPBX 2820.

This page is left blank.

Chapter 4: Tutorial

4.1 Create a LAN-to-LAN Connection Between Remote Office and Headquarter

The most common case is that you may want to connect to network securely, such as the remote branch office and headquarter. According to the network structure as shown in the below illustration, you may follow the steps to create a LAN-to-LAN profile. These two networks (LANs) should NOT have the same network address.

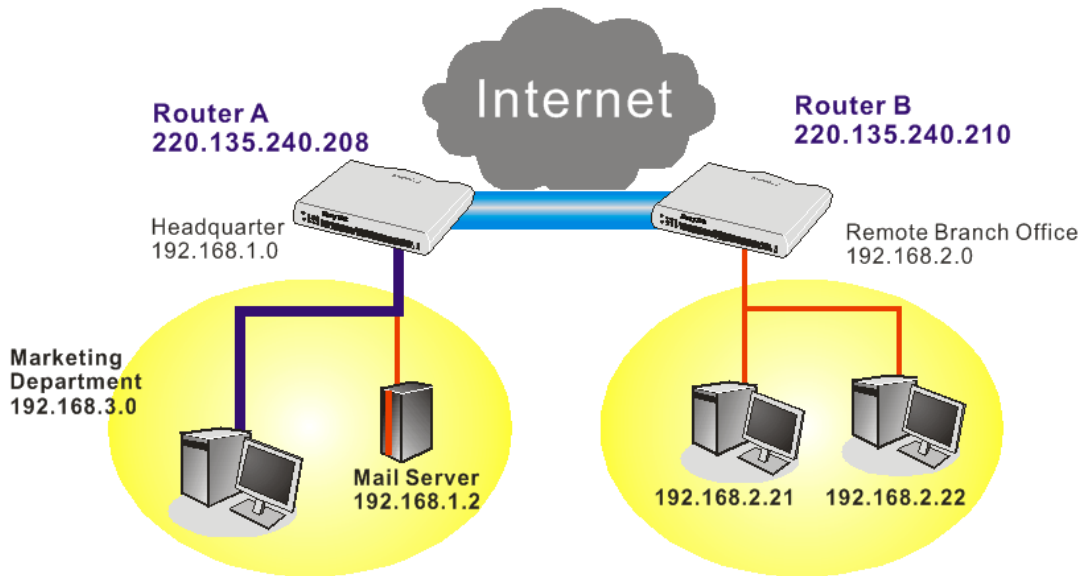

Settings in Router A in headquarter:

1. Go to **VPN and Remote Access** and select **Remote Access Control** to enable the necessary VPN service and click **OK**.
2. Then,

For using **PPP** based services, such as PPTP, L2TP, you have to set general settings in **PPP General Setup**.

VPN and Remote Access >> PPP General Setup

PPP General Setup	
PPP/MP Protocol	
Dial-In PPP Authentication	PAP or CHAP
Dial-In PPP Encryption (MPPE)	Optional MPPE
Mutual Authentication (PAP)	<input type="radio"/> Yes <input checked="" type="radio"/> No
Username	<input type="text"/>
Password	<input type="text"/>
IP Address Assignment for Dial-In Users (When DHCP Disable set)	
Start IP Address	192.168.1.200

OK

For using **IPSec**-based service, such as IPSec or L2TP with IPSec Policy, you have to set general settings in **IPSec General Setup**, such as the pre-shared key that both parties have known.

[VPN and Remote Access >> IPSec General Setup](#)

VPN IKE/IPSec General Setup

Dial-in Set up for Remote Dial-in users and Dynamic IP Client (LAN to LAN).

IKE Authentication Method	
Pre-Shared Key	<input type="password" value="•••••"/>
Confirm Pre-Shared Key	<input type="password" value="•••••"/>
IPSec Security Method	
<input checked="" type="checkbox"/> Medium (AH)	Data will be authentic, but will not be encrypted.
High (ESP) <input checked="" type="checkbox"/> DES <input checked="" type="checkbox"/> 3DES <input checked="" type="checkbox"/> AES	Data will be encrypted and authentic.
<input type="button" value="OK"/> <input type="button" value="Cancel"/>	

- Go to **LAN-to-LAN**. Click on one index number to edit a profile.
- Set **Common Settings** as shown below. You should enable both of VPN connections because any one of the parties may start the VPN connection.

[VPN and Remote Access >> LAN to LAN](#)

Profile Index : 1

1. Common Settings

Profile Name <input type="text" value="Branch1"/>	Call Direction <input checked="" type="radio"/> Both <input type="radio"/> Dial-Out <input type="radio"/> Dial-In
<input type="checkbox"/> Enable this profile	<input type="checkbox"/> Always on
VPN Connection Through: <input type="text" value="WAN1 First"/>	Idle Timeout <input type="text" value="300"/> second(s)
Netbios Naming Packet <input checked="" type="radio"/> Pass <input type="radio"/> Block	<input type="checkbox"/> Enable PING to keep alive
	PING to the IP <input type="text"/>

- Set **Dial-Out Settings** as shown below to dial to connect to Router B aggressively with the selected Dial-Out method.

If an **IPSec-based** service is selected, you should further specify the remote peer IP Address, IKE Authentication Method and IPSec Security Method for this Dial-Out connection.

2. Dial-Out Settings

<p>Type of Server I am calling</p> <p> <input type="radio"/> ISDN <input type="radio"/> PPTP <input checked="" type="radio"/> IPSec Tunnel <input type="radio"/> L2TP with IPSec Policy None </p> <p>Dial Number for ISDN or Server IP/Host Name for VPN. (such as 5551234, draytek.com or 123.45.67.89)</p> <p><input style="width: 150px;" type="text" value="220.135.240.210"/></p>	<p>Link Type 64k bps</p> <p>Username <input data-bbox="1021 448 1173 481" style="width: 80px;" type="text" value="???"/></p> <p>Password <input data-bbox="1021 481 1173 515" style="width: 80px;" type="password"/></p> <p>PPP Authentication PAP/CHAP</p> <p>VJ Compression <input checked="" type="radio"/> On <input type="radio"/> Off</p> <hr/> <p>IKE Authentication Method</p> <p><input checked="" type="radio"/> Pre-Shared Key</p> <p>IKE Pre-Shared Key <input data-bbox="1021 638 1189 672" style="width: 80px;" type="text"/></p> <p><input type="radio"/> Digital Signature(X.509)</p> <p>None</p> <hr/> <p>IPSec Security Method</p> <p><input checked="" type="radio"/> Medium(AH)</p> <p><input type="radio"/> High(ESP) DES without Authentication</p> <p>Advanced</p> <hr/> <p>Index(1-15) in Schedule Setup:</p> <p><input style="width: 30px;" type="text"/> , <input style="width: 30px;" type="text"/> , <input style="width: 30px;" type="text"/> , <input style="width: 30px;" type="text"/></p> <hr/> <p>Callback Function (CBCP)</p> <p><input type="checkbox"/> Require Remote to Callback</p> <p><input type="checkbox"/> Provide ISDN Number to Remote</p>
--	--

If a **PPP-based service** is selected, you should further specify the remote peer IP Address, Username, Password, PPP Authentication and VJ Compression for this Dial-Out connection.

2. Dial-Out Settings

<p>Type of Server I am calling</p> <p> <input type="radio"/> ISDN <input checked="" type="radio"/> PPTP <input type="radio"/> IPSec Tunnel <input type="radio"/> L2TP with IPSec Policy None </p> <p>Dial Number for ISDN or Server IP/Host Name for VPN. (such as 5551234, draytek.com or 123.45.67.89)</p> <p><input style="width: 150px;" type="text" value="220.135.240.210"/></p>	<p>Link Type 64k bps</p> <p>Username <input data-bbox="885 1243 1181 1276" style="width: 80px;" type="text" value="draytek"/></p> <p>Password <input data-bbox="909 1276 1173 1310" style="width: 80px;" type="password" value="*****"/></p> <p>PPP Authentication PAP/CHAP</p> <p>VJ Compression <input checked="" type="radio"/> On <input type="radio"/> Off</p> <hr/> <p>IKE Authentication Method</p> <p><input checked="" type="radio"/> Pre-Shared Key</p> <p>IKE Pre-Shared Key <input data-bbox="1021 1433 1189 1467" style="width: 80px;" type="text"/></p> <p><input type="radio"/> Digital Signature(X.509)</p> <p>None</p> <hr/> <p>IPSec Security Method</p> <p><input checked="" type="radio"/> Medium(AH)</p> <p><input type="radio"/> High(ESP) DES without Authentication</p> <p>Advanced</p> <hr/> <p>Index(1-15) in Schedule Setup:</p> <p><input style="width: 30px;" type="text"/> , <input style="width: 30px;" type="text"/> , <input style="width: 30px;" type="text"/> , <input style="width: 30px;" type="text"/></p> <hr/> <p>Callback Function (CBCP)</p> <p><input type="checkbox"/> Require Remote to Callback</p> <p><input type="checkbox"/> Provide ISDN Number to Remote</p>
--	--

6. Set **Dial-In settings** to as shown below to allow Router B dial-in to build VPN connection.

If an **IPSec-based** service is selected, you may further specify the remote peer IP Address, IKE Authentication Method and IPSec Security Method for this Dial-In connection. Otherwise, it will apply the settings defined in **IPSec General Setup** above.

3. Dial-In Settings

<p>Allowed Dial-In Type</p> <p><input type="checkbox"/> ISDN</p> <p><input type="checkbox"/> PPTP</p> <p><input checked="" type="checkbox"/> IPSec Tunnel</p> <p><input type="checkbox"/> L2TP with IPSec Policy None</p> <p><input checked="" type="checkbox"/> Specify ISDN CLID or Remote VPN Gateway</p> <p>Peer ISDN Number or Peer VPN Server IP</p> <p><input type="text" value="220.135.240.210"/></p> <p>or Peer ID <input type="text"/></p>	<p>Username <input style="width: 100px;" type="text" value="???"/></p> <p>Password <input style="width: 100px;" type="password"/></p> <p>VJ Compression <input checked="" type="radio"/> On <input type="radio"/> Off</p> <hr/> <p>IKE Authentication Method</p> <p><input checked="" type="checkbox"/> Pre-Shared Key</p> <p>IKE Pre-Shared Key <input style="width: 100px;" type="text"/></p> <p><input type="checkbox"/> Digital Signature(X.509)</p> <p>None</p> <hr/> <p>IPSec Security Method</p> <p><input checked="" type="checkbox"/> Medium (AH)</p> <p>High (ESP)</p> <p><input checked="" type="checkbox"/> DES <input checked="" type="checkbox"/> 3DES <input checked="" type="checkbox"/> AES</p> <hr/> <p>Callback Function (CBCP)</p> <p><input type="checkbox"/> Enable Callback Function</p> <p><input type="checkbox"/> Use the Following Number to Callback</p> <p>Callback Number <input style="width: 100px;" type="text"/></p> <p>Callback Budget <input type="text" value="0"/> minute(s)</p>
---	---

If a **PPP-based service** is selected, you should further specify the remote peer IP Address, Username, Password, and VJ Compression for this Dial-In connection.

3. Dial-In Settings

<p>Allowed Dial-In Type</p> <p><input type="checkbox"/> ISDN</p> <p><input checked="" type="checkbox"/> PPTP</p> <p><input type="checkbox"/> IPSec Tunnel</p> <p><input type="checkbox"/> L2TP with IPSec Policy None</p> <p><input checked="" type="checkbox"/> Specify ISDN CLID or Remote VPN Gateway</p> <p>Peer ISDN Number or Peer VPN Server IP</p> <p><input type="text" value="220.135.240.210"/></p> <p>or Peer ID <input type="text"/></p>	<p>Username <input style="width: 100px;" type="text" value="draytek"/></p> <p>Password <input style="width: 100px;" type="password"/></p> <p>VJ Compression <input checked="" type="radio"/> On <input type="radio"/> Off</p> <hr/> <p>IKE Authentication Method</p> <p><input checked="" type="checkbox"/> Pre-Shared Key</p> <p>IKE Pre-Shared Key <input style="width: 100px;" type="text"/></p> <p><input type="checkbox"/> Digital Signature(X.509)</p> <p>None</p> <hr/> <p>IPSec Security Method</p> <p><input checked="" type="checkbox"/> Medium (AH)</p> <p>High (ESP)</p> <p><input checked="" type="checkbox"/> DES <input checked="" type="checkbox"/> 3DES <input checked="" type="checkbox"/> AES</p> <hr/> <p>Callback Function (CBCP)</p> <p><input type="checkbox"/> Enable Callback Function</p> <p><input type="checkbox"/> Use the Following Number to Callback</p> <p>Callback Number <input style="width: 100px;" type="text"/></p> <p>Callback Budget <input type="text" value="0"/> minute(s)</p>
---	---

- At last, set the remote network IP/subnet in **TCP/IP Network Settings** so that Router A can direct the packets destined to the remote network to Router B via the VPN connection.

4. TCP/IP Network Settings

My WAN IP	<input type="text" value="0.0.0.0"/>	RIP Direction	<input type="text" value="Disable"/>
Remote Gateway IP	<input type="text" value="0.0.0.0"/>	From first subnet to remote network, you have to do	
Remote Network IP	<input type="text" value="192.168.2.0"/>	<input type="text" value="Route"/>	
Remote Network Mask	<input type="text" value="255.255.255.0"/>	<input type="checkbox"/> Change default route to this VPN tunnel (Only single WAN supports this)	
<input type="button" value="More"/>			

Settings in Router B in the remote office:

- Go to **VPN and Remote Access** and select **Remote Access Control** to enable the necessary VPN service and click **OK**.
- Then, for using **PPP based** services, such as PPTP, L2TP, you have to set general settings in **PPP General Setup**.

VPN and Remote Access >> PPP General Setup

PPP General Setup	
PPP/MP Protocol	IP Address Assignment for Dial-In Users (When DHCP Disable set)
Dial-In PPP Authentication	<input type="text" value="PAP or CHAP"/>
Dial-In PPP Encryption (MPPE)	<input type="text" value="Optional MPPE"/>
Mutual Authentication (PAP)	<input type="radio"/> Yes <input checked="" type="radio"/> No
Username	<input type="text"/>
Password	<input type="text"/>
	Start IP Address <input type="text" value="192.168.2.200"/>

For using **IPSec-based** service, such as IPSec or L2TP with IPSec Policy, you have to set general settings in **IPSec General Setup**, such as the pre-shared key that both parties have known.

VPN and Remote Access >> IPSec General Setup

VPN IKE/IPSec General Setup	
Dial-in Set up for Remote Dial-in users and Dynamic IP Client (LAN to LAN).	
IKE Authentication Method	
Pre-Shared Key	<input type="text" value="....."/>
Confirm Pre-Shared Key	<input type="text" value="....."/>
IPSec Security Method	
<input checked="" type="checkbox"/> Medium (AH)	Data will be authentic, but will not be encrypted.
High (ESP)	<input checked="" type="checkbox"/> DES <input checked="" type="checkbox"/> 3DES <input checked="" type="checkbox"/> AES
	Data will be encrypted and authentic.

- Go to **LAN-to-LAN**. Click on one index number to edit a profile.

4. Set **Common Settings** as shown below. You should enable both of VPN connections because any one of the parties may start the VPN connection.

VPN and Remote Access >> LAN to LAN

Profile Index : 1

1. Common Settings

Profile Name <input type="text" value="Branch1"/>	Call Direction <input checked="" type="radio"/> Both <input type="radio"/> Dial-Out <input type="radio"/> Dial-In
<input type="checkbox"/> Enable this profile	<input type="checkbox"/> Always on
VPN Connection Through: <input type="text" value="WAN1 First"/>	Idle Timeout <input type="text" value="300"/> second(s)
Netbios Naming Packet <input checked="" type="radio"/> Pass <input type="radio"/> Block	<input type="checkbox"/> Enable PING to keep alive
	PING to the IP <input type="text"/>

5. Set **Dial-Out Settings** as shown below to dial to connect to Router B aggressively with the selected Dial-Out method.

If an **IPSec-based** service is selected, you should further specify the remote peer IP Address, IKE Authentication Method and IPSec Security Method for this Dial-Out connection.

2. Dial-Out Settings

<p>Type of Server I am calling</p> <p><input type="radio"/> ISDN</p> <p><input type="radio"/> PPTP</p> <p><input checked="" type="radio"/> IPSec Tunnel</p> <p><input type="radio"/> L2TP with IPSec Policy <input type="text" value="None"/></p> <p>Dial Number for ISDN or Server IP/Host Name for VPN. (such as 5551234, draytek.com or 123.45.67.89)</p> <p><input type="text" value="220.135.240.208"/></p>	<p>Link Type <input type="text" value="64k bps"/></p> <p>Username <input type="text" value="draytek"/></p> <p>Password <input type="text"/></p> <p>PPP Authentication <input type="text" value="PAP/CHAP"/></p> <p>VJ Compression <input checked="" type="radio"/> On <input type="radio"/> Off</p> <p>IKE Authentication Method</p> <p><input checked="" type="radio"/> Pre-Shared Key</p> <p><input type="text" value=""/></p> <p><input type="radio"/> Digital Signature(X.509)</p> <p><input type="text" value="None"/></p> <p>IPSec Security Method</p> <p><input checked="" type="radio"/> Medium(AH)</p> <p><input type="radio"/> High(ESP) <input type="text" value="DES without Authentication"/></p> <p><input type="button" value="Advanced"/></p> <p>Index(1-15) in Schedule Setup:</p> <p><input type="text"/> , <input type="text"/> , <input type="text"/> , <input type="text"/></p> <p>Callback Function (CBCP)</p> <p><input type="checkbox"/> Require Remote to Callback</p> <p><input type="checkbox"/> Provide ISDN Number to Remote</p>
---	--

If a **PPP-based** service is selected, you should further specify the remote peer IP Address, Username, Password, PPP Authentication and VJ Compression for this Dial-Out connection.

2. Dial-Out Settings

<p>Type of Server I am calling</p> <p><input type="radio"/> ISDN <input checked="" type="radio"/> PPTP <input type="radio"/> IPsec Tunnel <input type="radio"/> L2TP with IPsec Policy None</p> <p>Dial Number for ISDN or Server IP/Host Name for VPN. (such as 5551234, draytek.com or 123.45.67.89) <input type="text" value="220.135.240.208"/></p>	<p>Link Type 64k bps</p> <p>Username <input type="text" value="draytek"/></p> <p>Password <input type="password" value="*****"/></p> <p>PPP Authentication PAP/CHAP</p> <p>VJ Compression <input checked="" type="radio"/> On <input type="radio"/> Off</p> <p>IKE Authentication Method</p> <p><input checked="" type="radio"/> Pre-Shared Key <input type="text" value="IKE Pre-Shared Key"/></p> <p><input type="radio"/> Digital Signature(X.509) None</p> <p>IPsec Security Method</p> <p><input checked="" type="radio"/> Medium(AH) <input type="radio"/> High(ESP) DES without Authentication</p> <p><input type="button" value="Advanced"/></p> <p>Index:(1-15) in Schedule Setup: <input type="text"/> , <input type="text"/> , <input type="text"/> , <input type="text"/></p> <p>Callback Function (CBCP)</p> <p><input type="checkbox"/> Require Remote to Callback <input type="checkbox"/> Provide ISDN Number to Remote</p>
--	---

- Set **Dial-In settings** to as shown below to allow Router A dial-in to build VPN connection.

If an **IPSec-based** service is selected, you may further specify the remote peer IP Address, IKE Authentication Method and IPsec Security Method for this Dial-In connection. Otherwise, it will apply the settings defined in **IPsec General Setup** above.

3. Dial-In Settings

<p>Allowed Dial-In Type</p> <p><input type="checkbox"/> ISDN <input type="checkbox"/> PPTP <input checked="" type="checkbox"/> IPsec Tunnel <input type="checkbox"/> L2TP with IPsec Policy None</p> <p><input checked="" type="checkbox"/> Specify ISDN CLID or Remote VPN Gateway Peer ISDN Number or Peer VPN Server IP <input type="text" value="220.135.240.208"/> or Peer ID <input type="text"/></p>	<p>Username <input type="text" value="draytek"/></p> <p>Password <input type="password"/></p> <p>VJ Compression <input checked="" type="radio"/> On <input type="radio"/> Off</p> <p>IKE Authentication Method</p> <p><input checked="" type="checkbox"/> Pre-Shared Key <input type="text" value="IKE Pre-Shared Key"/></p> <p><input type="checkbox"/> Digital Signature(X.509) None</p> <p>IPsec Security Method</p> <p><input checked="" type="checkbox"/> Medium (AH) High (ESP) <input checked="" type="checkbox"/> DES <input checked="" type="checkbox"/> 3DES <input checked="" type="checkbox"/> AES</p> <p>Callback Function (CBCP)</p> <p><input type="checkbox"/> Enable Callback Function <input type="checkbox"/> Use the Following Number to Callback Callback Number <input type="text"/> Callback Budget <input type="text"/> minute(s)</p>
---	--

If a **PPP-based** service is selected, you should further specify the remote peer IP Address, Username, Password, and VJ Compression for this Dial-In connection.

3. Dial-In Settings

Allowed Dial-In Type	
<input type="checkbox"/> ISDN	
<input checked="" type="checkbox"/> PPTP	
<input type="checkbox"/> IPsec Tunnel	
<input type="checkbox"/> L2TP with IPsec Policy	None
<input checked="" type="checkbox"/> Specify ISDN CLID or Remote VPN Gateway	
Peer ISDN Number or Peer VPN Server IP	
220.135.240.208	
or Peer ID	
Username	
draytek	
Password	
••••••••	
VJ Compression	
<input checked="" type="radio"/> On <input type="radio"/> Off	
IKE Authentication Method	
<input checked="" type="checkbox"/> Pre-Shared Key	
IKE Pre-Shared Key	
<input type="checkbox"/> Digital Signature(X.509)	
None	
IPsec Security Method	
<input checked="" type="checkbox"/> Medium (AH)	
High (ESP)	
<input checked="" type="checkbox"/> DES <input checked="" type="checkbox"/> 3DES <input checked="" type="checkbox"/> AES	
Callback Function (CBCP)	
<input type="checkbox"/> Enable Callback Function	
<input type="checkbox"/> Use the Following Number to Callback	
Callback Number	
Callback Budget	
0 minute(s)	

- At last, set the remote network IP/subnet in **TCP/IP Network Settings** so that Router B can direct the packets destined to the remote network to Router A via the VPN connection.

4. TCP/IP Network Settings

My WAN IP	0.0.0.0	RIP Direction	Disable
Remote Gateway IP	0.0.0.0	From first subnet to remote network, you have to do	
Remote Network IP	192.168.1.0	Route	
Remote Network Mask	255.255.255.0	<input type="checkbox"/> Change default route to this VPN tunnel (Only single WAN supports this)	
<input type="button" value="More"/>			

4.2 Create a Remote Dial-in User Connection Between the Teleworker and Headquarter

The other common case is that you, as a teleworker, may want to connect to the enterprise network securely. According to the network structure as shown in the below illustration, you may follow the steps to create a Remote User Profile and install Smart VPN Client on the remote host.

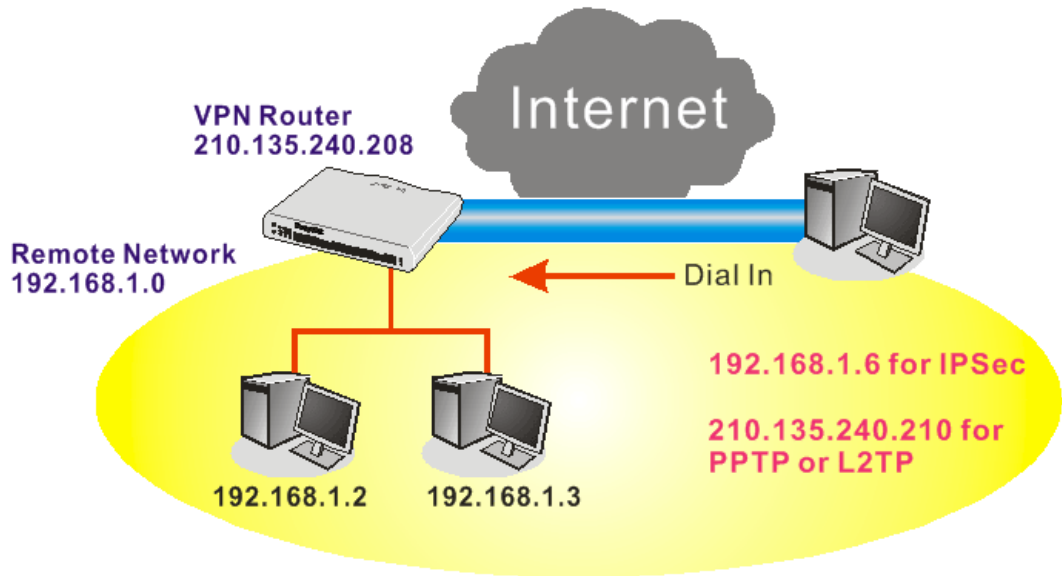

Settings in VPN Router in the enterprise office:

1. Go to **VPN and Remote Access** and select **Remote Access Control** to enable the necessary VPN service and click **OK**.
2. Then, for using PPP based services, such as PPTP, L2TP, you have to set general settings in **PPP General Setup**.

VPN and Remote Access >> PPP General Setup

PPP General Setup	
PPP/MP Protocol	
Dial-In PPP Authentication	PAP or CHAP
Dial-In PPP Encryption (MPPE)	Optional MPPE
Mutual Authentication (PAP)	<input type="radio"/> Yes <input checked="" type="radio"/> No
Username	<input type="text"/>
Password	<input type="text"/>
IP Address Assignment for Dial-In Users (When DHCP Disable set)	
Start IP Address	192.168.1.200

For using IPsec-based service, such as IPsec or L2TP with IPsec Policy, you have to set general settings in **IKE/IPsec General Setup**, such as the pre-shared key that both parties have known.

VPN and Remote Access >> IPSec General Setup

VPN IKE/IPSec General Setup

Dial-in Set up for Remote Dial-in users and Dynamic IP Client (LAN to LAN).

IKE Authentication Method	
Pre-Shared Key
Confirm Pre-Shared Key
IPSec Security Method	
<input checked="" type="checkbox"/> Medium (AH)	Data will be authentic, but will not be encrypted.
High (ESP)	<input checked="" type="checkbox"/> DES <input checked="" type="checkbox"/> 3DES <input checked="" type="checkbox"/> AES
Data will be encrypted and authentic.	

3. Go to **Remote Dial-In User**. Click on one index number to edit a profile.
4. Set **Dial-In** settings to as shown below to allow the remote user dial-in to build VPN connection.

If an **IPSec-based** service is selected, you may further specify the remote peer IP Address, IKE Authentication Method and IPSec Security Method for this Dial-In connection. Otherwise, it will apply the settings defined in **IPSec General Setup** above.

VPN and Remote Access >> Remote Dial-in User

Index No. 1

User account and Authentication	Username <input data-bbox="1134 1126 1337 1155" type="text" value="???"/>
<input type="checkbox"/> Enable this account	Password <input data-bbox="1134 1167 1326 1196" type="text"/>
Idle Timeout <input data-bbox="644 1167 715 1196" type="text" value="300"/> second(s)	
Allowed Dial-In Type	
<input type="checkbox"/> ISDN	
<input type="checkbox"/> PPTP	
<input checked="" type="checkbox"/> IPSec Tunnel	
<input type="checkbox"/> L2TP with IPSec Policy <input data-bbox="667 1357 799 1386" type="text" value="None"/>	
<input checked="" type="checkbox"/> Specify Remote Node	
Remote Client IP or Peer ISDN Number <input data-bbox="464 1458 667 1487" type="text" value="220.135.240.210"/>	
or Peer ID <input data-bbox="557 1498 759 1527" type="text"/>	
	IKE Authentication Method
	<input checked="" type="checkbox"/> Pre-Shared Key
	<input data-bbox="895 1290 1334 1319" type="text" value="IKE Pre-Shared Key"/>
	<input type="checkbox"/> Digital Signature (X.509)
	<input data-bbox="895 1357 965 1386" type="text" value="None"/>
	IPSec Security Method
	<input checked="" type="checkbox"/> Medium (AH)
	High (ESP)
	<input checked="" type="checkbox"/> DES <input checked="" type="checkbox"/> 3DES <input checked="" type="checkbox"/> AES
	Local ID <input data-bbox="983 1543 1185 1572" type="text"/> (optional)
	Callback Function
	<input type="checkbox"/> Check to enable Callback function
	<input type="checkbox"/> Specify the callback number
	Callback Number <input data-bbox="1134 1693 1337 1722" type="text"/>
	<input checked="" type="checkbox"/> Check to enable Callback Budget Control
	Callback Budget <input data-bbox="1134 1767 1204 1796" type="text" value="30"/> minute(s)

If a **PPP-based** service is selected, you should further specify the remote peer IP Address, Username, Password, and VJ Compression for this Dial-In connection.

VPN and Remote Access >> Remote Dial-in User

Index No. 1

<p>User account and Authentication</p> <p><input checked="" type="checkbox"/> Enable this account</p> <p>Idle Timeout <input type="text" value="300"/> second(s)</p>		<p>Username <input type="text" value="draytek"/></p> <p>Password <input type="password" value="••••••"/></p>
<p>Allowed Dial-In Type</p> <p><input type="checkbox"/> ISDN</p> <p><input checked="" type="checkbox"/> PPTP</p> <p><input type="checkbox"/> IPsec Tunnel</p> <p><input type="checkbox"/> L2TP with IPsec Policy <input type="text" value="None"/></p> <p><input checked="" type="checkbox"/> Specify Remote Node</p> <p>Remote Client IP or Peer ISDN Number <input type="text" value="220.135.240.210"/></p> <p>or Peer ID <input type="text"/></p>		<p>IKE Authentication Method</p> <p><input checked="" type="checkbox"/> Pre-Shared Key</p> <p>IKE Pre-Shared Key <input type="text"/></p> <p><input type="checkbox"/> Digital Signature (X.509)</p> <p><input type="text" value="None"/></p>
		<p>IPsec Security Method</p> <p><input checked="" type="checkbox"/> Medium (AH)</p> <p>High (ESP)</p> <p><input checked="" type="checkbox"/> DES <input checked="" type="checkbox"/> 3DES <input checked="" type="checkbox"/> AES</p> <p>Local ID <input type="text"/> (optional)</p>
		<p>Callback Function</p> <p><input type="checkbox"/> Check to enable Callback function</p> <p><input type="checkbox"/> Specify the callback number</p> <p>Callback Number <input type="text"/></p> <p><input checked="" type="checkbox"/> Check to enable Callback Budget Control</p> <p>Callback Budget <input type="text" value="30"/> minute(s)</p>

Settings in the remote host:

- For Win98/ME, you may use "Dial-up Networking" to create the PPTP tunnel to Vigor router. For Win2000/XP, please use "Network and Dial-up connections" or "Smart VPN Client", complimentary software to help you create PPTP, L2TP, and L2TP over IPsec tunnel. You can find it in CD-ROM in the package or go to www.draytek.com download center. Install as instructed.
- After successful installation, for the first time user, you should click on the **Step 0. Configure** button. Reboot the host.

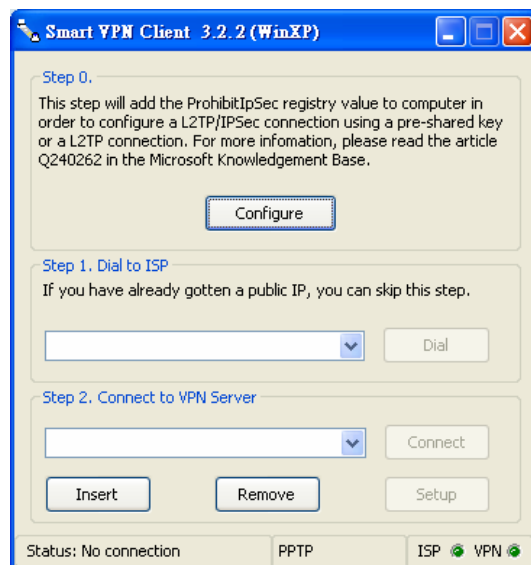

3. In **Step 2. Connect to VPN Server**, click **Insert** button to add a new entry.

If an IPSec-based service is selected as shown below,



You may further specify the method you use to get IP, the security method, and authentication method. If the Pre-Shared Key is selected, it should be consistent with the one set in VPN router.

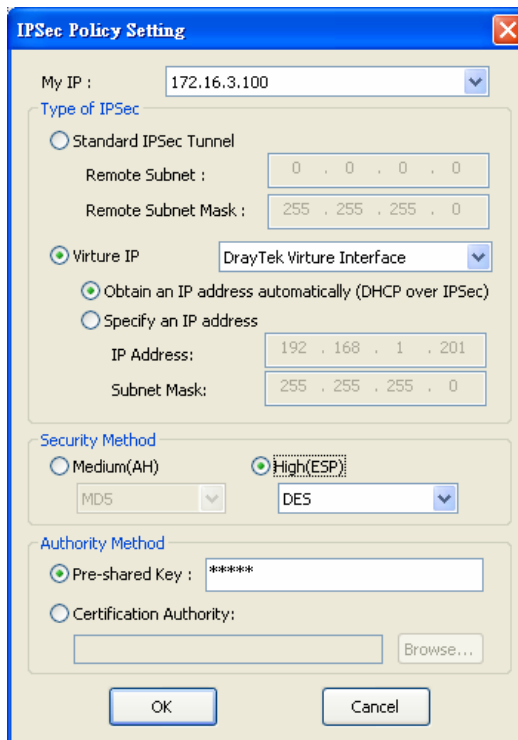

If a PPP-based service is selected, you should further specify the remote VPN server IP address, Username, Password, and encryption method. The User Name and Password should be consistent with the one set up in the VPN router. To use default gateway on remote network means that all the packets of remote host will be directed to VPN server then forwarded to Internet. This will make the remote host seem to be working in the enterprise network.

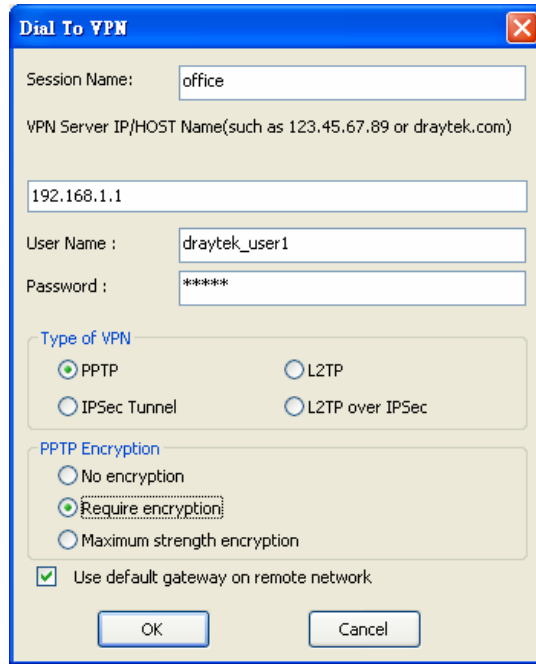

4. Click **Connect** button to build connection. When the connection is successful, you will find a green light on the right down corner.

4.3 QoS Setting Example

Assume a teleworker sometimes works at home and takes care of children. When working time, he would use Vigor router at home to connect to the server in the headquarter office downtown via either HTTPS or VPN to check email and access internal database. Meanwhile, children may chat on Skype in the restroom.

1. Go to **Bandwidth Management>>Quality of Service**.

Bandwidth Management >> Quality of Service

General Setup									Set to Factory Default
Index	Status	Bandwidth	Direction	Class 1	Class 2	Class 3	Others	UDP Bandwidth Control	
WAN1	Enable	10000Kbps/10000Kbps	Outbound	25%	25%	25%	25%	Inactive	Setup
WAN2	Enable	10000Kbps/10000Kbps	Outbound	25%	25%	25%	25%	Inactive	Setup

Class Rule			
Index	Name	Rule	Service Type
Class 1		Edit	
Class 2		Edit	Edit
Class 3		Edit	

2. Click **Setup** link of WAN 1. Make sure the QoS Control on the left corner is checked. And select **BOTH** in **Direction**.

Bandwidth Management >> Quality of Service

WAN1 General Setup

Enable the QoS Control OUT ▾

Index	Class Name
Class 1	
Class 2	

IN

OUT

BOTH

- Return to previous page. Enter the Name of Index Class 1 by clicking **Edit** link. Type the name **E-mail** for Class 1.

Bandwidth Management >> Quality of Service

Class Index # 1

Name

NO	Status	Local Address	Remote Address	DiffServ CodePoint	Service Type
1	Empty	-	-	-	-

- For this index, the user will set reserved bandwidth (e.g., 25%) for **E-mail** using protocol POP3 and SMTP.

Bandwidth Management >> Quality of Service

WAN1 General Setup

Enable the QoS Control BOTH ▾

Index	Class Name	Reserved_bandwidth Ratio
Class 1	E-mail	<input type="text" value="25"/> %
Class 2		<input type="text" value="25"/> %
Class 3		<input type="text" value="25"/> %
	Others	<input type="text" value="25"/> %

Enable UDP Bandwidth Control Limited_bandwidth Ratio %

Outbound TCP ACK Prioritize [Online Statistics](#)

- Return to previous page. Enter the Name of Index Class 2 by clicking **Edit** link. In this index, the user will set reserved bandwidth for **HTTPS**. And click **OK**.

[Bandwidth Management >> Quality of Service](#)

Class Index #2
Name:

NO	Status	Local Address	Remote Address	DiffServ CodePoint	Service Type
1	<input type="radio"/>	Active	Any	Any	ANY

- Click **Setup** link for WAN1.

[Bandwidth Management >> Quality of Service](#)

General Setup | [Set to Factory Default](#)

Index	Status	Bandwidth	Direction	Class 1	Class 2	Class 3	Others	UDP Bandwidth Control	
WAN1	Enable	10000Kbps/10000Kbps	Both	25%	25%	25%	25%	Inactive	Setup
WAN2	Enable	10000Kbps/10000Kbps	Outbound	25%	25%	25%	25%	Inactive	Setup

Class Rule

Index	Name	Rule	Service Type
Class 1	E-mail	Edit	Edit
Class 2	HTTPS	Edit	
Class 3		Edit	

- Check **Enable UDP Bandwidth Control** on the bottom to prevent enormous UDP traffic of VoIP influent other application. Click **OK**.

[Bandwidth Management >> Quality of Service](#)

WAN1 General Setup

Enable the QoS Control

Index	Class Name	Reserved_bandwidth Ratio
Class 1	E-mail	<input type="text" value="25"/> %
Class 2	HTTPS	<input type="text" value="25"/> %
Class 3		<input type="text" value="25"/> %
	Others	<input type="text" value="25"/> %

Enable UDP Bandwidth Control
Limited_bandwidth Ratio %

Outbound TCP ACK Prioritize
 [Online Statistics](#)

- If the worker has connected to the headquarter using host to host VPN tunnel, he may set up an index for it. Enter the Class Name of Index 3. In this index, he will set reserved bandwidth for 1 VPN tunnel.

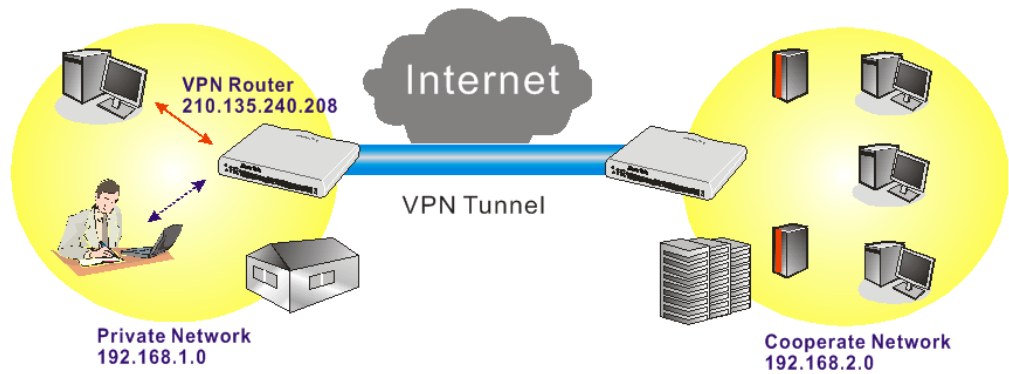

Bandwidth Management >> Quality of Service

Class Index #3

Name

NO	Status	Local Address	Remote Address	DiffServ CodePoint	Service Type
1 <input type="radio"/>	Inactive	Any	Any	ANY	undefined

- Click **Edit** to open the following window. Check the **ACT** box, first.

Bandwidth Management >> Quality of Service

Rule Edit

ACT

Local Address

Remote Address

DiffServ CodePoint

Service Type

Note: Please choose/setup the Service Type first.

10. Then click **Edit** of **Local Address** to set a worker's subnet address. Click **Edit** of **Remote Address** to set headquarter's IP address. Leave other fields and click **OK**.

[Bandwidth Management >> Quality of Service](#)

Rule Edit

<input checked="" type="checkbox"/> ACT		
Local Address	<input type="text" value="192.168.1.10"/>	<input type="button" value="Edit"/>
Remote Address	<input type="text" value="192.168.2.0"/>	<input type="button" value="Edit"/>
DiffServ CodePoint	<input type="text" value="ANY"/>	<input type="button" value="v"/>
Service Type	<input type="text" value="ANY"/>	<input type="button" value="v"/>

Note: Please choose/setup the [Service Type](#) first.

4.4 LAN – Created by Using NAT

An example of default setting and the corresponding deployment are shown below. The default Vigor router private IP address/Subnet Mask is 192.168.1.1/255.255.255.0. The built-in DHCP server is enabled so it assigns every local NATed host an IP address of 192.168.1.x starting from 192.168.1.10.

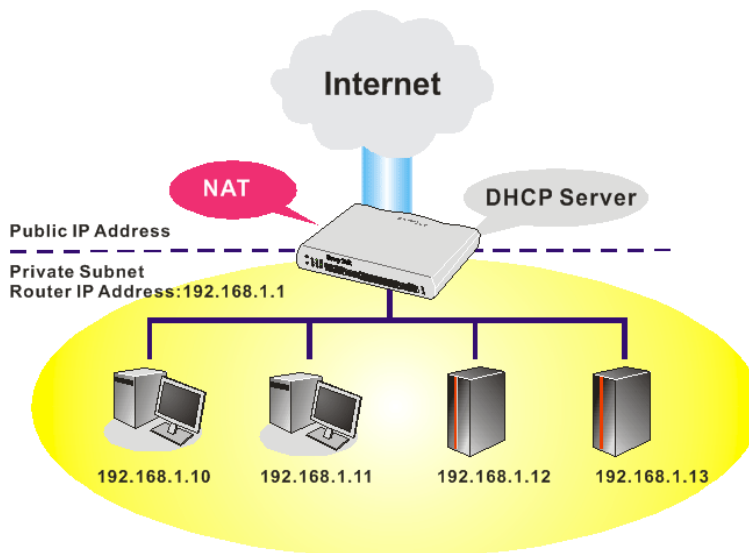

You can just set the settings wrapped inside the red rectangles to fit the request of NAT usage.

LAN >> General Setup

Ethernet TCP / IP and DHCP Setup	
LAN IP Network Configuration For NAT Usage 1st IP Address: 192.168.1.1 1st Subnet Mask: 255.255.255.0 For IP Routing Usage: <input type="radio"/> Enable <input checked="" type="radio"/> Disable 2nd IP Address: 192.168.2.1 2nd Subnet Mask: 255.255.255.0 2nd Subnet DHCP Server: <input type="button" value="2nd Subnet DHCP Server"/> RIP Protocol Control: Disable	DHCP Server Configuration <input checked="" type="radio"/> Enable Server <input type="radio"/> Disable Server Relay Agent: <input type="radio"/> 1st Subnet <input type="radio"/> 2nd Subnet Start IP Address: 192.168.1.10 IP Pool Counts: 50 Gateway IP Address: 192.168.1.1 DHCP Server IP Address for Relay Agent: <input type="text"/> DNS Server IP Address <input type="checkbox"/> Force DNS manual setting Primary IP Address: <input type="text"/> Secondary IP Address: <input type="text"/>

To use another DHCP server in the network rather than the built-in one of Vigor Router, you have to change the settings as show below.

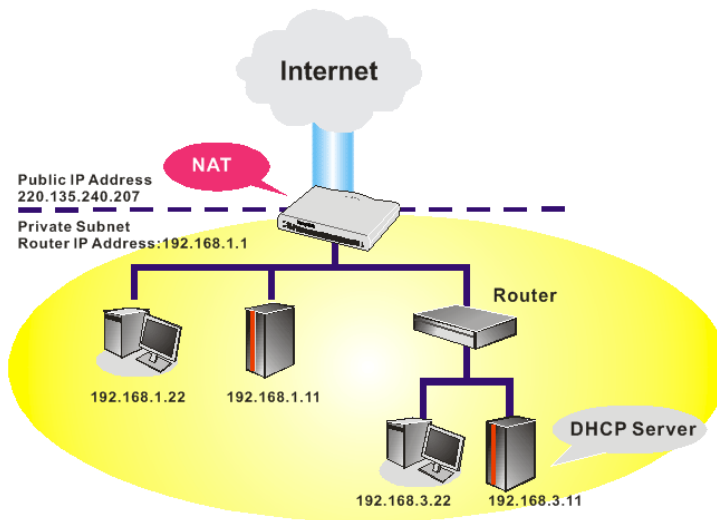

You can just set the settings wrapped inside the red rectangles to fit the request of NAT usage.

LAN >> General Setup

Ethernet TCP / IP and DHCP Setup	
LAN IP Network Configuration For NAT Usage 1st IP Address: 192.168.1.1 1st Subnet Mask: 255.255.255.0 For IP Routing Usage: <input type="radio"/> Enable <input checked="" type="radio"/> Disable 2nd IP Address: 192.168.2.1 2nd Subnet Mask: 255.255.255.0 2nd Subnet DHCP Server: <input type="button" value="2nd Subnet DHCP Server"/> RIP Protocol Control: Disable	DHCP Server Configuration <input type="radio"/> Enable Server <input checked="" type="radio"/> Disable Server Relay Agent: <input type="radio"/> 1st Subnet <input type="radio"/> 2nd Subnet Start IP Address: 192.168.1.10 IP Pool Counts: 50 Gateway IP Address: 192.168.1.1 DHCP Server IP Address for Relay Agent: <input type="text"/> DNS Server IP Address <input type="checkbox"/> Force DNS manual setting Primary IP Address: <input type="text"/> Secondary IP Address: <input type="text"/>

4.5 Upgrade Firmware for Your Router

Before upgrading your router firmware, you need to install the Router Tools. The file **RTSxxx.exe** will be asked to copy onto your computer. Remember the place of storing the execution file.

1. Go to www.draytek.com.
2. Access into **Support >> Downloads**. Please find out **Firmware** menu and click it. Search the model you have and click on it to download the newly update firmware for your router.

Model Name	Firmware Version	Release Date
Vigor120 series	3.2.2.1	26/06/2009
Vigor2100 series	2.6.2	26/02/2008
Vigor2104 series	2.5.7.3	13/02/2008
Vigor2110 series	3.3.0	25/06/2009
Vigor2200/X/WE	2.3.11	22/09/2004
Vigor2200Eplus	2.5.7	18/02/2009
Vigor2200USB	2.3.10	16/03/2005

3. Access into **Support >> Downloads**. Please find out **Utility** menu and click it.

Tools Name	Release Date	Version	OS	Support Model
Router Tools	2009/06/18	4.2.0	MS-Windows	All Modules
Syslog Tools	2009/06/18	4.2.0	MS-Windows XP MS-Vista	All Modules
VigorPro Alert Notice Tools	2009/06/03	1.1.0 (Multi-language)	MS-Windows XP MS-Vista	VigorPro 100 series VigorPro 5500 series VigorPro 5510 series VigorPro 5300 series
Smart VPN Client	2009/05/25	3.6.3 (Multi-language)	MS-Windows XP MS-Vista	All Modules
Smart Monitor	2009/03/25	2.0	MS-Windows XP	Vigor2950 series VigorPro 5510 series

4. Click on the link of **Router Tools** to download the file. After downloading the files, please decompressed the file onto your host.

5. Double click on the icon of router tool. The setup wizard will appear.

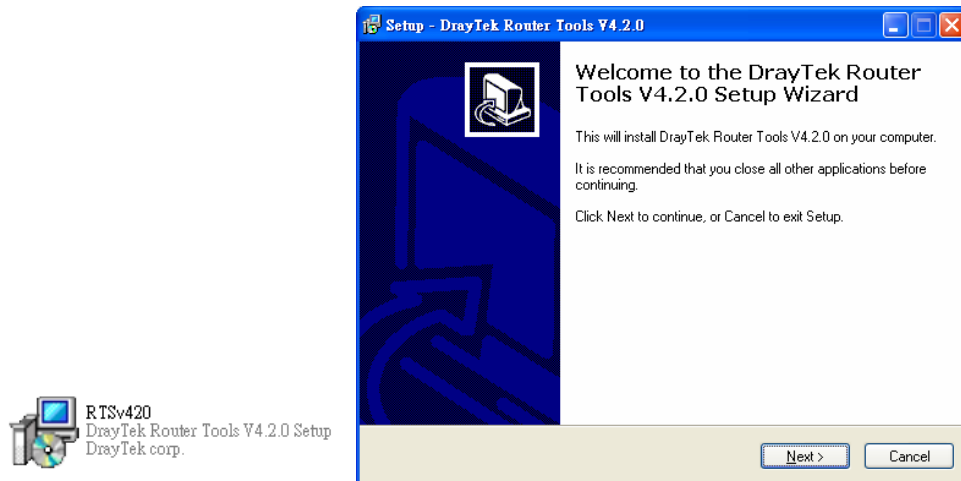

6. Follow the onscreen instructions to install the tool. Finally, click **Finish** to end the installation.
7. From the **Start** menu, open **Programs** and choose **Router Tools XXX >> Firmware Upgrade Utility**.

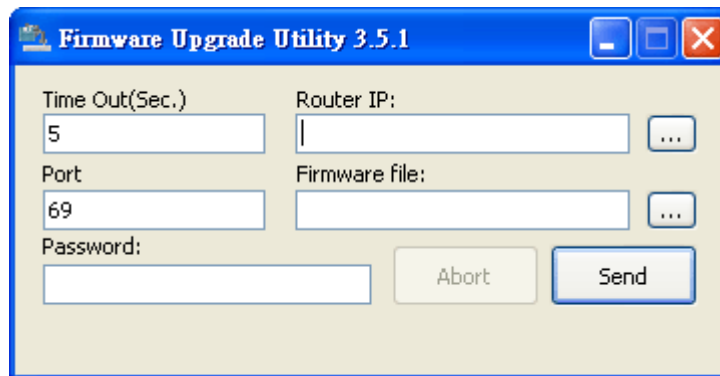

8. Type in your router IP, usually **192.168.1.1**.
9. Click the button to the right side of Firmware file typing box. Locate the files that you download from the company web sites. You will find out two files with different extension names, **xxxx.all** (keep the old custom settings) and **xxxx.rst** (reset all the custom settings to default settings). Choose any one of them that you need.

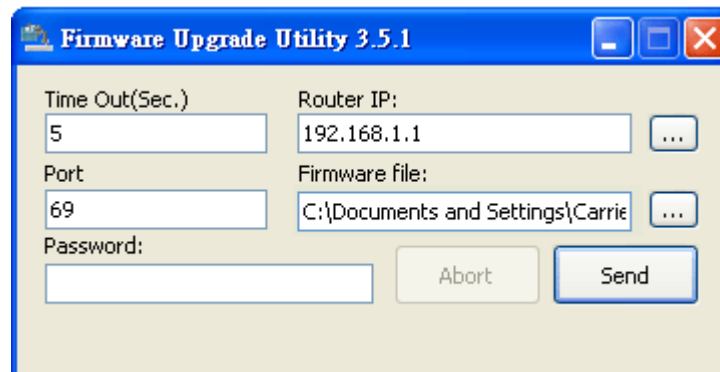

10. Click **Send**.

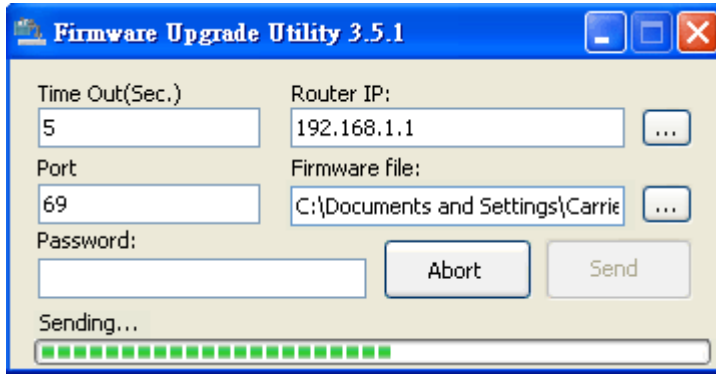

11. Now the firmware update is finished.

4.6 Request a certificate from a CA server on Windows CA Server

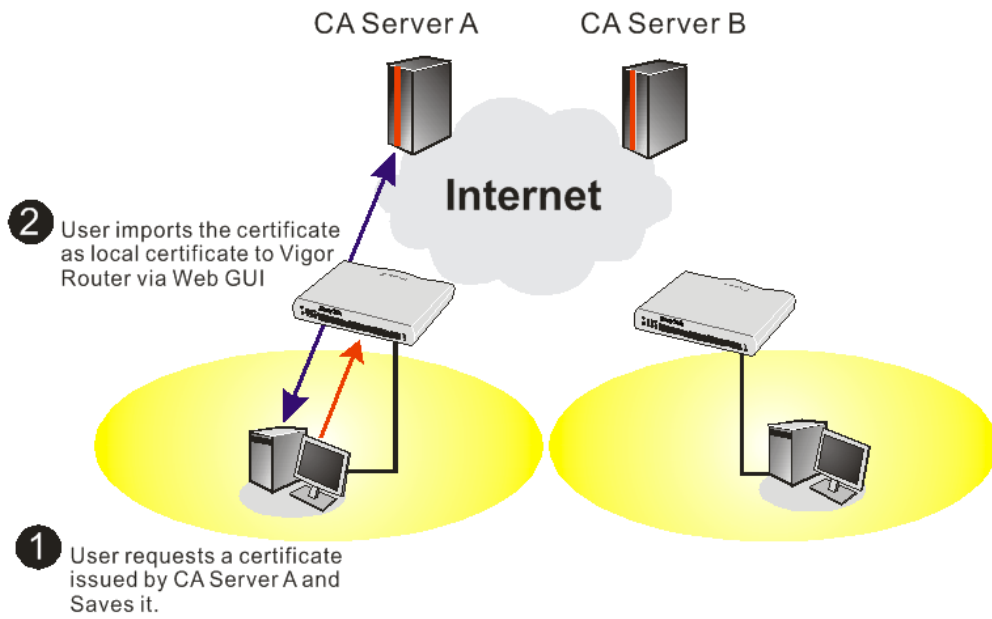

1. Go to **Certificate Management** and choose **Local Certificate**.

[Certificate Management >> Local Certificate](#)

X509 Local Certificate Configuration

Name	Subject	Status	Modify
Local	---	---	View Delete

[GENERATE](#) [IMPORT](#) [REFRESH](#)

X509 Local Certificate

- You can click **GENERATE** button to start to edit a certificate request. Enter the information in the certificate request.

[Certificate Management >> Local Certificate](#)

Generate Certificate Request

Subject Alternative Name

Type: Domain Name

IP: draytek.com

Subject Name

Country (C): TW

State (ST):

Location (L):

Organization (O): Draytek

Organization Unit (OU):

Common Name (CN):

Email (E): press@draytek.com

Key Type: RSA

Key Size: 1024 Bit

- Copy and save the X509 Local Certificate Request as a text file and save it for later use.

[Certificate Management >> Local Certificate](#)

X509 Local Certificate Configuration

Name	Subject	Status	Modify
Local	/C=TW/ST=HS/O=Draytek/OU=RD/...	Requesting	<input type="button" value="View"/> <input type="button" value="Delete"/>

X509 Local Certificate Request

```

-----BEGIN CERTIFICATE REQUEST-----
MIIBnTCCAQYCAQAwXTELMAkGA1UEBhMCVFcxCzAJBgNVBAGTAKhTMRAwDgYDVQQK
EwdEcmF5dGVrMQswCQYDVQQLLEwJSRDElMCAGCSqGSIb3DQEJARYTe3VwcG9ydEBk
cmF5dGVrLmNvbTCBnzANBgkqhkiG9w0BAQEFAAOBjQAwgYkCgYEAyZELVTVBytix
OTSZS2QdwlRe1tv1HnVmm/MFC0y9x+XEwNKG46jdGY1LSAvJTduHH9Oz4OMWx02G
mASVORtj7HbN0dYn88p1xRrQFgk8nkbMLdAgb1Ooc/1sYN/smGb4N+Pbc4VMO1VO
dKiyAPfp/2020WscDdxh/Hz23Ys8m60CAwEAaAAAMAOGCSqGSIb3DQEBBQUAA4GB
AGNB9071V44sgXwiWnXHJvdFLD0dwcQ01ZL1XRn+OVdheJjvaISCGiqzJQCkaDQ7
nacBqEc1W0chKzES0dyDc8mtIf7k+i045SeuY7nxsWZvPIOn31JMjGM2vQSVrTYu
sOvJGBHhKSkWb1RAZL5xvHjDoMX16czT1ybedZSsrJw
-----END CERTIFICATE REQUEST-----

```

- Connect to CA server via web browser. Follow the instruction to submit the request. Below we take a Windows 2000 CA server for example. Select **Request a Certificate**.

Microsoft Certificate Services -- vigor Home

Welcome

You use this web site to request a certificate for your web browser, e-mail client, or other secure program. Once you acquire a certificate, you will be able to securely identify yourself to other people over the web, sign your e-mail messages, encrypt your e-mail messages, and more depending upon the type of certificate you request.

Select a task:

- Retrieve the CA certificate or certificate revocation list
- Request a certificate
- Check on a pending certificate

Select **Advanced request**.

Microsoft Certificate Services -- vigor Home

Choose Request Type

Please select the type of request you would like to make:

User certificate request

Advanced request

Next >

Select **Submit a certificate request a base64 encoded PKCS #10 file or a renewal request using a base64 encoded PKCS #7 file**

Microsoft Certificate Services -- vigor Home

Advanced Certificate Requests

You can request a certificate for yourself, another user, or a computer using one of the following methods. Note that the policy of the certification authority (CA) will determine the certificates that you can obtain.

Submit a certificate request to this CA using a form.

Submit a certificate request using a base64 encoded PKCS #10 file or a renewal request using a base64 encoded PKCS #7 file.

Request a certificate for a smart card on behalf of another user using the Smart Card Enrollment Station.
You must have an enrollment agent certificate to submit a request for another user.

Next >

Import the X509 Local Certificate Request text file. Select **Router (Offline request)** or **IPSec (Offline request)** below.

Microsoft Certificate Services -- vigor Home

Submit A Saved Request

Paste a base64 encoded PKCS #10 certificate request or PKCS #7 renewal request generated by an external application (such as a web server) into the request field to submit the request to the certification authority (CA).

Saved Request:

```
-----BEGIN CERTIFICATE REQUEST-----
MIIBqjCCARNCQAwwQTELHakGA1UEBhMCVFcxEDAO
BgkqhkiG9wOBCQEWEYBzZXNzQGRyYX10ZMsuY29t
A4GNADCB1QKBgQDQYB7mmZFfHn9/ IeQnG03Xk++
hX4bp89cUF9d1oACGG1M/tcBoekdcZdFFFvIXcP3
x/G0A7CTv0/fQzpxroCw1JTjLSjS0/Bn9v50951G
-----END CERTIFICATE REQUEST-----
```

Base64 Encoded Certificate Request (PKCS #10 or #7):

[Browse](#) for a file to insert.

Certificate Template:

Administrator

Additional Attributes:

Attributes:

- Authenticated Session
- Basic EFS
- EFS Recovery Agent
- User
- IPSEC (Offline request)
- Router (Offline request)**
- Subordinate Certification Authority
- Web Server

Submit >

Then you have done the request and the server now issues you a certificate. Select **Base 64 encoded certificate** and **Download CA certificate**. Now you should get a certificate (.cer file) and save it.

- Back to Vigor router, go to **Local Certificate**. Click **IMPORT** button and browse the file to import the certificate (.cer file) into Vigor router. When finished, click refresh and you will find the below window showing “-----BEGIN CERTIFICATE-----.....”

Certificate Management >> Local Certificate

X509 Local Certificate Configuration

Name	Subject	Status	Modify
Local	/C=TW/ST=HS/O=Draytek/OU=RD/...	Requesting	<input type="button" value="View"/> <input type="button" value="Delete"/>

X509 Local Certificate Request

```

-----BEGIN CERTIFICATE REQUEST-----
MIIBnTCCAQYCAQAwxTELMakGA1UEBhMCFVcxZAJBgNVBAGTAkhTHRAdG9YDQYK
EwdEcmF5dGVrMQswCQYDVQQLFwJSRDEiMCAGCSqGSIb3DQEJARYTc3VwcG9ydEBk
cmF5dGVrLmNvbTCBnzANBgkqhkiG9w0BAQEFAAOBjQAwYkCgYEAyZELVTBvtix
OTSZSQdw1Reltv1HnVwm/MFC0y9x+XEWKKG46jdGY1LSAvJTduHH9Oz4OMWx02G
mASVORtj7HbNODYn88p1xRrQFgk8nkbMLdAqb1Ooc/1sYN/smGb4N+Pbo4VMO1VO
dKiyAPfp/202OWsCddxh/Hz3Ys8m60CAwEAaAAAMAOGCSqGSIb3DQEBBQUAA4GB
AGNB9071V44sgXwiWnXHJvdFLD0dwcQO1ZL1XRn+OVdheJjvaISCgiqzJQCKaDQ7
nacBqEclW0chKzES0dyDc8mtIf7k+i045SeuY7nxsWxvPIOn31JMjGMZvQSVrTYu
sOvJGBHHwKSkWb1RAZL5xvHjDoMX16czT1ybedZ3srJw
-----END CERTIFICATE REQUEST-----

```

- You may review the detail information of the certificate by clicking **View** button.

Name :	Local
Issuer :	/C=US/CN=vigor
Subject :	/emailAddress=press@draytek.com/C=TW/O=Draytek
Subject Alternative Name :	DNS:draytek.com
Valid From :	Aug 30 23:08:43 2005 GMT
Valid To :	Aug 30 23:17:47 2007 GMT

4.7 Request a CA Certificate and Set as Trusted on Windows CA Server

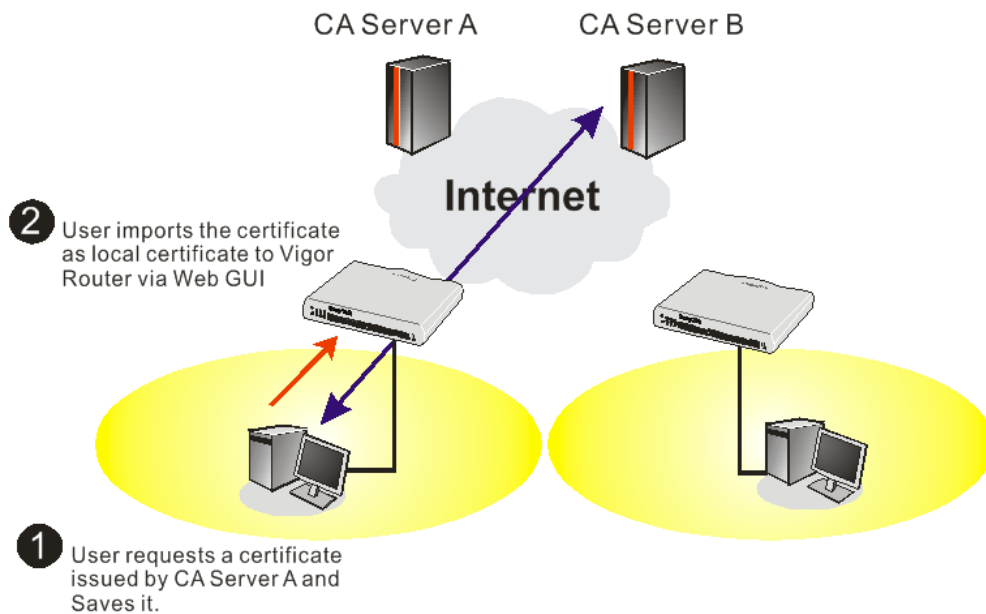

1. Use web browser connecting to the CA server that you would like to retrieve its CA certificate. Click **Retrieve the CA certificate or certificate recoring list**.

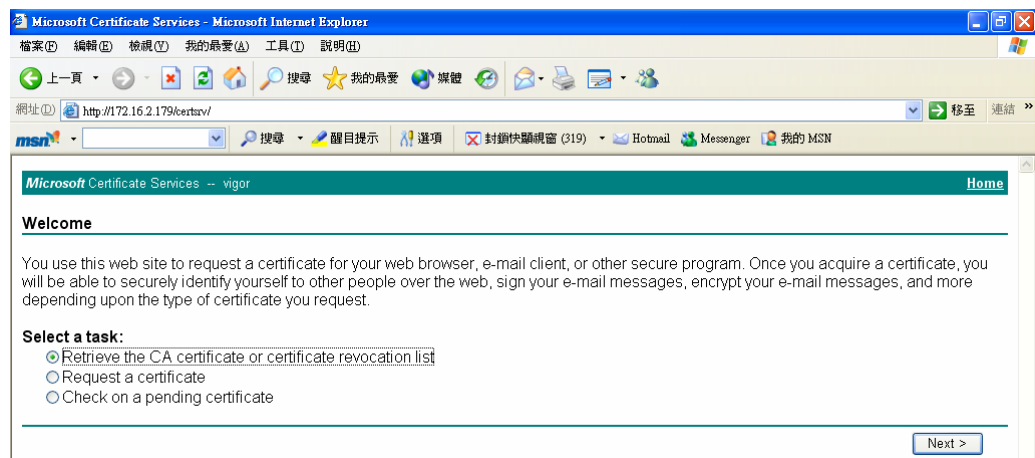

- In **Choose file to download**, click **CA Certificate Current** and **Base 64 encoded**, and **Download CA certificate** to save the .cer file.

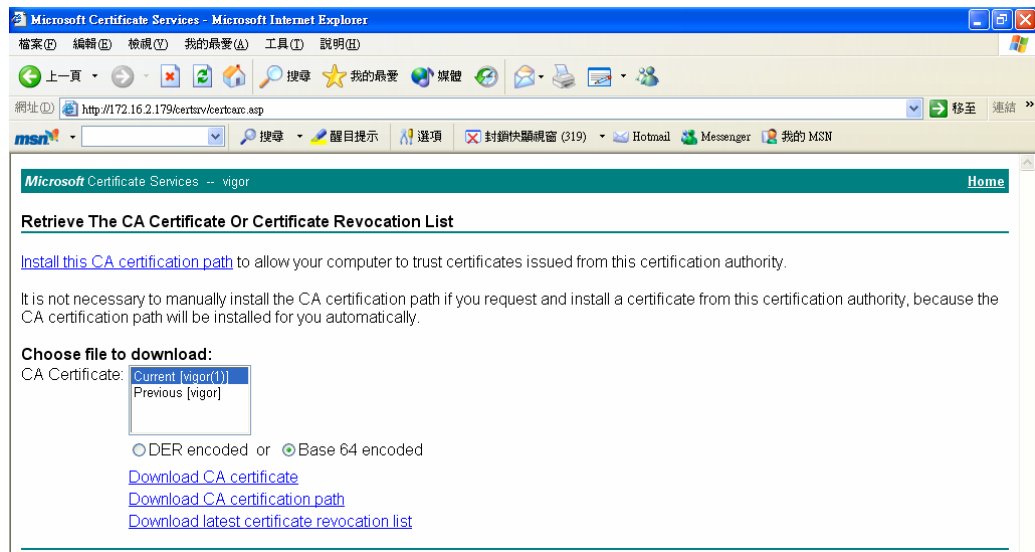

- Back to Vigor router, go to **Trusted CA Certificate**. Click **IMPORT** button and browse the file to import the certificate (.cer file) into Vigor router. When finished, click refresh and you will find the below illustration.

Certificate Management >> Trusted CA Certificate

X509 Trusted CA Certificate Configuration

Name	Subject	Status	Modify	
Trusted CA-1	/C=US/CN=vigor	Not Yet Valid	<input type="button" value="View"/>	<input type="button" value="Delete"/>
Trusted CA-2	---	---	<input type="button" value="View"/>	<input type="button" value="Delete"/>
Trusted CA-3	---	---	<input type="button" value="View"/>	<input type="button" value="Delete"/>

- You may review the detail information of the certificate by clicking **View** button.

Name :	Trusted CA-1
Issuer :	/C=US/CN=vigor
Subject :	/C=US/CN=vigor
Subject Alternative Name :	DNS:draytek.com
Valid From :	Aug 30 23:08:43 2005 GMT
Valid To :	Aug 30 23:17:47 2007 GMT

Note: Before setting certificate configuration, please go to **System Maintenance >> Time and Date** to reset current time of the router first.

4.8 How to achieve DID (Direct Inward Dialing) with SIP Alias?

SIP Alias is an alternative address for your main SIP Address. Normally, when you have a user account for one ITSP, you have one SIP address provided by the ITSP. However, with SIP alias, you can own multiple SIP addresses over one user account. When you register with a regular user account, alias are registered as well as the main SIP address. Then, when somebody dials the alias, the SIP URI bound to the alias will ring.

DID - Direct-Inward-Dial (also called DDI in Europe) is a service offered by a telephone company that provides a block of telephone numbers associated with one phone line for calling into a company's PBX system. The employees can have their extension numbers respectively, and the caller, via DID function on Vigor router, can dial to any one of the extension numbers directly without passing through auto-attendant.

Below shows a scenario:

866668@iptel.org is the main SIP trunk set on VigorIPPBX 2820 , and 3400017904@iptel.org is set as SIP alias on VigorIPPBX 2820 as well. Both share the same SIP account. When you complete the registration for the main SIP trunk, an additional registration for the SIP alias will be automatically performed. Therefore, in this case, if Benson wants to call Jacky, he has two options. One is using auto-attendant by calling 866668@iptel.org. After hearing the greeting, Benson should press the extension number 101 to call Jacky. The other is using DID by calling 3400017904@iptel.org, the call will be forwarded to extension number 101 directly by the PBX system



Follow the steps below to setup SIP Alias and achieve DID.

1. Create a SIP Alias. First of all, make sure your VoIP Service Provider supports SIP Alias. For example, iptel.org provides such service. When you register an SIP account **866668@iptel.org** on **iptel.org**, you will be provided with a sip alias **3400017904@iptel.org** as well. See below.

The screenshot shows the 'iptel.org user management' interface. At the top, there are navigation buttons: 'my account', 'phone book', 'missed calls', 'accounting', and 'speed dial'. Below this is a tabbed interface with 'general', 'privacy', 'forward', and 'other' tabs. The 'general' tab is active, displaying a registration form with fields for 'your password', 'retype password', 'first name' (tt), 'last name' (yy), 'email' (yinglqy@hotmail.com), 'phone', 'language' (English), and 'timezone' (Asia/Shanghai). A 'Save' button is located below the form. At the bottom, a section titled 'your aliases:' is highlighted with a red box, showing two entries: 'sip:3400017904@iptel.org' and 'sip:866668@iptel.org'.

2. Setup SIP account on VigorIPPBX 2820. Open the **IP PBX>>Line Setting>>SIP Trunk** page and configure the SIP account as follows.

[IP PBX >> SIP Trunk List](#)

The screenshot shows the 'SIP Trunk Index 1' configuration form. A red box highlights the following fields: Profile Name (iptel), Register via (Auto), SIP Local Port (5070), Domain/Realm (iptel.org), Proxy (iptel.org), Proxy Port (5060), Display Name (866668), Account Number/Name (866668), Authentication ID (checked, 866668), and Password (****). Other fields include Expiry Time (1 hour, 3600 sec), Trunk number (001), Office hours answer mode (Auto Attendant), and Non-Office hours answer mode (Auto Attendant). A note at the bottom states: 'Note: SIP Local Port can not be equal to PBX Proxy Port.' There are 'OK' and 'Cancel' buttons at the bottom.

- Setup SIP Alias on VigorIPPBX 2820. Open the **IP PBX>>SIP Trunk List** page and click on **Alias List** to enter the SIP Alias setup page.

[IP PBX >> SIP Trunk List](#)

SIP Trunk List Refresh Seconds: | [Refresh](#) |

Index	Profile Name	Domain/Realm	Proxy	Account Number/Name	Trunk Number	Status
1.	iptel	iptel.org	iptel.org	866668	001	-
2.					002	-
3.					003	-
4.					004	-
5.					005	-
6.					006	-

R: Success registered on SIP server
-: Fail to register on SIP server

[Alias List](#)

[IP PBX >> Alias](#)

Alias List

Index	Profile Name	Number	Office Hours	Non Office Hours	Active	Trunk
1.			Auto Attendant	Auto Attendant	No	
2.			Auto Attendant	Auto Attendant	No	
3.			Auto Attendant	Auto Attendant	No	
4.			Auto Attendant	Auto Attendant	No	
5.			Auto Attendant	Auto Attendant	No	
6.			Auto Attendant	Auto Attendant	No	
7.			Auto Attendant	Auto Attendant	No	
8.			Auto Attendant	Auto Attendant	No	
9.			Auto Attendant	Auto Attendant	No	
10.			Auto Attendant	Auto Attendant	No	

<< [1-10](#) | [11-20](#) | [21-30](#) | [31-40](#) | [41-50](#) >> [Next](#) >>

- Press one index and input the SIP Alias in the **Alias Number** fields. Select the associated SIP account from **Alias of SIP Trunk**, which was created in step 2. Route the call to Jacky by selecting **Forward To Extension** and the extension profile **1-101**.

[IP PBX >> Alias](#)

Alias 1.

Active Enable Disable

Alias Name

Alias Number

Alias of SIP Trunk

Answer Mode

Office hours answer mode Extension

Non-Office hours answer mode

IP PBX >> Alias

Alias List

Index	Profile Name	Number	Office Hours	Non Office Hours	Active	Trunk
1.	Jacky	3400017904	Ext.101	Auto Attendant	Yes	1 - iptel
2.			Auto Attendant	Auto Attendant	No	
3.			Auto Attendant	Auto Attendant	No	
4.			Auto Attendant	Auto Attendant	No	
5.			Auto Attendant	Auto Attendant	No	
6.			Auto Attendant	Auto Attendant	No	
7.			Auto Attendant	Auto Attendant	No	
8.			Auto Attendant	Auto Attendant	No	
9.			Auto Attendant	Auto Attendant	No	
10.			Auto Attendant	Auto Attendant	No	

5. The configuration is completed. Make sure the extension number 101 is registered. Next, Benson can make a direct call to Jacky by calling 3400017904@iptel.org.

IP PBX >> PBX Status

Extension Monitor

Refresh Seconds: [Refresh](#)

Index	Name	Extension	IP	Status	Peer ID
1	Jacky	101	192.168.1.12	Online	
2	Stephen	222	192.168.1.10	Online	
3	Joseph	223	202.211.100.61	Online	
4	Mark	204		Offline	
5	Mandy	221	192.168.1.1	Online	
6	---	---		Offline	
7	---	---		Offline	
8	---	---		Offline	
9	---	---		Offline	
10	---	---		Offline	

<< [1-10](#) | [11-20](#) | [21-30](#) | [31-40](#) | [41-50](#) | [51-52](#) >>[Next](#) >>

4.9 How to use Call Parking?

Call parking allows you to hold the call on a telephone set and pick it up at a different phone. Below shows a brief illustration for call parking application.

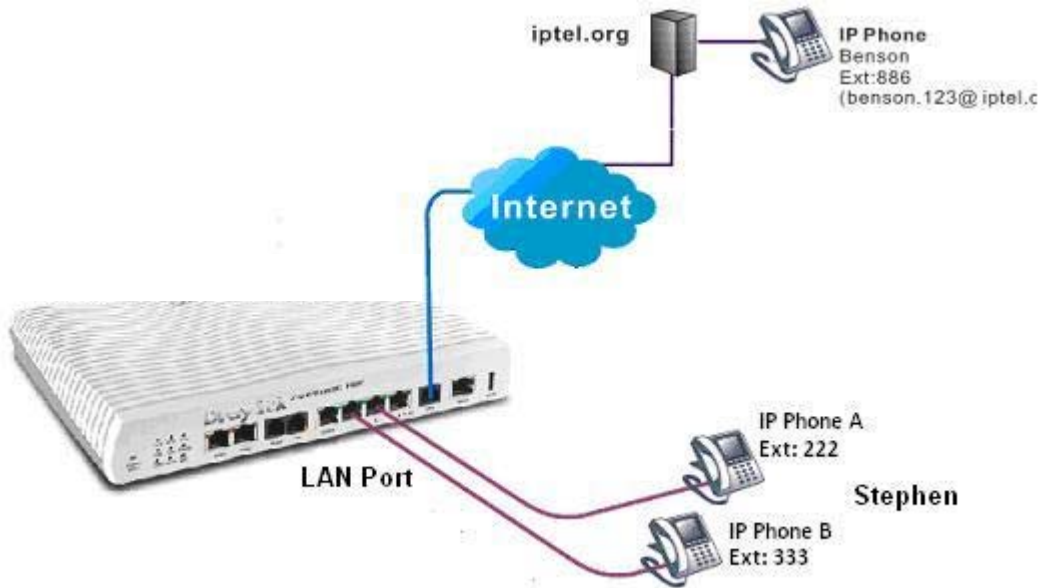

Benson calls extension 222. Stephen picks IP Phone A up and tells Benson that he wants to park the call for transferring to another phone to continue the conversation.

To park a call, Stephen can perform the following actions on IP Phone A:

1. Press the **transfer** button on IP Phone A.
2. Dial the **call park number, 777**.
3. Stephen hears an announcement that “Your parking number is XXXXX” (for example 22201).
4. Hang Up.

Please take notice:

- If there is no transfer button on your phone, please try the # button. Or, check the user guide of your hardware/software IP phone to find the button for call parking.
- The **call park number** is defined in the **IP PBX>>PBX System>>SIP Proxy Setting** page as **Parking Server Number**.

[IP PBX >> PBX System](#)

SIP Proxy Setting

SIP Local Port	5060
SIP Proxy Realm	PBX.com
Parking Server Number	777
RTP Local Port Start	15050
RTP Local Port End	20000

1. When an incoming call is parked, a certain extension will be assigned to it temporarily and the number will be announced to you. In this example, the announcement “Your parking number is 22201” informs you of the new extension 22201. Next, you can dial the new extension to retrieve the call from a different phone. The new extension number may also be displayed on your IP phone.
2. After you hang up the call, it is left on hold with the new extension and the caller will be listening to the music on hold.
3. The call will remain on hold before someone retrieves it or the caller hangs up.

To retrieve a parked call, Stephen can perform following actions on IP Phone B:

1. Pick up the phone and listen for a dial tone.
2. Dial 22201(the announced new extension) to continue the conversation.

Call Parking Usage

Call Parking is similar to Call Transfer. But Call Transfer is a “blind” transfer. Sometimes you are required to confirm if a person is available or not before transferring a call. For example, Mike is manager and Jane is his secretary. When there is an incoming call, Jane always parks the call. After the announcement, Jane hangs up and dials the extension of Mike and informs him of the park number to retrieve the call. If Mike refuses to take the call, Jane hangs up and dials park number by herself to pick up the call back and make some excuses. With Call Transfer, Jane can just simply transfer the call to Mike directly.

Another useful scenario: During a conversation, you may need to go to another office for some reason (for example, to check an important file). You can park the call and continue the conversation from another phone at the other office.

4.10 How to set up VigorPhone 350 with Vigor IPPBX2820 series by using Auto-Provisioning?

DrayTek Vigor IPPBX 2820/Vigor IPPBX 2820n supports the function of auto-provisioning. VigorPhone 350 is also capable of auto-provisioning, it can get a configuration text file from the Vigor IPPBX 2820 series. The configuration file contains SIP settings that the SIP devices can register with Vigor IPPBX 2820 series.

Vigor IPPBX 2820

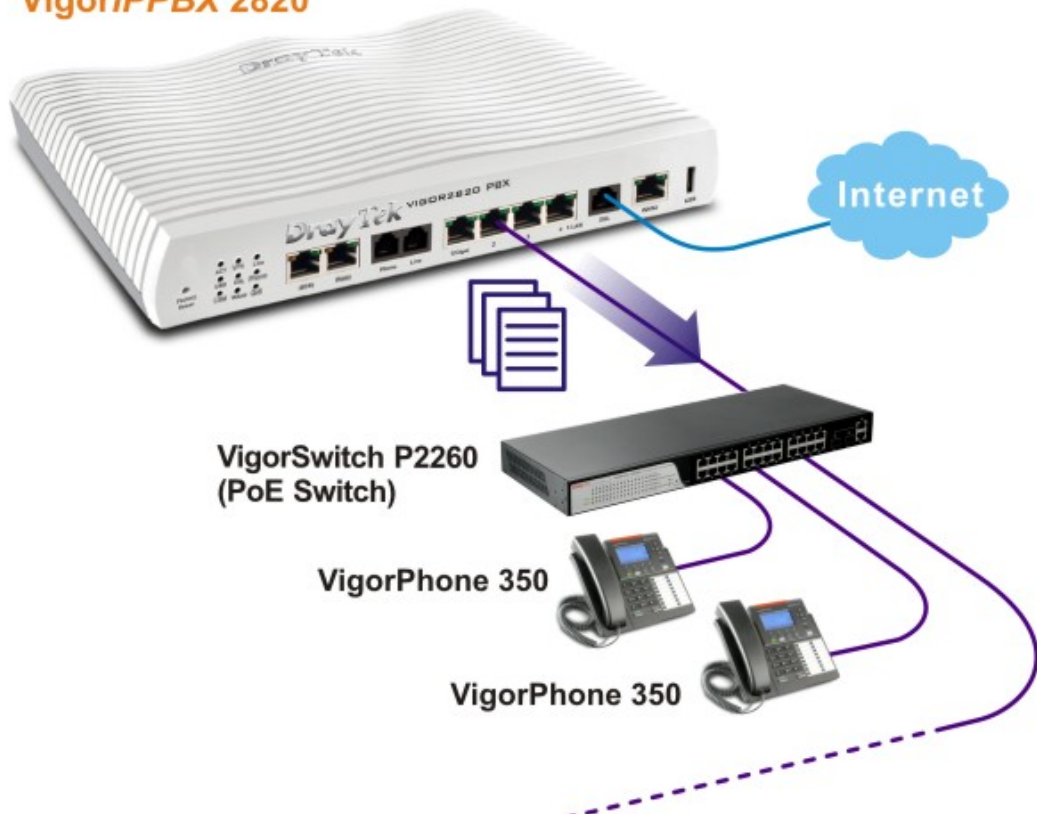

1. Configure the extension number and password for each IP phone on Vigor IPPBX 2820. You can configure extensions from IP PBX Wizard.

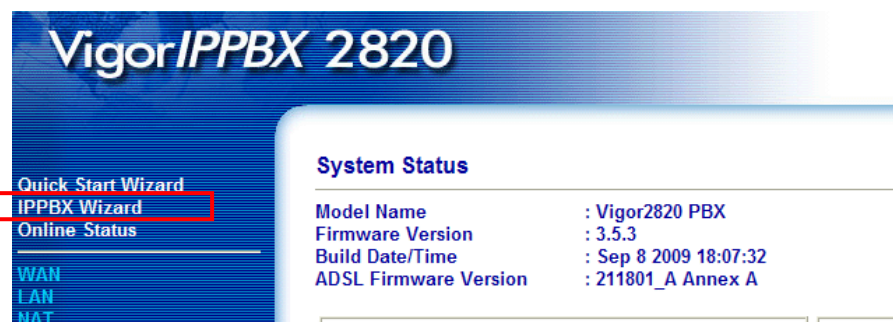

- Click **IPPBX Wizard** to get the first screen as shown below.

IPPBX Wizard

Extension & Groups Setup : Index 1

Extension Group Name:	<input type="text" value="VigorPhone"/>	(for example : sales)
Extension Group Number:	<input type="text" value="910"/>	(for example : 100)
Start Number of the extension Group:	<input type="text" value="911"/>	(for example : 101)
Number of extensions in this group:	<input type="text" value="10"/>	(for example : 10, max = 20)
<input type="button" value="OK"/>		

Index	Group Name	Group Extension	Hunt List(Max 20 Extension)
1.	VigorPhone	910	911-920
2.			
3.			
4.			
5.			
6.			
7.			

Type the extension group name, group number, start number, and number of extension fields. Click **OK** to save them. The new added group will be displayed on the screen. Then click **Next** to access into next web page.

- In the SIP Trunk Setup page, you can set up to six SIP profiles outside lines at one time.

IPPBX Wizard

Sip Trunk Setup : Index 1

Profile Name:	<input type="text"/>	(11 characters max.)
Domain/Realm:	<input type="text"/>	(63 characters max.)
Proxy:	<input type="text"/>	(63 characters max.)
Account Number/Name:	<input type="text"/>	(63 characters max.)
Password:	<input type="text"/>	(63 characters max.)
Trunk number:	<input type="text" value="001"/>	(3 characters max.)
<input type="button" value="OK"/>		

Index	Profile Name	Domain/Realm	Proxy	Account Number/Name	Trunk Number
1.					001
2.					002
3.					003
4.					004
5.					005
6.					006

Type the profile name, domain/realm, proxy, account number/name, password and trunk number fields, then click **OK** to save them. The new added profile will be displayed on the screen.

Index	Profile Name	Domain/Realm	Proxy	Account Number/Name	Trunk Number
1.	SalesMarket	192.168.1.55	nat.draytel.org:5065	salesgroup	001
2.					002
3.					003
4.					004
5.					005
6.					006

- Click **Next** to access into office hours setup page.

IPPBX Wizard

Office Hours Setup

Now, You can make the work time schedule of your office.

	Hour :	Min
When do you start working in the morning	00 ▾	00 ▾
When do you have a rest at noon	00 ▾	00 ▾
When do you start working in the afternoon	00 ▾	00 ▾
When do you leave the office	00 ▾	00 ▾
Is this schedule available at weekend?	<input type="radio"/> Yes <input checked="" type="radio"/> No	

Please specify office hours including starting point and ending point on duty day(s). Then, click **Finish** to save the settings and exit the wizard.

work time schedule of your office.

	Hour :	Min
ing in the morning	08 ▾	00 ▾
at at noon	12 ▾	00 ▾
ing in the afternoon	13 ▾	00 ▾
office	17 ▾	30 ▾
e at weekend?	<input type="radio"/> Yes <input checked="" type="radio"/> No	

- After finishing the Wizard, please go to **IPPBX>Extension** to configure the Extension Number and the Password settings.

IP PBX >> Extension

Internal Phone Extension

Index	Ext.	Name	Email Address	Outgoing Call	Status
1.	911	---		SIP1 SIP2 SIP3 SIP4 SIP5 SIP6 ISDN1-TE ISDN2-TE	v
2.	912	---		SIP1 SIP2 SIP3 SIP4 SIP5 SIP6 ISDN1-TE ISDN2-TE	v
3.	913	---		SIP1 SIP2 SIP3 SIP4 SIP5 SIP6 ISDN1-TE ISDN2-TE	v
4.	914	---		SIP1 SIP2 SIP3 SIP4 SIP5 SIP6 ISDN1-TE ISDN2-TE	v
5.	915	---		SIP1 SIP2 SIP3 SIP4 SIP5 SIP6 ISDN1-TE ISDN2-TE	v

IP PBX >> Extension Profile

Internal Phone Extension Index 1

Internal Phone Extension Active Enable Disable

Extension Number

User Name

Authentication

Password

E-mail Address

Voice mail Password

MWI

Notify User who Subscribed Force Notify User

Outgoing Call Use

SIP1 SIP2 SIP3 SIP4 SIP5 SIP6 ISDN1-TE ISDN2-TE

Answer Mode

No answer after sec then

Busy then

Not on-line

- Then connect VigorPhone to the network. Each user of VigorPhone can get the extension number/password respectively.
- The log-in request will be displayed on the screen of the phone. Please input the extension number. Press OK.

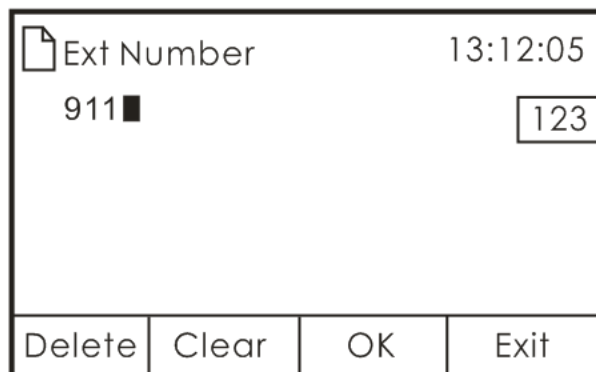

8. Next, input the password. Press **OK**.

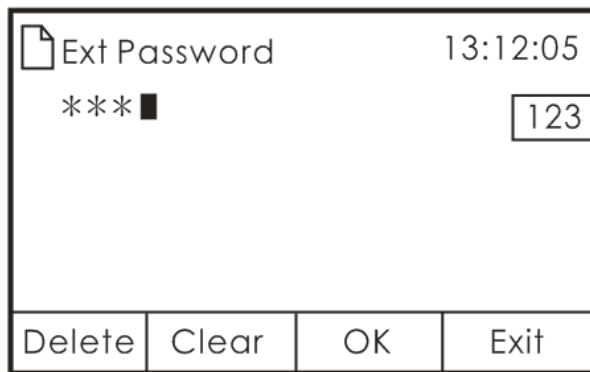

9. VigorPhone can automatically configure itself with settings coming from VigorIPPBX 2820. Successful message will be shown as below. Now, all the configurations have been done.

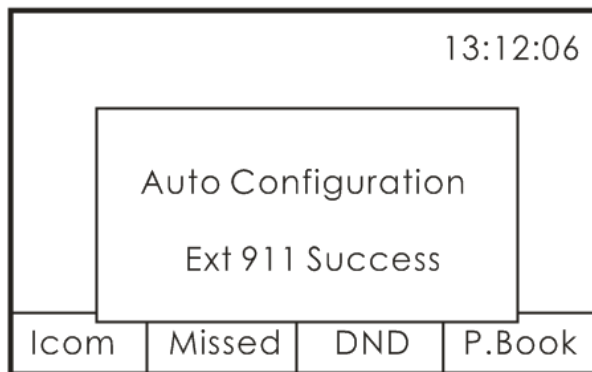

10. Now, the extension number has been registered by VigorPhone successfully. (See the number on the right side of the arrow.)

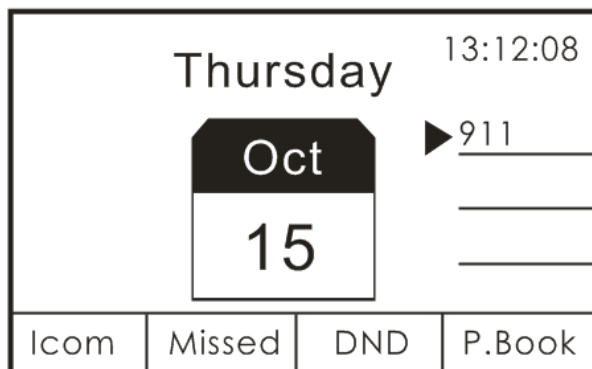

4.11 How to configure Hunt Group?

Hunt Group allows a caller to automatically find an available callee from among a group of extensions. You may assign some extensions to a Hunt Group. The incoming call will search for the first available extension. Each extension will be tried until a “free” extension is reached. If an IP phone is busy or hasn’t registered its extension to VigorIPPBX 2820 yet, its extension will be skipped. The caller hears the busy tone only when all lines are engaged.

VigorIPPBX 2820 supports up to 10 Hunt Groups. Up to 20 extensions can be assigned to each Hunt Group. And each extension can be assigned to more than one Hunt Group.

[IP PBX >> PBX System](#)

PBX System

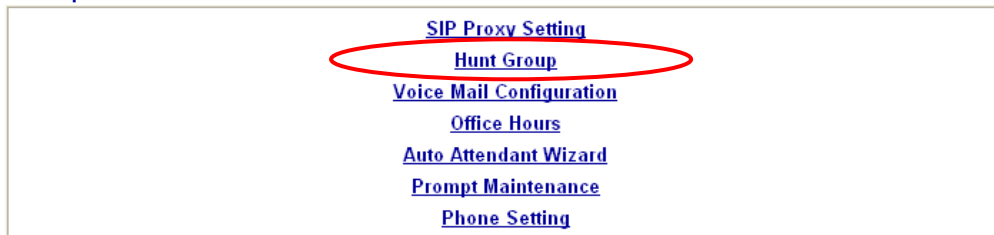

There are two modes (Hunt Rule) supported by VigorIPPBX 2820, **Simultaneously** and **Sequentially**.

Simultaneously — If an incoming call rings on a Hunt Group, all extensions belong to this group will ring except for the IP phones which are busy or offline.

Sequentially — If an incoming call rings on a Hunt Group, the first extension in the list is tried. If the call is not answered within 15 seconds, it will move to the next available extension in the list. The IP phones which are busy or offline will be skipped.

Example 1 for Simultaneously

Extension 100 is configured as a Hunt Group’s extension number. When someone calls 100, VigorIPPBX 2820 tries to ring 101, 102 and 103 simultaneously at once.

Ext 101 is busy, no ring

Ext 102 rings - answers call

Ext 103 is available for next call – no ring

Example 2 for Sequentially

Extension 200 is configured as a Hunt Group’s extension number. When someone calls 200, VigorIPPBX 2820 tries to ring 201 then 202 then 203 then 204.

Ext 201 rings - no answer, then moves to next

Ext 202 is busy, no ring and moves to next

Ext 203 rings - answers call

Ext 204 is available for next call – no ring

How to setup Hunt Group for Example 1 and 2 ?

1. Configure extensions for IP phones.

[IP PBX >> Extension](#)

Internal Phone Extension

Index	Ext.	Name	Email Address	Outgoing Call	Status
1.	101	Jacky		SIP1	v
2.	102	Stephen		SIP1	v
3.	103	Joseph		SIP1	v
4.	201	James		SIP1	v
5.	202	Kevin		SIP1	v
6.	203	Jimmy		SIP1	v
7.	204	Fred		SIP1	v
8.	---	---		SIP1 SIP2 SIP3 SIP4 SIP5 SIP6 ISDN2-TE	x
9.	---	---		SIP1 SIP2 SIP3 SIP4 SIP5 SIP6 ISDN2-TE	x
10.	---	---		SIP1 SIP2 SIP3 SIP4 SIP5 SIP6 ISDN2-TE	x

<< [1-10](#) | [11-20](#) | [21-30](#) | [31-40](#) | [41-50](#) >>

[Next >>](#)

2. Open [IP PBX >> PBX System >> Hunt Group](#). Configure the following two groups.

[IP PBX >> PBX System](#)

Hunt Group

Index	Group Name	Group Extension	Hunt List (Max 20 Extension)
1.	Sales	100	101, 102, 103
2.	RD	200	201, 202, 203, 204
3.			
4.			
5.			
6.			
7.			
8.			
9.			
10.			

For the Hunt Group of Sales department, **Hunt Group Name** is locally significant for identification. **Hunt Group Extension** must be different from all the other extension numbers. Select **Simultaneously** as **Hunt Rule**.

Hunt Groups Index 1

Hunt Group Name	Sales
Hunt Group Extension	100
Hunt Rule	Simultaneously

Hunt List (Maximum Of Group Member:20)

Available		Chosen
4 - 201	<input type="button" value="Add >>"/> <input type="button" value="Add All"/> <input type="button" value="Remove <<"/> <input type="button" value="Remove All"/> <input type="button" value="Move Up"/> <input type="button" value="Move Down"/>	1 - 101
5 - 202		2 - 102
6 - 203		3 - 103
7 - 204		
8 - ----		
9 - ----		
10 - ----		
11 - ----		
12 - ----		
13 - ----		
14 - ----		
15 - ----		
16 - ----		
17 - ----		
18 - ----		
19 - ----		
20 - ----		
21 - ----		
22 - ----		
23 - ----		
24 - ----		

For the Hunt Group of RD department, **Hunt Group Name** is locally significant for identification. **Hunt Group Extension** must be different from all the other extension numbers. Select **Sequentially** as **Hunt Rule**. You can use **Move Up** and **Move Down** buttons to adjust the sequence of the extensions.

Hunt Groups Index 2

Hunt Group Name	RD
Hunt Group Extension	200
Hunt Rule	Sequentially

Hunt List (Maximum Of Group Member:20)

Available		Chosen
1 - 101	<input type="button" value="Add >>"/> <input type="button" value="Add All"/> <input type="button" value="Remove <<"/> <input type="button" value="Remove All"/> <input type="button" value="Move Up"/> <input type="button" value="Move Down"/>	4 - 201
2 - 102		5 - 202
3 - 103		6 - 203
8 - ----		7 - 204
9 - ----		
10 - ----		
11 - ----		
12 - ----		
13 - ----		
14 - ----		
15 - ----		
16 - ----		
17 - ----		
18 - ----		
19 - ----		
20 - ----		
21 - ----		
22 - ----		
23 - ----		
24 - ----		
25 - ----		

How to call a Hunt Group?

Method 1:

You may call the VigorIPPBX 2820 first, and dial the Hunt Group Extension number. In the above two examples, when you dial 100, extensions 101, 102 and 103 ring at the same time. When you dial 200, extension 201 rings first, then 202, next 203 and finally 204 rings.

Method 2:

With auto-attendant, after hearing the greeting, you may dial 1. The extensions 101, 102 and 103 ring simultaneously. Or, you may dial 2 and extension 201 ring first, then 202, next 203 and finally 204 rings.

IP PBX >> PBX System

Auto Attendant Wizard - Office Hours

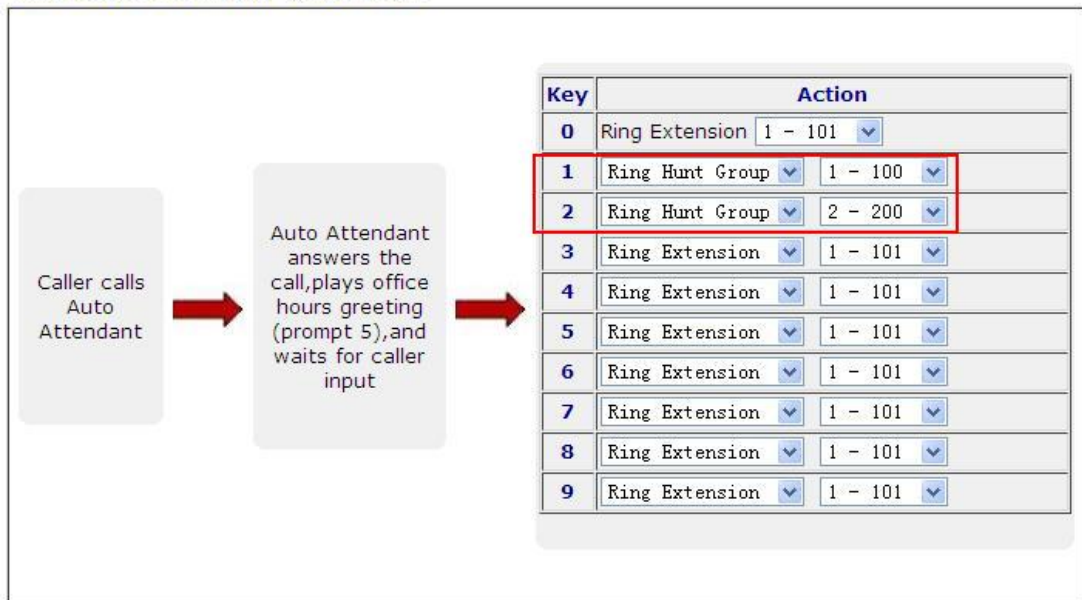

Tip: If users in the **Hunt Group** leave their desks, they would turn on **Do Not Disturb** at their extensions. Thus, the incoming call will search next available extension immediately.

4.12 How to use Auto Attendant?

IVR, Interactive Voice Response, is a technology that allows callers to interact with the communication system over the telephone.

Auto Attendant is a technology that automates interactions with telephone callers. It allows callers to be automatically transferred to an extension without the intervention from a receptionist or telephone operator.

VigorIPPBX 2820 supports IVR and Auto Attendant. When someone calls in, VigorIPPBX 2820 automatically plays the recorded message like "Thanks for calling Draytek Corporation. For sales, press 1; for support, press 2, etc." After pressing a number, the caller will be transferred to the extension he would like to or an operator. You can customize the auto attendant to play greeting messages based on the time and day settings such as office hours, after office hours, weekends and holidays

Configure Auto Attendant on VigorIPPBX 2820

We will take an example to explain the common configuration. In this example, we will present callers with options so that they can be directed to the proper extension. During the office hours, the system will ask the users to dial 1 for support department, 2 for sales department, 3 for product advertisement and 0 to speak with the receptionist. And, during the non-office hours, the system will play product advertisement.

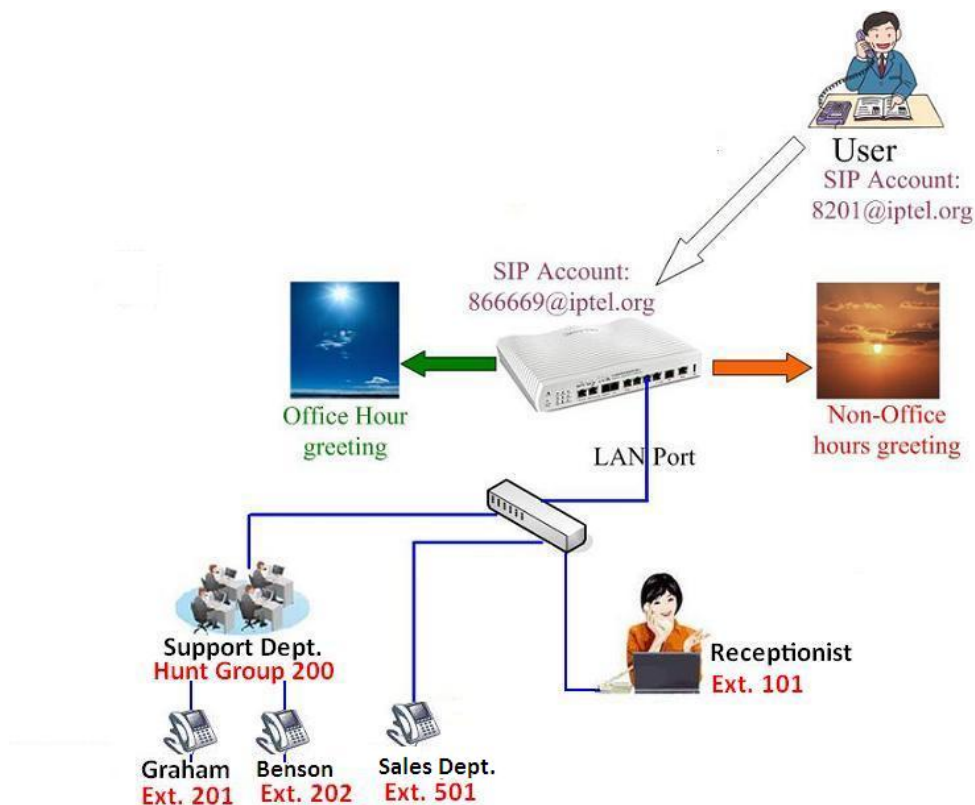

1. The first step is to record the prompts.

For the office hours greeting:

- Connect a phone to the FXS port on VigorIPPBX 2820 directly.
- Dial **** to access IVR system.
- After hearing the prompt, dial **1155#** to start recording the **Prompt 5** for the office hours greeting. "Thank you for calling Draytek Company. If you know the

extension of the person you'd like to reach, you may dial it now. Otherwise, please choose from the following options. For technical support, press "1". For sales, press "2". For new products introduction, press "3". Otherwise press "0" for the receptionist."

- When you finish the record, press #.
- Dial **1255#** to hear the office hours greeting (**Prompt 5**) that you have recorded. If you are not satisfied with the result, dial **1155#** to record it again.

For the non-office hours greeting:

- Connect a phone to the FXS port on Vigor*IPPBX* 2820 directly.
- Dial **** to access IVR system.
- After hearing the prompt, dial **1156#** to start recording the **Prompt 6** for the non-office hours greeting. "Thank you for calling Draytek Company. We are currently unavailable to take your call. Our business hours are nine to six, Monday through Friday. If you want to leave a message, please press "0" to leave a message for the receptionist. If you want to get new product information, please press 1 through 9".
- When you finish the record, press #.
- Dial **1256#** to hear the non-office hours greeting (**Prompt 6**) that you have recorded.
- If you are not satisfied with the result, dial **1156#** to record it again.

For the new product advertisement:

- Connect a phone to the FXS port on Vigor*IPPBX* 2820 directly.
- Dial **** to access IVR system.
- After hearing the prompt, dial **1151#** to start recording the **Prompt 1** for the new product advertisements. "The Vigor*IPPBX* 2820 is an IP-PBX integrated with DrayTek's fully-featured Vigor2820 ADSL Router..."
- When you finish the record, press #.
- Dial **1251#** to hear the new product advertisement (**Prompt 1**) that you have recorded.
- If you are not satisfied with the result, dial **1151#** to record it again.

- After the sounds have been recorded, you have to create the extensions that needed in the IVR. Extensions for each phone are configured as follows.

[IP PBX >> Extension](#)

Internal Phone Extension

Index	Ext.	Name	Email Address	Outgoing Call	Status
1.	101	receptionist		SIP1	v
2.	501	Jacky		SIP1	v
3.	201	Graham		SIP1	v
4.	202	Benson		SIP1	v
5.	205	Kevin		SIP1	v
6.	203	Jimmy		SIP1	v
7.	204	Fred		SIP1	v
8.	---	---		SIP1 SIP2 SIP3 SIP4 SIP5 SIP6 ISDN2-TE	x
9.	---	---		SIP1 SIP2 SIP3 SIP4 SIP5 SIP6 ISDN2-TE	x
10.	---	---		SIP1 SIP2 SIP3 SIP4 SIP5 SIP6 ISDN2-TE	x

<< [1-10](#) | [11-20](#) | [21-30](#) | [31-40](#) | [41-50](#) >>

[Next >>](#)

Configure extension for the support department. It is a hunt group. If the hunt rule is set with **Sequentially**, the extension 201 ring first, then 202, 205, 203 and finally 204 rings one by one when someone calls 200. If the hunt rule is set with **Simultaneously**, extensions 201, 202, 203, 204 and 205 ring at the same time when someone calls 200.

[IP PBX >> PBX System](#)

Hunt Groups Index 1

Hunt Group Name	<input type="text" value="Support"/>
Hunt Group Extension	<input type="text" value="200"/>
Hunt Rule	<input type="text" value="Sequentially"/> ▾
Hunt List (Maximum Of Group Member:20)	
Available	Chosen
<ul style="list-style-type: none"> 1 - 101 2 - 501 8 - --- 9 - --- 10 - --- 11 - --- 12 - --- 13 - --- 14 - --- 15 - --- 16 - --- 17 - --- 18 - --- 19 - --- 20 - --- 21 - --- 22 - --- 	<ul style="list-style-type: none"> 3 - 201 4 - 202 5 - 205 6 - 203 7 - 204
<input type="button" value="Add >>"/> <input type="button" value="Add All"/> <input type="button" value="Remove <<"/> <input type="button" value="Remove All"/> <input type="button" value="Move Up"/> <input type="button" value="Move Down"/>	

- Choose **Auto Attendant** for Office hours and Non-office hours for the SIP trunk. In this example, when you call [866669@iptel.org](tel:866669@iptel.org) during the office hours, you will hear office hours greeting (**Prompt 5**): during the non-office hours, you will hear the non-office hours greeting (**Prompt 6**).

IP PBX >> SIP Trunk List

SIP Trunk Index 1

Profile Name	<input type="text" value="iptel"/>
Register via	<input type="button" value="Auto"/> ▾
SIP Local Port	<input type="text" value="5070"/>
Domain/Reallm	<input type="text" value="iptel.org"/>
Proxy	<input type="text" value="iptel.org"/>
Proxy Port	<input type="text" value="5060"/>
Display Name	<input type="text" value="866669"/>
Account Number/Name	<input type="text" value="866669"/>
<input checked="" type="checkbox"/> Authentication ID	<input type="text" value="866669"/>
Password	<input type="text" value="****"/>
Expiry Time	<input type="button" value="1 hour"/> ▾ <input type="text" value="3600"/> sec
Trunk number	<input type="text" value="001"/>
Office hours answer mode	<input type="button" value="Auto Attendant"/> ▾
Non-Office hours answer mode	<input type="button" value="Auto Attendant"/> ▾

Note: SIP Local Port can not be equal to PBX Proxy Port.

- Make sure the system time is synchronized from the **System Maintenance >> Time and Date** page.

System Maintenance >> Time and Date

Time Information

Current System Time	<input type="text" value="2007 Jun 28 Thu 5 : 53 : 42"/>	<input type="button" value="Inquire Time"/>
---------------------	--	---

Time Setup

<input type="radio"/> Use Browser Time	
<input checked="" type="radio"/> Use Internet Time Client	
Time Protocol	<input type="button" value="NTP (RFC-1305)"/> ▾
Server IP Address	<input type="text" value="pool.ntp.org"/>
Time Zone	<input type="button" value="(GMT) Greenwich Mean Time : Dublin"/> ▾
Enable Daylight Saving	<input type="checkbox"/>
Automatically Update Interval	<input type="button" value="30 min"/> ▾

- Configure the Office hours from the **IP PBX >> PBX System >> Office Hours** setup page. Suppose the holidays are January 1 to January 3, January 20 and February 15. Based on the above configuration, the router will configure the settings for the non-office hours automatically.

IP PBX >> PBX System

Office Hours

Index	Enable	Office Hour Start (HHMM)	Office Hour End (HHMM)	Weekdays
1	<input checked="" type="checkbox"/>	09 00	18 00	<input type="checkbox"/> Sun <input checked="" type="checkbox"/> Mon <input checked="" type="checkbox"/> Tue <input checked="" type="checkbox"/> Wed <input checked="" type="checkbox"/> Thu <input checked="" type="checkbox"/> Fri <input type="checkbox"/> Sat
2	<input type="checkbox"/>	00 00	00 00	<input type="checkbox"/> Sun <input type="checkbox"/> Mon <input type="checkbox"/> Tue <input type="checkbox"/> Wed <input type="checkbox"/> Thu <input type="checkbox"/> Fri <input type="checkbox"/> Sat
3	<input type="checkbox"/>	00 00	00 00	<input type="checkbox"/> Sun <input type="checkbox"/> Mon <input type="checkbox"/> Tue <input type="checkbox"/> Wed <input type="checkbox"/> Thu <input type="checkbox"/> Fri <input type="checkbox"/> Sat
4	<input type="checkbox"/>	00 00	00 00	<input type="checkbox"/> Sun <input type="checkbox"/> Mon <input type="checkbox"/> Tue <input type="checkbox"/> Wed <input type="checkbox"/> Thu <input type="checkbox"/> Fri <input type="checkbox"/> Sat
5	<input type="checkbox"/>	00 00	00 00	<input type="checkbox"/> Sun <input type="checkbox"/> Mon <input type="checkbox"/> Tue <input type="checkbox"/> Wed <input type="checkbox"/> Thu <input type="checkbox"/> Fri <input type="checkbox"/> Sat
6	<input type="checkbox"/>	00 00	00 00	<input type="checkbox"/> Sun <input type="checkbox"/> Mon <input type="checkbox"/> Tue <input type="checkbox"/> Wed <input type="checkbox"/> Thu <input type="checkbox"/> Fri <input type="checkbox"/> Sat
7	<input type="checkbox"/>	00 00	00 00	<input type="checkbox"/> Sun <input type="checkbox"/> Mon <input type="checkbox"/> Tue <input type="checkbox"/> Wed <input type="checkbox"/> Thu <input type="checkbox"/> Fri <input type="checkbox"/> Sat
8	<input type="checkbox"/>	00 00	00 00	<input type="checkbox"/> Sun <input type="checkbox"/> Mon <input type="checkbox"/> Tue <input type="checkbox"/> Wed <input type="checkbox"/> Thu <input type="checkbox"/> Fri <input type="checkbox"/> Sat
9	<input type="checkbox"/>	00 00	00 00	<input type="checkbox"/> Sun <input type="checkbox"/> Mon <input type="checkbox"/> Tue <input type="checkbox"/> Wed <input type="checkbox"/> Thu <input type="checkbox"/> Fri <input type="checkbox"/> Sat
10	<input type="checkbox"/>	00 00	00 00	<input type="checkbox"/> Sun <input type="checkbox"/> Mon <input type="checkbox"/> Tue <input type="checkbox"/> Wed <input type="checkbox"/> Thu <input type="checkbox"/> Fri <input type="checkbox"/> Sat

Holiday Setting

Month	Date
1	1-3, 20
2	15
3	

- Open **Auto Attendant Wizard** and configure the Office hours rule. The rule is set as follows:

- Key 1 for support department - Press 1 for technical support.
- Key 2 for sales department - Press 2 for sales.
- Key 3 for advertisement - Press 3 to listen to new products' introduction.
- Key 0 for receptionist - Press 0 to speak with an operator.

IP PBX >> PBX System

Auto Attendant Wizard - Office Hours

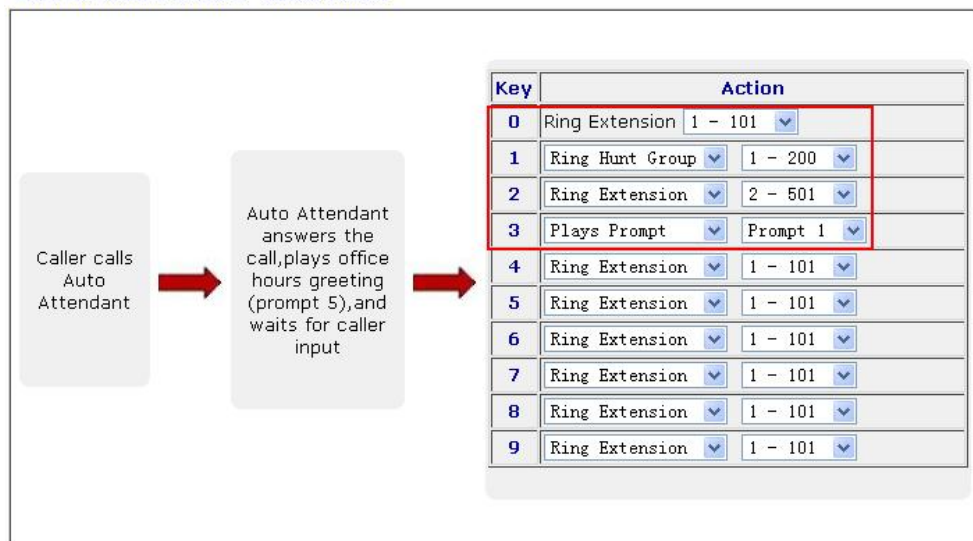

- Press **Next** to configure settings for Non-office hours. Key 0 is designated for Ring Extension and here it is set for receptionist. For other keys, we let the users to listen to new product introduction.

IP PBX >> PBX System

Auto Attendant Wizard - Non-Office Hours

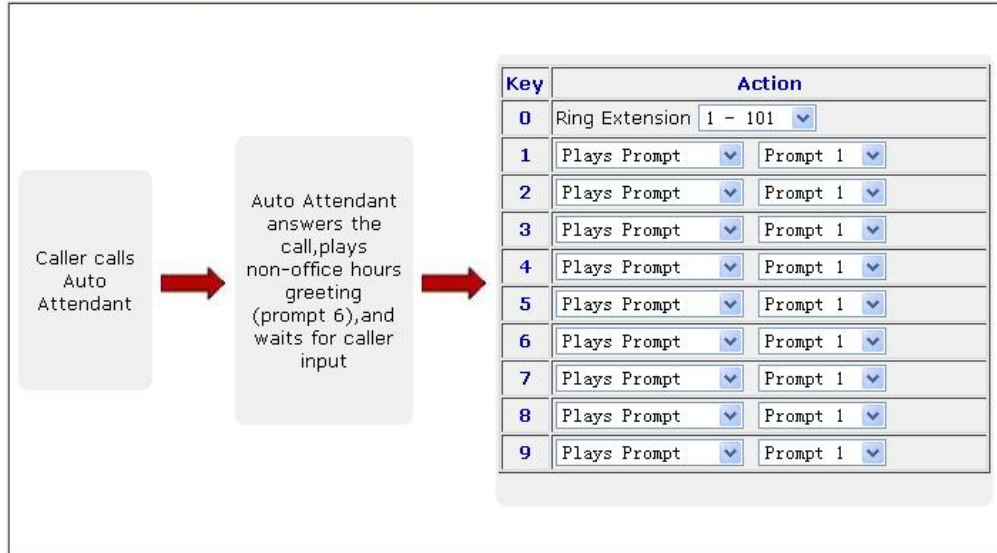

- Then click **OK** to finish the auto attendant wizard.

IP PBX >> PBX System

Auto Attendant Wizard - Record Prompts

Please enter **** and to XXXX access IVR and auto-attendant message menu.

You can record the office hours and non-office hour greetings or other prompts.

Prompt 5 is used as office hours greeting.

Prompt 6 is used as non-office hours greeting.

Prompt 7 is used as specific purposes.

< Back

OK

Cancel

Note: If a caller dials the wrong extension number, VigorIPPBX 2820 will play the greeting once more to let he/she dials the right extension again.

4.13 How to use Voice Mail?

With voice mail, callers can leave messages when you are busy, unable to answer phone calls, or when the IP phone is off-line. Then, at your leisure time, you can listen to the voice messages. This avoids missing important phone calls.

VigorIPPBX 2820 supports voice mail feature. When someone leaves a message to you, you can listen to it from the IP phone. Furthermore, you can have an email sent to you with a .WAV file for the voice message attached to this mail if you want. Later, you can listen to your voice mail by executing the WAV file.

We will take an example to introduce how to configure voice mail through VigorIPPBX 2820. Also we will introduce how to listen to the voice mail.

Suppose we have the following scenario. VigorIPPBX 2820 is deployed in the office. Both Jacky and Graham use IP phones, and connect them to VigorIPPBX 2820 with extension numbers 211 and 101 registered to VigorIPPBX 2820 respectively. Voice mails are both enabled for these two extension numbers. In addition, Graham requires VigorIPPBX 2820 to send an email to him when there is a voice message.

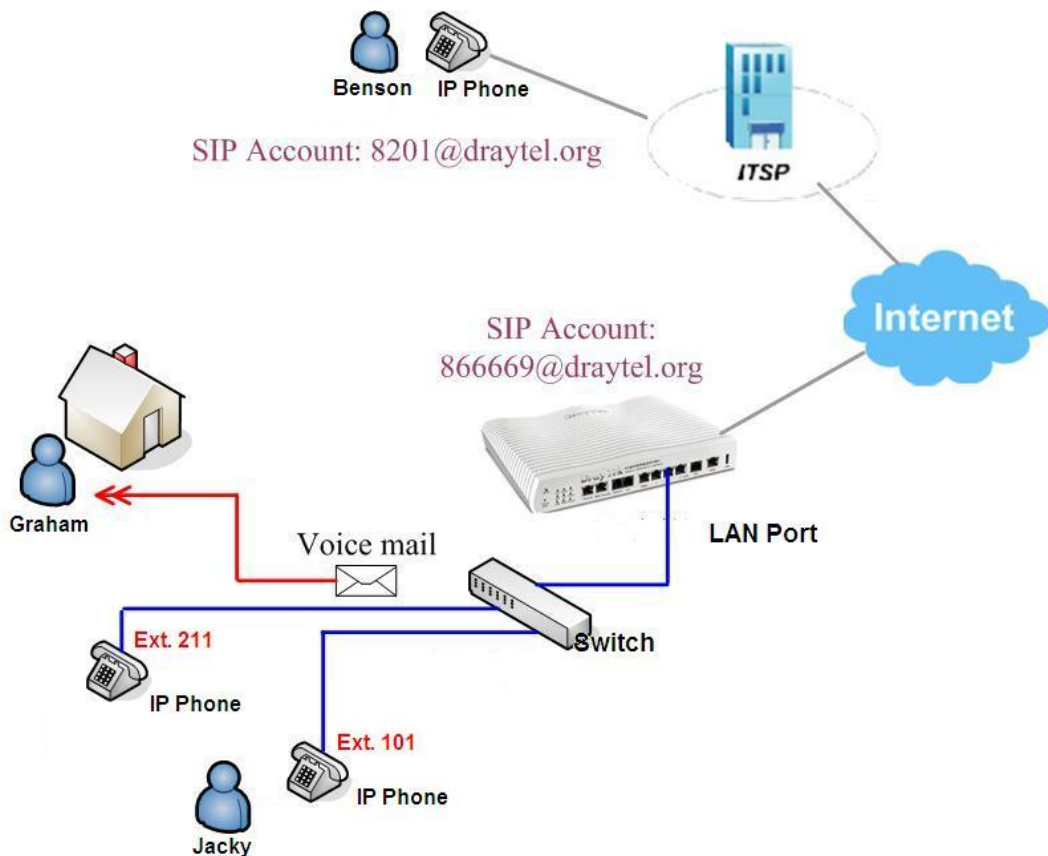

When Graham is busy, unable to answer the phone calls, or when his IP phone is off-line, Benson will be prompted to leave a message. If a message is leaved, it will be saved in VigorIPPBX 2820. An email with the voice message attached will be sent to Graham. Graham can listen to his voice mail either via his IP phone or via his mail client.

When Jacky is busy, unable to answer the phone calls, or when his IP phone is off-line, Benson will be prompted to leave a message. If a message is leaved, it will be saved in VigorIPPBX 2820. However, no email will be sent to Jacky for such voicemail. Jacky can listen to his voicemail only via his IP phone.

Follow steps below to enable voice mail for Graham and Jacky.

1. Open Graham's extension profile. Below shows the explanation of basic configuration. Graham's **Extension Number** is 211. **Display Name** is locally significant for identification. Make sure the **Type** is SIP. Enable **Authentication** and type a **Password** for this extension.
2. Input an **E-mail address** for Graham to receive voice mails.

IP PBX >> Extension Profile

Internal Phone Extension Index 1

Internal Phone Extension Active Enable Disable

Extension Number

Display Name

Type ▼

Authentication

Password

E-mail Address

Voice mail Password

MWI

Notify User who Subscribed Force Notify User

Outgoing Call Use

SIP1 SIP2 SIP3 SIP4 SIP5 SIP6 ISDN2-TE

Answer Mode

No answer after sec then ▼

Busy then ▼

Not on-line ▼

E-mail Address:

Input Graham's email address for receiving voicemail.

Voice mail Password:

If you want to listen the voice mail by using IP phone, you must a voice mail password. This can prevent someone else to listen to your voice message. Only digit characters (0-9) are accepted as voice mail password.

Answer Mode:

Select Voice Mail. When Graham is busy, unable to answer the phone calls, or when his IP phone is off-line, *VigorIPPBX 2820* will ask the caller to leave a message.

3. Open Jacky's extension profile. Below shows the explanation of basic configuration. Jacky's **Extension Number** is 101. **Display Name** is locally significant for identification. Make sure the **Type** is SIP. Enable **Authentication** and type a **Password** for this extension.

4. Input an e-mail address for Jacky to receive voice mails. In this case, no e-mail address is specified.

IP PBX >> Extension Profile

Internal Phone Extension Index 1

Internal Phone Extension Active	<input type="radio"/> Enable <input checked="" type="radio"/> Disable
Extension Number	<input type="text" value="101"/>
Display Name	<input type="text" value="Jacky"/>
Type	<input type="text" value="SIP"/>
<input checked="" type="checkbox"/> Authentication	
Password	<input type="text" value="••••"/>
E-mail Address	<input type="text"/> <input type="button" value="Send a test e-mail"/>
Voice mail Password	<input type="text" value="••••"/>
MWI	<input checked="" type="radio"/> Notify User who Subscribed <input type="radio"/> Force Notify User
Outgoing Call Use	<input checked="" type="checkbox"/> SIP1 <input checked="" type="checkbox"/> SIP2 <input checked="" type="checkbox"/> SIP3 <input checked="" type="checkbox"/> SIP4 <input checked="" type="checkbox"/> SIP5 <input checked="" type="checkbox"/> SIP6 <input checked="" type="checkbox"/> ISDN2-TE
Answer Mode	
No answer after	<input type="text" value="30"/> sec then <input type="text" value="Voice Mail"/>
Busy then	<input type="text" value="Voice Mail"/>
Not on-line	<input type="text" value="Voice Mail"/>

E-mail Address:

Don't input any email address here. Jacky will not receive a voice mail via email.

Voice mail Password:

If you want to listen the voice mail by IP phone, you must setup a voice mail password. This can prevent someone else to listen to your voice message. Only digit characters (0-9) are accepted as voice mail password.

Answer Mode:

Select Voice Mail. When Jacky is busy, unable to answer the phone calls, or when his IP phone is off-line, VigorIPPBX 2820 will ask the caller to leave a message.

Additional Configuration for Voice Mail

Open the **IP PBX >> PBX System >> Voice Mail Configuration** page and setup the system properties of voice mail.

[IP PBX >> PBX System](#)

Voice Mail Configuration

Extension for checking messages	<input type="text" value="888"/>	(20 ~ 65535)
<input checked="" type="checkbox"/> Send Voice Message by Email		
<input type="checkbox"/> Delete Voice Message after Sending Mail		
Day for keeping voice mail	<input type="text" value="3"/>	(1~7)
Maximum messages time	<input type="text" value="30 Sec"/>	
Mail Voice-Mail Setup		
SMTP Server	<input type="text" value="211.---.---.20"/>	
<input checked="" type="checkbox"/> Authentication		
User Name	<input type="text" value="graham"/>	
Password	<input type="password" value="•••••"/>	

Extension for checking message:

If you want to listen to a voice mail, you need to dial the number which is set in the field of Extension for checking messages. The default value is 888. You can change it manually.

Send Voice Message by Email:

Tick it to enable sending voicemail via email.

Delete Voice Message after Sending Mail:

If it is enabled, a voice message will be automatically deleted from VigorIPPBX 2820 after an email containing this message has been sent out successfully. You can't listen to a message from your IP phone after it is deleted from VigorIPPBX 2820.

Day for keeping voice mail:

It means the time for keeping a voice mail in VigorIPPBX 2820. The default value is 3 (days). After the time, this message will be deleted automatically.

Maximum messages time:

The longer the time is, the larger size of a voice message will be. There are three options: 30 seconds, 60 seconds and 90 seconds.

Mail Voice-Mail Setup:

To send a voice mail via email, a SMTP server must be configured. Input the username and password if the SMTP server requires authentication.

Ways to Listen voice messages

Method 1

When there is a voice mail, Graham will receive an email with a WAV file attached. This WAV file records the voice message. By double clicking on the WAV file, Graham can listen to the message leaved by Benson.

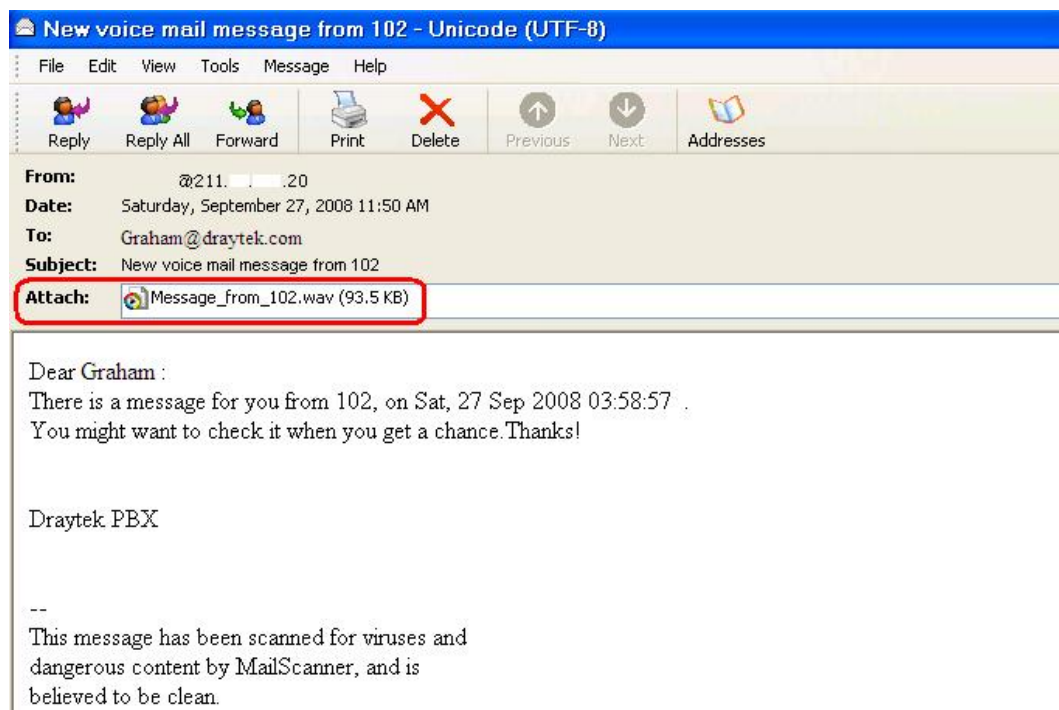

Method 2

Graham can listen to his voice messages via his IP phone as follows:

1. Pick up the IP phone which has registered to VigorIPPBX 2820 with the extension number 211.
2. Dial 888. This number is defined in **IP PBX >> PBX System >> Voice Mail Configuration** page.
3. Enter the Voice mail Password. It is defined in **IPPXB>>Extension Profiles**.
4. A prompt will be played informing if you have any voice messages or not.
5. Press * to play the first message.
6. Press 0 to play the next message.
7. Press # to hang up the call.

For more actions, you may refer to the following flow chart.

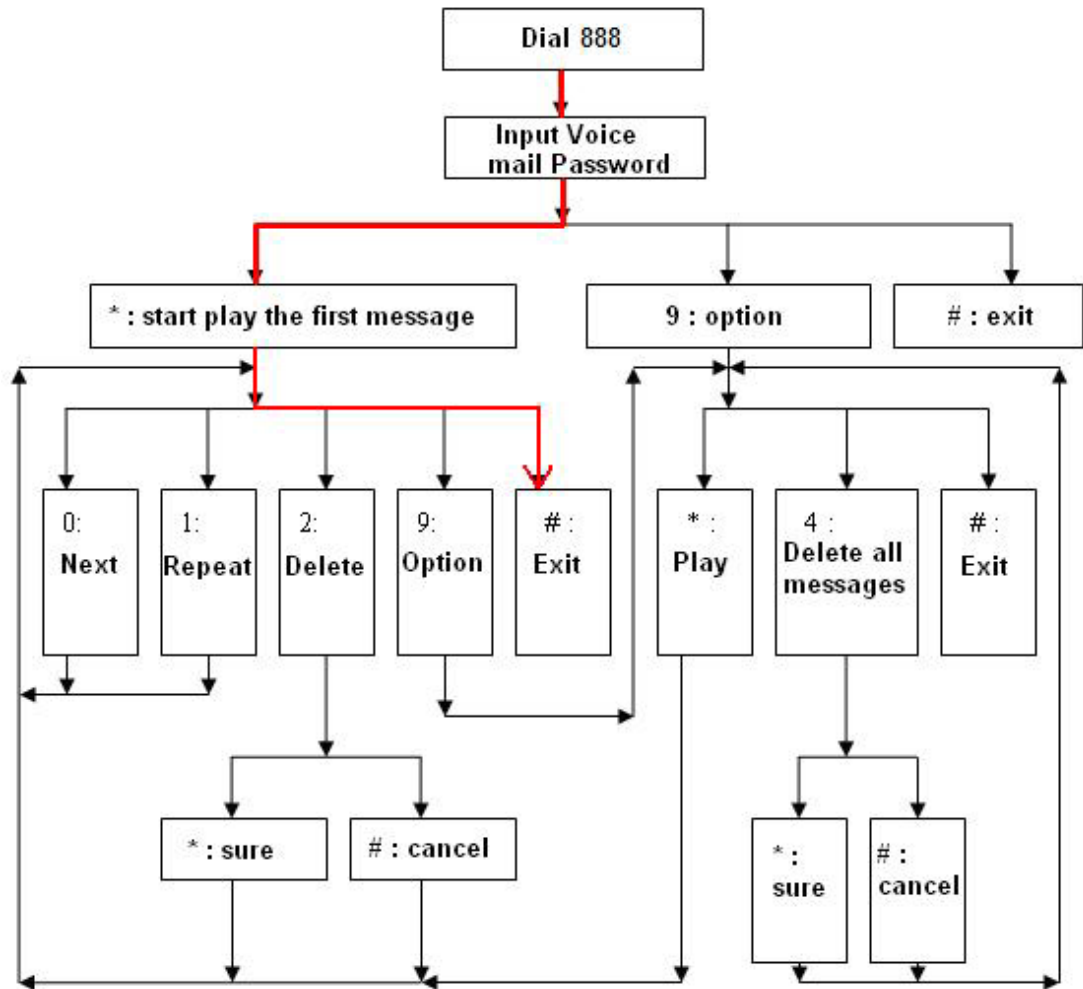

Since Jacky configures to listen to voice messages from IP Phone, no email will be sent to Jacky.

4.14 How to configure and use the MWI on Vigor IPPBX 2820?

MWI is namely Message Waiting Indication. Messaging Waiting Indication is a common feature of telephone networks. It typically involves an audible or visible indication that messages are waiting, such as playing a special dial tone (which in telephone network is called message-waiting dial tone), lighting a light or indicator on the phone, displaying icons or text, or some combination (draft-ietf-sipping-mwi-04.txt).

Vigor IPPBX 2820 supports MWI feature. With this feature, when someone leaves you a voice message, a special tone (MWI tone) will be played while you pick the phone up. This implies that you have a voice message. After listening such special tone, you will hear the normal dial tone. Then you can choose to listen to the voice message or call someone back.

Example for using MWI

Here, we use the following illustration to make an example for using MWI.

Generally, Jacky uses mail client to receive voice mails. But it's not convenient to check voice mail via mail client at all times. Especially there is a possibility that voice mails may be dropped or deleted by an accident due to Antivirus scan. To avoid it, Jacky also uses MWI feature of Vigor IPPBX 2820 to inform himself of missed phone calls.

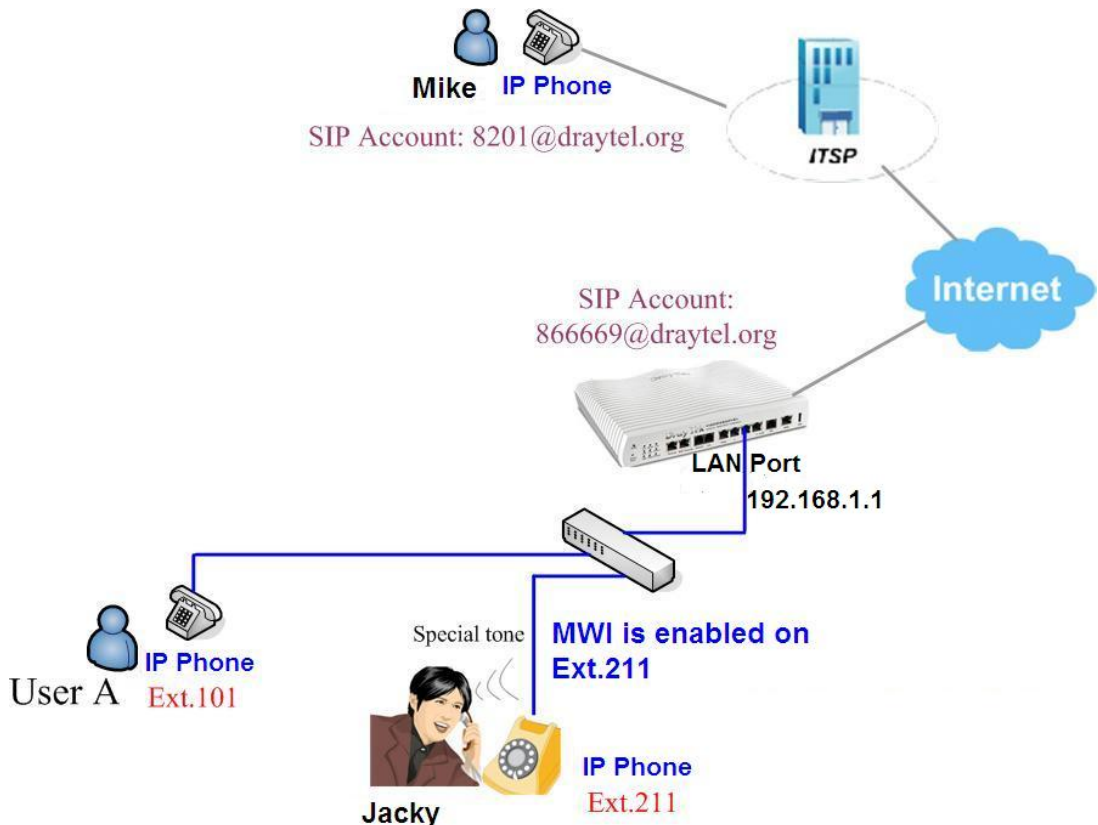

Configure MWI for Jacky's Extension

1. Open the extension profile for Jacky. Below shows the explanation of basic configuration. Jacky's **Extension Number** is 211. **Display Name** is locally significant for identification. Make sure the **Type** is **SIP**. Enable **Authentication** and type a **Password** for this extension. Input an **E-mail address** for Jacky to receive voice mails.

2. Select either **Notify User who Subscribed** or **Force Notify User** for MWI.

IP PBX >> Extension Profile

Internal Phone Extension Index 1

Internal Phone Extension Active	<input type="radio"/> Enable <input checked="" type="radio"/> Disable
Extension Number	<input type="text" value="211"/>
Display Name	<input type="text" value="Jacky"/>
Type	<input type="text" value="SIP"/>
<input checked="" type="checkbox"/> Authentication	
Password	<input type="password" value="••••"/>
E-mail Address	<input type="text" value="jacky@draytek.com"/> <input type="button" value="Send a test e-mail"/>
Voice mail Password	<input type="password" value="••••"/>
MWI	<input checked="" type="radio"/> Notify User who Subscribed <input type="radio"/> Force Notify User
Outgoing Call Use	<input checked="" type="checkbox"/> SIP1 <input checked="" type="checkbox"/> SIP2 <input checked="" type="checkbox"/> SIP3 <input checked="" type="checkbox"/> SIP4 <input checked="" type="checkbox"/> SIP5 <input checked="" type="checkbox"/> SIP6 <input checked="" type="checkbox"/> ISDN2-TE
Answer Mode	
No answer after	<input type="text" value="120"/> sec then <input type="text" value="Keep Ring"/>
Busy then	<input type="text" value="Do Nothing"/>
Not on-line	<input type="text" value="Do Nothing"/>

Voice mail Password:

If you want to listen to the voice mail by phone via VigorIPPBX 2820, you must configure the voice mail password. It can prevent someone else listening to your voice mail. Namely, users need to input the voice mail password before they listen to the voice mail.

Notify User who Subscribed:

Most IP Phones support MWI feature. You can enable or disable it for your requirement. When **Notify User who Subscribed** is selected, VigorIPPBX 2820 will send MWI to the IP phone with MWI enabled. However, if the IP phone does not enable MWI function, VigorIPPBX 2820 will not send MWI to that IP phone.

Force Notify User:

When Force Notify User is selected, VigorIPPBX 2820 automatically sends MWI to the clients when there is voice message no matter the IP phone enables MWI function or not.

Additional Configuration for Voice Mail

Go to the **IP PBX >> PBX System >> Voice Mail Configuration** page and configure the following items.

IP PBX >> PBX System

Voice Mail Configuration

Extension for checking messages	<input type="text" value="888"/>	(20 ~ 65535)
<input checked="" type="checkbox"/> Send Voice Message by Email		
<input type="checkbox"/> Delete Voice Message after Sending Mail		
Day for keeping voice mail	<input type="text" value="3"/>	(1~7)
Maximum messages time	<input type="text" value="30 Sec"/>	
Mail Voice-Mail Setup		
SMTP Server	<input type="text"/>	
<input type="checkbox"/> Authentication		
User Name	<input type="text"/>	
Password	<input type="text"/>	

Extension for checking messages:

If you want to listen to a voice mail, you need to dial the number which is set in the field of Extension for checking messages. The default value is 888. You can change it manually.

Day for keeping voice mail:

It means the time for keeping a voice mail in VigorIPPBX 2820. The default value is 3 (days). After the time, this message will be deleted automatically.

Send Voice Message by Email:

Tick it to enable the voice mail function.

Delete Voice Message after Sending Mail:

If you are using MWI, do not enable such option. No MWI notification will be sent after a voice message is deleted.

Example Explanation

1. Mike calls 866669@iptel.org and dials extension number 211.
2. Jacky is not available at that time.
3. Mike leaves a message to Jacky, then hands up the phone.
4. Jacky is free and picks up his phone.
5. Instead of the normal dial tone, Jacky hears a special tone (MWI tone) which implies that he has a voice message. After listening the special tone, Jacky will hear the normal dial tone.
6. Jacky dials **888** and input the voice mail password to hear his voice message.

4.15 How to register extensions to VigorIPPBX 2820?

VigorIPPBX 2820 supports Software based SIP phones, Hardware based SIP Phones and Analogue phones attached to ATA (Analog Telephone Adapter). In this document we will introduce how to use these clients to register extensions to VigorIPPBX 2820.

Basic Network Connection for VigorIPPBX 2820

In this document we will use the scenario illustrated in the following graphic.

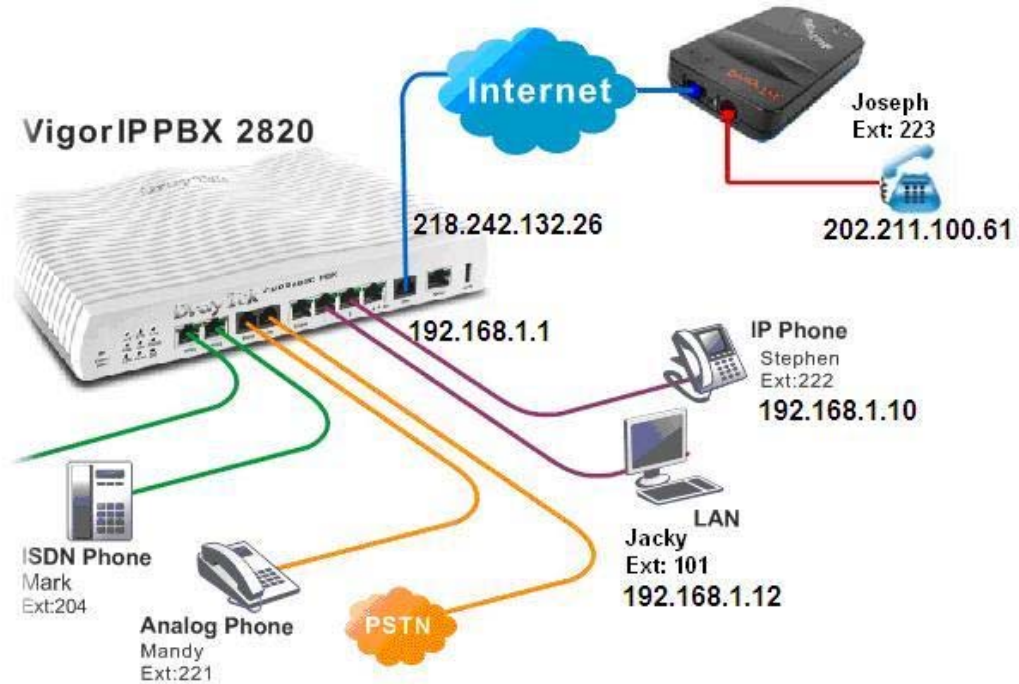

1. VigorIPPBX 2820 acts as an SIP server with WAN IP: 218.242.132.26 and LAN IP: 192.168.1.1.
2. Stephen uses an IP Phone connected/registered to VigorIPPBX 2820 via LAN.
3. Jacky uses the software Phone registered to VigorIPPBX 2820 via LAN.
4. Joseph uses an analogue phone attached to an ATA registered to VigorIPPBX 2820 via WAN.
5. Mandy uses an analog phone connecting to FXS port of VigorIPPBX 2820.
6. Mark uses an ISDN phone connecting to ISDN port of VigorIPPBX 2820.

Setup the extensions on Vigor/IPPBX 2820

1. Enter the **IP PBX >> Extension Profile** setup page and configure the relevant extension profile.

IP PBX >> Extension Profile

Internal Phone Extension Index 1

Internal Phone Extension Active	<input checked="" type="radio"/> Enable <input type="radio"/> Disable
Extension Number	<input type="text" value="101"/>
Display Name	<input type="text" value="Jacky"/>
Type	<input type="text" value="SIP"/>
<input checked="" type="checkbox"/> Authentication	
Password	<input type="password" value="●●●"/>
E-mail Address	<input type="text"/> <input type="button" value="Send a test e-mail"/>
Voice mail Password	<input type="password" value="●●●●"/>
MWI	
<input checked="" type="checkbox"/> Notify User who Subscribed	<input type="radio"/> Force Notify User
Outgoing Call Use	
<input checked="" type="checkbox"/> SIP1 <input checked="" type="checkbox"/> SIP2 <input checked="" type="checkbox"/> SIP3 <input checked="" type="checkbox"/> SIP4 <input checked="" type="checkbox"/> SIP5 <input checked="" type="checkbox"/> SIP6 <input checked="" type="checkbox"/> ISDN2-TE	
Answer Mode	
No answer after	<input type="text" value="5"/> sec then <input type="text" value="Keep Ring"/>
Busy then	<input type="text" value="Do Nothing"/>
Not on-line	<input type="text" value="Do Nothing"/>

2. After finishing the settings, you may have the following table.

IP PBX >> Extension

Internal Phone Extension

Index	Ext.	Name	Email Address	Outgoing Call	Status
1.	101	Jacky		SIP1	v
2.	222	Stephen		SIP1	v
3.	223	Joseph		SIP1	v
4.	204	Mark		SIP1 ISDN2-TE	v
5.	221	Mandy		SIP1	v
6.	---	---		SIP1 SIP2 SIP3 SIP4 SIP5 SIP6 ISDN2-TE	x
7.	---	---		SIP1 SIP2 SIP3 SIP4 SIP5 SIP6 ISDN2-TE	x

Setup the VoIP clients to register extensions

- **Software based IP Phone (e.g. SJphone)**

Jacky is using SJphone, a VoIP softphone, for registering his extension 101 to VigorIPPBX 2820.

Start the **SJphone**. Open the **Options** windows and click the **Profiles** tab. Create a new profile. Make sure the **Profile type** is **Call through SIP Proxy**. Finally, press **OK**.

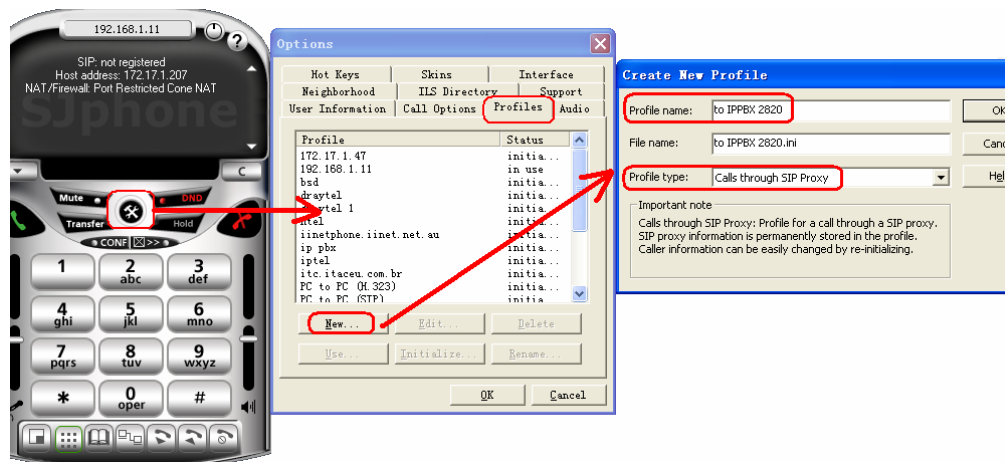

You will get the **Profile Options** window. Open the **SIP Proxy** tab and configure the address of IPPBX. The computer is located in the local network of VigorIPPBX 2820, therefore the LAN IP address (192.168.1.1) of VigorIPPBX 2820 must be input in the **Proxy domain** field. Here we use the default SIP port 5060. Press **OK**.

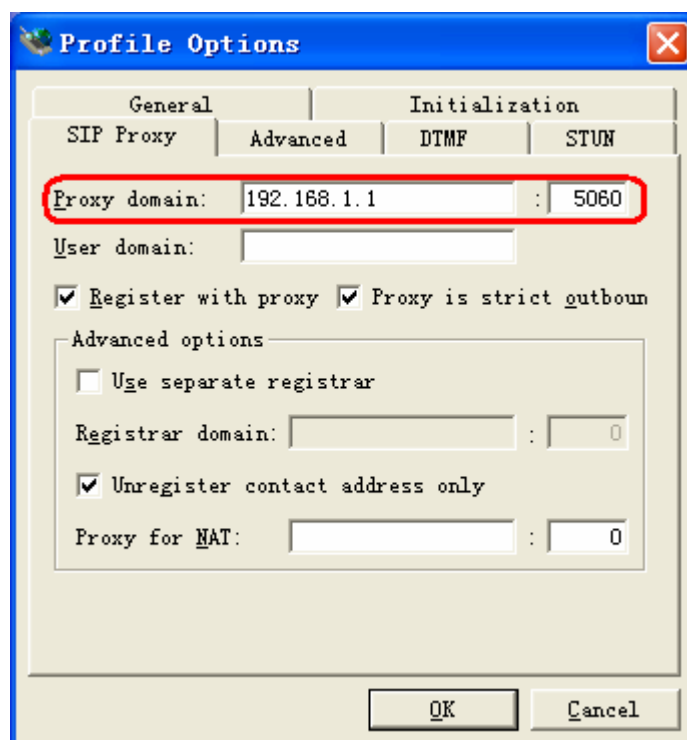

Next, the account setup page pops up. Enter the extension in the **Account** field and its corresponding password in the **Password** field. The password must be the same as set in VigorIPPBX 2820.

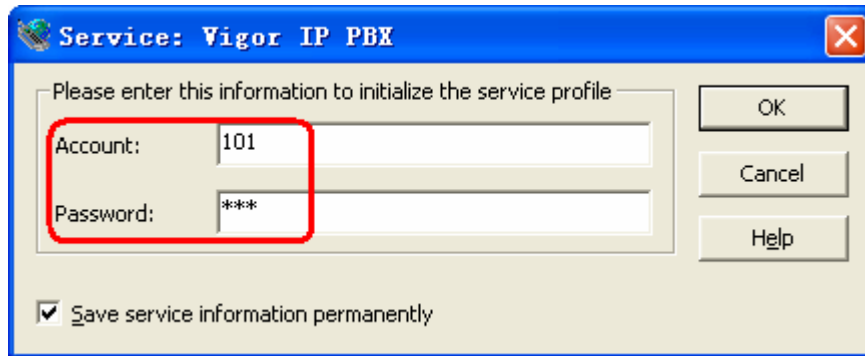

Service: Vigor IP PBX

Please enter this information to initialize the service profile

Account: 101

Password: ****

Save service information permanently

OK

Cancel

Help

- **Hardware based IP Phone (e.g. VigorPhone 350)**

Stephen is using VigorPhone 350, a hard IP telephone, for registering his extension 222 to VigorIPPBX 2820. The VigorPhone 350 is connected behind VigorIPPBX 2820, therefore the LAN IP address (192.168.1.1) must be set as **Registration Server**, **Proxy Server** and **Realm Address**. Enter other settings as figure shown below. The password must be the same as set in VigorIPPBX 2820.



VigorPhone 350
IP Phone

DrayTek

SIP Account Settings

This page allows you to set SIP account for this device.

SIP Account 1

Registration: Enable Disable

Registration ID: 222

Display Name: Stephen

Password: ***

Registration Server: 192.168.1.1

Expire Time: 60

DTMF Type: RFC2833

Authentication Name: 222

Proxy Server: 192.168.1.1

Realm Address: 192.168.1.1

Voice Mail: 888

Ping Before Register: Disable

Send KeepAlive: On Off

MWI: Disable

Overlap dial: Disable

Status: registered

- **Analogue Phone attached to an ATA (e.g. VigorTalk)**

Joseph is using VigorTalk, an analog telephony adapter, for registering his extension 223 to VigorIPPBX 2820. Since he is on the Internet, the WAN IP address (218.242.132.36 in this example) of VigorIPPBX 2820 must be set as Registrar and Proxy addresses. Enter other settings as figure shown below. The password must be the same as set in VigorIPPBX 2820.

Monitor the status of extensions on VigorIPPBX 2820

After configuration, please check the status on VigorIPPBX 2820. If the extension registered successfully on VigorIPPBX 2820, the relevant **Status** will display **Online**.

[IP PBX >> PBX Status](#)

Extension Monitor Refresh Seconds: | [Refresh](#) |

Index	Name	Extension	IP	Status	Peer ID
1	Jacky	101	192.168.1.12	Online	
2	Stephen	222	192.168.1.10	Online	
3	Joseph	223	202.211.100.61	Online	
4	Mark	204		Offline	
5	Mandy	221	192.168.1.1	Online	
6	---	---		Offline	
7	---	---		Offline	
8	---	---		Offline	
9	---	---		Offline	
10	---	---		Offline	

[<< 1-10](#) | [11-20](#) | [21-30](#) | [31-40](#) | [41-50](#) | [51-52 >>](#)
[Next >>](#)

4.16 How to configure and use ISDN-S0 MSN on Vigor IPPBX 2820

Why need ISDN-S0 MSN?

The ISDN S0 port of Vigor2820VS/Vigor IPPBX 2820 can connect with two ISDN phones or connect to an ISDN PBX with multiple ISDN devices connected.

For there are so many ISDN devices, we can set different MSN numbers for mapping different ISDN devices.

Below shows an example of connection structure for your reference.

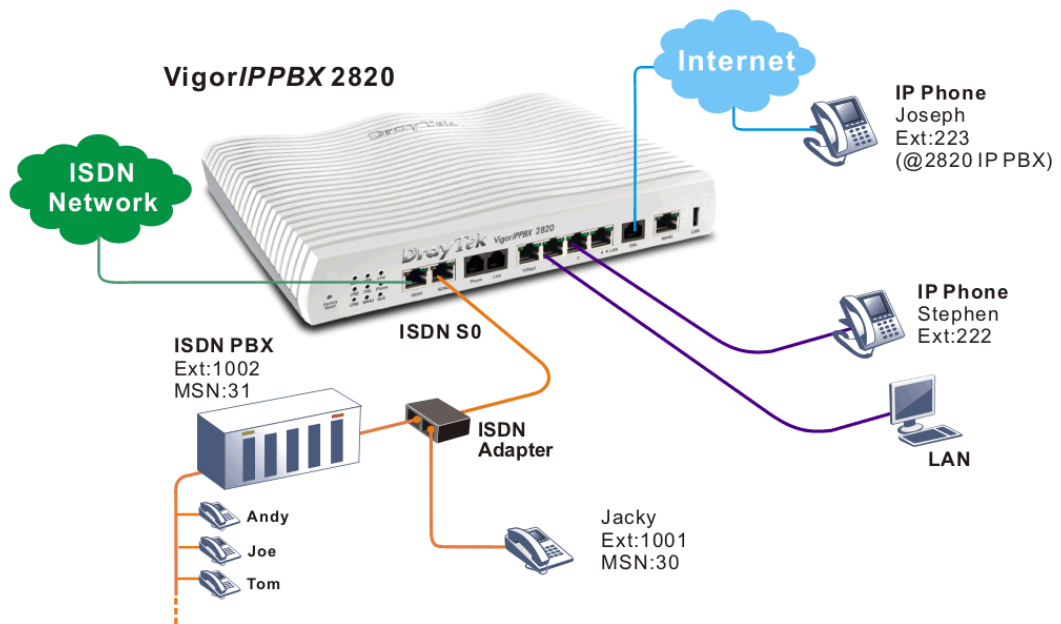

Note: ISDN Phone adapter must connect to Vigor Router's ISDN S0 port, otherwise Vigor Router will not provide power/isdn signal to the S0 port.

How to configure ISDN S0 MSN?

1. Access into the web configuration page of VigorIPPBX 2820.
2. Open **IPPBX>>Extension** and click one of the index links to set extension profile.
3. Select **ISDN1-S0** and relevant MSN (from 30-39) for the Type setting.

It means When someone calls ext:**1001**, VigorIPPBX 2820 will forward such call to the device connected to VigorIPPBX 2820 ISDN S0 port with MSN number “30”.

IP PBX >> Extension Profile

Internal Phone Extension Index 1

Internal Phone Extension Active	<input checked="" type="radio"/> Enable <input type="radio"/> Disable
Extension Number	<input type="text" value="1001"/>
Display Name	<input type="text" value="1001"/>
Type	<input type="text" value="ISDN1-S0"/> <input type="text" value="30"/>
<input checked="" type="checkbox"/> Authentication	
Password	<input type="password" value="••••"/>
E-mail Address	<input type="text"/> <input type="button" value="Send a test e-mail"/>
Voice mail Password	<input type="password" value="••••"/>
MWI	
<input checked="" type="radio"/> Notify User who Subscribed	<input type="radio"/> Force Notify User
Outgoing Call Use	
<input checked="" type="checkbox"/> SIP1	<input checked="" type="checkbox"/> SIP2
<input checked="" type="checkbox"/> SIP3	<input checked="" type="checkbox"/> SIP4
<input checked="" type="checkbox"/> SIP5	<input checked="" type="checkbox"/> SIP6
<input checked="" type="checkbox"/> ISDN2-TE	
Answer Mode	
No answer after	<input type="text" value="120"/> sec then <input type="text" value="Keep Ring"/>
Busy then	<input type="text" value="Do Nothing"/>
Not on-line	<input type="text" value="Do Nothing"/>

IP PBX >> Extension

Internal Phone Extension

Index	Ext.	Name	Email Address	Outgoing Call	Status
1.	1001	Jacky		SIP1	v
2.	1002	Tom		SIP1	v
3.	1003	Joe		SIP1	v

The MSN number for the connected ISDN device also must be set with 30.

How to dial out through the device connected ISDN port

To dial out an SIP call, please dial the trunk number for SIP Trunk (e.g., dial 001 if you want to use iptel SIP account) first and then dial the SIP number of the peer.

IP PBX >> SIP Trunk List

SIP Trunk List Refresh Seconds: 5 | Refresh |

Index	Profile Name	Domain/Realm	Proxy	Account Number/Name	Trunk Number	Status
1.	iptel	iptel.org	iptel.org	88888123	001	-
2.	draytel	draytel.org	draytel.org	8114345	002	-
3.					003	-
4.					004	-
5.					005	-
6.					006	-

R: Success registered on SIP server
-: Fail to register on SIP server

To dial out an ISDN call, please dial the extension number (e.g., 904) for ISDN TE port first and then the ISDN number of the peer.

IP PBX >> ISDN Trunk

ISDN Trunk

ISDN 1 Trunk Number	<input type="text" value="903"/>
ISDN 2 Trunk Number	<input type="text" value="904"/>
Office hours answer mode	<input type="text" value="Auto Attendant"/>
Non-Office hours answer mode	<input type="text" value="Auto Attendant"/>
<input type="checkbox"/> ISDN Trunk Auto Hunt	<input type="text" value="666"/>

OK

Cancel

4.17 Creating an Account for MyVigor

The website of MyVigor (a server located on <http://myvigor.draytek.com>) provides several useful services (such as Anti-Spam, Web Content Filter, Anti-Intrusion, and etc.) to filter the web pages for protecting your system.

To access into MyVigor for getting more information, please create an account for MyVigor.

4.17.1 Creating an Account via Vigor Router

1. Click **CSM>> Web Content Filter Profile**. The following page will appear.

The screenshot shows the 'Web-Filter License' page. At the top right is an 'Activate' link. Below it, the status is '[Status:Not Activated]'. There are two sections for server setup: 'Setup Query Server' and 'Setup Test Server', both with 'auto-selected' in a dropdown menu and a 'Find more' link. Below these is a 'Web Content Filter Profile Table' with a 'Set to Factory Default' link. The table has four columns: Profile, Name, Profile, and Name. The first row shows profile '1.' with name 'Default', and the second row shows profile '2.' with name '7'.

Profile	Name	Profile	Name
1.	Default	5.	
2.		6.	
3.		7.	

Or

Click **System Maintenance>>Activation** to open the following page.

The screenshot shows the 'System Maintenance >> Activation' page. At the top right is an 'Activate via interface' dropdown menu set to 'WAN 1'. Below it is the 'Web-Filter License' section with an 'Activate' link and a status of '[Status:Not Activated]'. A text area labeled 'Authentication Message' contains the text: 'WebFilter, service not activate 2000-01-01 00:00:17'.

2. Click the **Activate** link. A login page for MyVigor web site will pop up automatically.

**This service is available for MyVigor member only. Please login to access MyVigor.
If you are not one of the members of MyVigor, please create an account first.**

The screenshot shows the MyVigor login page. It has an orange header with 'LOGIN'. There are three input fields: 'UserName', 'Password', and 'Auth Code'. To the right of the 'Auth Code' field is a CAPTCHA image showing 'AYi GXZ'. Below the CAPTCHA is a link 'If you cannot read the word, click here'. There is a 'Forget password?' link and a 'Login' button. At the bottom, there is a link 'Don't have a MyVigor Account ? Create an account now'.

If you are having difficulty logging in, contact our customer service.
Customer Service : (886) 3 597 2727 or
email to :webmaster@draytek.com

3. Click the link of **Create an account now**.

4. Check to confirm that you accept the Agreement and click **Accept**.

Register

Create an account - Please enter personal profile.

1 Agreement

2 Personal Information

3 Preferences

4 Completion

MyVigor Agreement

1. Agreement

Draytek provides MyVigor(myvigor.draytek.com) service according to this agreement. When you use MyVigor service, it means that you have read, understand and agree to accept the items listed in this agreement. Draytek can modify or change the content of the items without any reasons. It is suggested for you to notice the medications or changes at any time. If you still use MyVigor service after knowing the modifications and changes of this service, it means you have read, understand and agree to accept the modifications and changes. If you do not agree the content of this agreement, please stop using MyVigor service.

2. Registration

To use this service, you have to agree the following conditions:

(a) Provide your complete and correct information according to the registration steps of this service.

(b) If you provide any incorrect or fake information here, DrayTek has the right to pause or terminate your service.

I have read and understand the above Agreement. (Use the scroll bar to view the entire agreement)

<< Back Accept >>

5. Type your personal information in this page and then click **Continue**.

Register

Create an account - Please enter personal profile. (Fields marked by (*) are required)

1 Agreement

2 Personal Information

3 Preferences

4 Completion

Account Information

UserName:* Mary Check Account

(3 ~ 20 characters)

Password:* ●●●●

(4 ~ 20 characters : Do not set the same as the username.)

Confirm Password:* ●●●●

Personal Information

First Name:* Mary

Last Name:* Ted

Company Name: Tech Ltd.

Email Address:* mary_ted@tech.com

Tel: 0 -

Country:* SWITZERLAND

Career:* Supervisor

Please note that a valid E-mail address is required to receive the Subscription Code. You will need this code to activate your account.

<< Back Continue >>

6. Choose proper selection for your computer and click **Continue**.

Register

Create an account - Please enter personal profile.

1 Agreement

2 Personal Information

3 Preferences

4 Completion

How did you find out about this website? Internet

What kind of anti-virus do you use? AntiVir

I would like to subscribe to the MyVigor e-letter.

I would like to receive DrayTek product news.

Please select the mail server for receiving the verification mail. Global Server

<< Back Continue >>

- Now you have created an account successfully. Click START.

Register

Create an account - Please enter personal profile.

1 Agreement

2 Personal Information

3 Preferences

4 Completion

Completion

A confirmation email has been sent to **mary_ted@tech.com**
Please click on the activation link in the email
to activate your account

START

- Check to see the confirmation *email* with the title of **New Account Confirmation Letter from myvigor.draytek.com**.

***** This is an automated message from myvigor.draytek.com. *****

Thank you (**Mary**) for creating an account.

Please click on the activation link below to activate your account

Link : [Activate my Account](#)

- Click the **Activate my Account** link to enable the account that you created. The following screen will be shown to verify the register process is finished. Please click **Login**.

Register

Search for this site GO

Register Confirm

Thank for your register in VigorPro Web Site
The Register process is completed

Close Login

10. When you see the following page, please type in the account and password (that you just created) in the fields of **UserName** and **Password**.

This service is available for MyVigor member only. Please login to access MyVigor. If you are not one of the members of MyVigor, please create an account first.

LOGIN

UserName :

Password :

Auth Code : **T4he1C**

If you cannot read the word, [click here](#)

[Forget password?](#)

Don't have a MyVigor Account ? [Create an account now](#)

If you are having difficulty logging in, contact our customer service.
Customer Service : (888) 3 597 2727 or
email to :webmaster@draytek.com

11. Now, click **Login**. Your account has been activated. You can access into MyVigor server to activate the service (e.g., WCF) that you want.

4.17.2 Creating an Account via MyVigor Web Site

1. Access into <http://myvigor.draytek.com>. Find the line of **Not registered yet?**. Then, click the link **Click here!** to access into next page.

DrayTek MyVigor Customer Survey

Home Search GO

MyVigor for you

MyVigor website replaces the VigorPro site as DrayTek's portal site for the latest products and services in network security, including Anti-Virus, Anti-Spam, Web Content Filter... etc. The products and functions that are supported in this site include:

VigorPro Unified Security Firewall series:

- Activation of Commtouch™ GlobalView Web Content Filter license key
- Activation of DT Anti-Virus license key
- Activation of Kaspersky Anti-Virus license key
- Activation of Commtouch™ Anti-Spam license key and membership

Vigor routers (for models that support Commtouch™)

- Activation of Commtouch™ GlobalView Web Content Filter license key

The MyVigor website contains a trial version of Commtouch™ GlobalView Web Content Filter, which allows the users to set filters to block out undesirable web pages in the Internet jungle.

More customer-oriented services are planned for MyVigor site for the near future.

Please use IE 5.0 or above (resolution 1024 * 768) for best display. © DrayTek Corp.

Customer Survey

Login

UserName

Password

AuthCode

If you can't read the AuthCode, [click here](#)

[Forget password?](#)

Not registered yet ? [Click here!](#)

2. Check to confirm that you accept the Agreement and click **Accept**.

Register

Create an account - Please enter personal profile.

1 Agreement

2 Personal Information

3 Preferences

4 Completion

MyVigor Agreement

1. Agreement

Draytek provides MyVigor(myvigor.draytek.com) service according to this agreement. When you use MyVigor service, it means that you have read, understand and agree to accept the items listed in this agreement. Draytek can modify or change the content of the items without any reasons. It is suggested for you to notice the medications or changes at any time. If you still use MyVigor service after knowing the modifications and changes of this service, it means you have read, understand and agree to accept the modifications and changes. If you do not agree the content of this agreement, please stop using MyVigor service.

2. Registration

To use this service, you have to agree the following conditions:

(a) Provide your complete and correct information according to the registration steps of this service.

(b) If you provide any incorrect or fake information here, DrayTek has the right to pause or terminate your account.

I have read and understand the above Agreement. (Use the scroll bar to view the entire agreement)

<< Back Accept >>

3. Type your personal information in this page and then click **Continue**.

Register

Create an account - Please enter personal profile. (Fields marked by (*) are required)

1 Agreement

2 Personal Information

3 Preferences

4 Completion

Account Information

UserName:* Mary Check Account

(3 ~ 20 characters)

Password:* ●●●●

(4 ~ 20 characters : Do not set the same as the username.)

Confirm Password:* ●●●●

Personal Information

First Name:* Mary

Last Name:* Ted

Company Name: Tech Ltd.

Email Address:* mary_ted@tech.com

Please note that a valid E-mail address is required to receive the Subscription Code. You will need this code to activate your account.

Tel: 0 -

Country:* SWITZERLAND

Career:* Supervisor

<< Back Continue >>

4. Choose proper selection for your computer and click **Continue**.

Register

Create an account - Please enter personal profile.

1 Agreement

2 Personal Information

3 Preferences

4 Completion

How did you find out about this website? Internet

What kind of anti-virus do you use? AntiVir

I would like to subscribe to the MyVigor e-letter.

I would like to receive DrayTek product news.

Please select the mail server for receiving the verification mail. Global Server

<< Back Continue >>

5. Now you have created an account successfully. Click START.

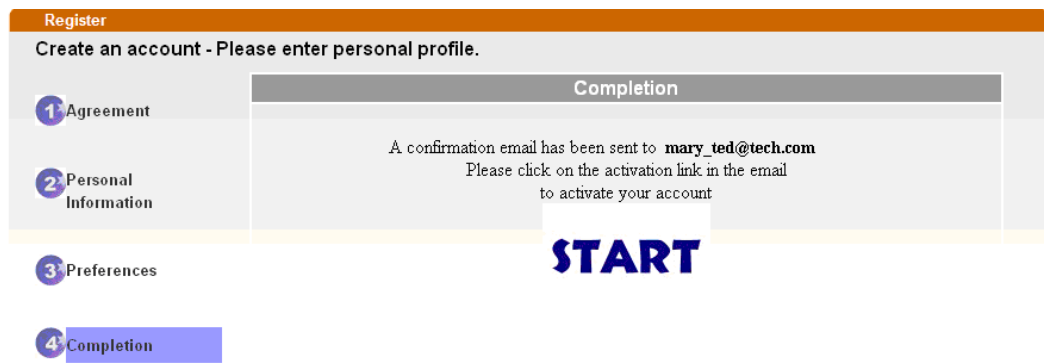

6. Check to see the confirmation *email* with the title of **New Account Confirmation Letter from myvigor.draytek.com**.

***** This is an automated message from myvigor.draytek.com.*****

Thank you (**Mary**) for creating an account.

Please click on the activation link below to activate your account

Link : [Activate my Account](#)

7. Click the **Activate my Account** link to enable the account that you created. The following screen will be shown to verify the register process is finished. Please click **Login**.

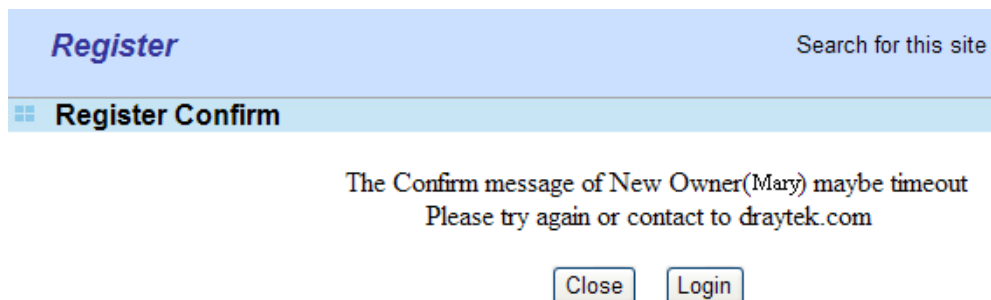

8. When you see the following page, please type in the account and password (that you just created) in the fields of **UserName** and **Password**. Then type the code in the box of Auth Code according to the value displayed on the right side of it.

This service is available for MyVigor member only. Please login to access MyVigor.
If you are not one of the members of MyVigor, please create an account first.

LOGIN

UserName :

Password :

Auth Code : **T4he1C**

If you cannot read the word, [click here](#)

[Forget password?](#)

Don't have a MyVigor Account ? [Create an account now](#)

If you are having difficulty logging in, contact our customer service.
Customer Service : (888) 3 597 2727 or
email to : webmaster@draytek.com

Now, click **Login**. Your account has been activated. You can access into MyVigor server to activate the service (e.g., WCF) that you want

4.18 How to use mOTP feature through the router and iPhone

Draytek provides one-time password support for build-in **PPTP** and **L2TP** connection. All Draytek customers can use one-time password to authenticate VPN connections.

To generate a one-time password, the user has to enter his personal PIN code into the device. The authentication is based on two factors: the token device and the PIN code.

There are many one-time password clients for the iPhone, such as mOTP, iOTP or CitrusOTP. Here we will introduce mOTP (mobile OneTimePasswords), which may be downloaded from the following links.

<http://appshopper.com/utilities/motp-mobile-onetimepasswords>

<http://iphone.wareseeker.com/motp-mobile-onetimepasswords.app/42f14b91b3>

Note: The above downloading links may be invalid in the future. Searching “iPhone Mobile-OTP” with Google, you may find more resources.

For the user, please perform the steps listed below for one time.

1. Suppose that mOTP has been successfully installed on your iPhone (we will not introduce the installation here). Open it and press the button **Generate Secret** to initialize your secret key. Don't do this if there already is a secret key existed, otherwise it will re-initialize your secret key.

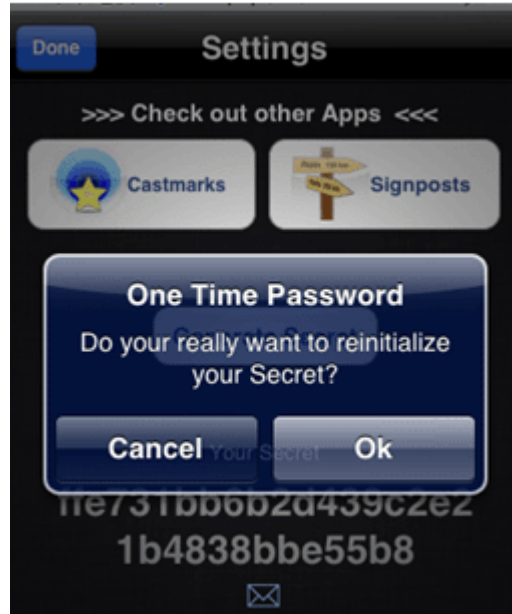

2. Shake your iPhone to generate a random secret key.

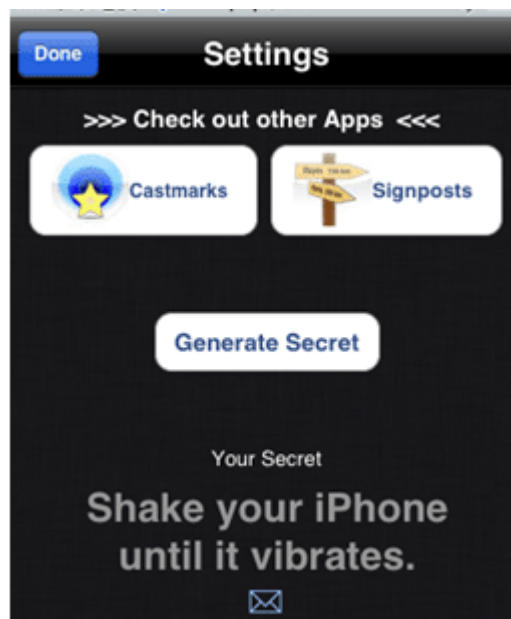

- Keep this secret key down and report it to your administrator. In this example the secret key is `e759bb6f0e94c7ab4fe689ebf00c5202`.

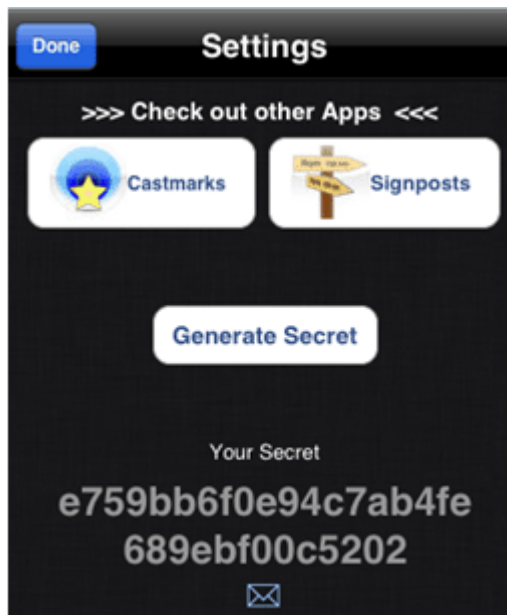

- Make sure the system time of your iPhone is correct. Once the Secret Key is generated and your system time is synced, mOTP is ready to generate one time password.

For the administrator, please do the following:

- Setup a remote-dial-in VPN profile and check **Enable Mobile One-Time Passwords (mOTP)**. Setup a username. Setup a PIN code (e.g., `1111`) which can be 4 to 7 numbers. Enter the secret key (e.g., `e759bb6f0e94c7ab4fe689ebf00c5202`) which is generated and got from the end user.

VPN and Remote Access >> Remote Dial-in User

Index No. 1

User account and Authentication

Enable this account

Idle Timeout second(s)

Allowed Dial-In Type

PPTP

IPsec Tunnel

L2TP with IPsec Policy

Specify Remote Node

Remote Client IP or Peer ISDN Number

or Peer ID

Username

Password

Enable Mobile One-Time Passwords(mOTP)

PIN Code

Secret

IKE Authentication Method

Pre-Shared Key

IKE Pre-Shared Key

Digital Signature(X.509)

Note: Both the PIN Code and Secret will be hidden with '*' after you press the **OK** button.

- Make sure the system time on Draytek router is correct.
- Inform the end user of the Username and PIN code.

Below steps are for end user to dial the VPN connection. Each time you start a new VPN connection, you must perform the following steps to generate a valid password.

1. Open mOTP. Enter the PIN code. In this example it is 1111. Then press “Generate Password”.

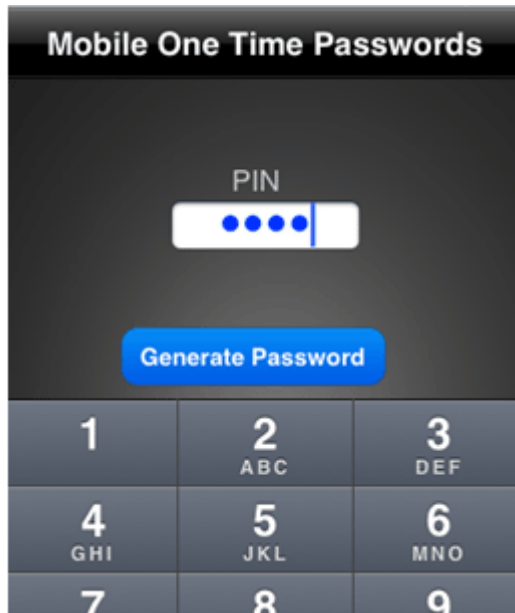

Note: Each time you enter the PIN code you will get a different password.

2. Here the password is *3dcecd*.

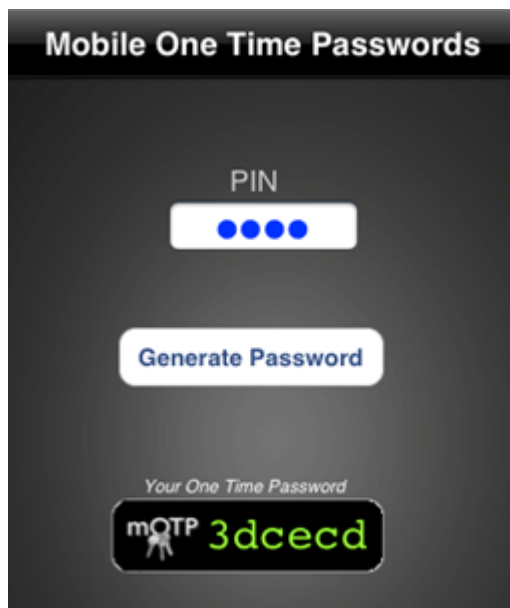

3. Enter the password on your VPN client and start the connection as soon as possible. The password is valid only for 1 minute.

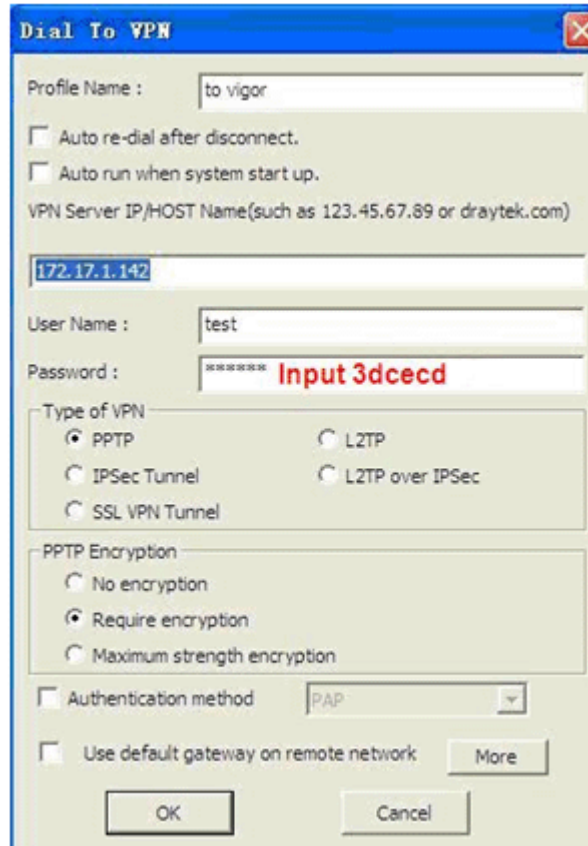

4. When the connection is dropped, you must generate a new password then redial the connection.

Summary:

1. End user generates a secret key and reports it to the administrator.
2. Administrator enters this secret key in a teleworker profile.
3. Administrator setups a username and PIN code and provides them to the end user.
4. End user uses the PIN code to generate a password.

Chapter 5: Reference - Advanced Web Configuration

After finished basic configuration of the router, you can access Internet with ease. For the people who want to adjust more setting for suiting his/her request, please refer to this chapter for getting detailed information about the advanced configuration of this router. As for other examples of application, please refer to chapter 4.

5.1 WAN

Quick Start Wizard offers user an easy method to quick setup the connection mode for the router. Moreover, if you want to adjust more settings for different WAN modes, please go to **WAN** group and click the **Internet Access** link.

5.1.1 Basics of Internet Protocol (IP) Network

IP means Internet Protocol. Every device in an IP-based Network including routers, print server, and host PCs, needs an IP address to identify its location on the network. To avoid address conflicts, IP addresses are publicly registered with the Network Information Centre (NIC). Having a unique IP address is mandatory for those devices participated in the public network but not in the private TCP/IP local area networks (LANs), such as host PCs under the management of a router since they do not need to be accessed by the public. Hence, the NIC has reserved certain addresses that will never be registered publicly. These are known as *private* IP addresses, and are listed in the following ranges:

From 10.0.0.0 to 10.255.255.255

From 172.16.0.0 to 172.31.255.255

From 192.168.0.0 to 192.168.255.255

What are Public IP Address and Private IP Address

As the router plays a role to manage and further protect its LAN, it interconnects groups of host PCs. Each of them has a private IP address assigned by the built-in DHCP server of the Vigor router. The router itself will also use the default **private IP** address: 192.168.1.1 to communicate with the local hosts. Meanwhile, Vigor router will communicate with other network devices through a **public IP** address. When the data flow passing through, the Network Address Translation (NAT) function of the router will dedicate to translate public/private addresses, and the packets will be delivered to the correct host PC in the local area network. Thus, all the host PCs can share a common Internet connection.

Get Your Public IP Address from ISP

In ADSL deployment, the PPP (Point to Point)-style authentication and authorization is required for bridging customer premises equipment (CPE). Point to Point Protocol over Ethernet (PPPoE) connects a network of hosts via an access device to a remote access concentrator or aggregation concentrator. This implementation provides users with significant ease of use. Meanwhile it provides access control, billing, and type of service according to user requirement.

When a router begins to connect to your ISP, a serial of discovery process will occur to ask for a connection. Then a session will be created. Your user ID and password is authenticated

via **PAP** or **CHAP** with **RADIUS** authentication system. And your IP address, DNS server, and other related information will usually be assigned by your ISP.

5.1.2 Network Connection by 3G USB Modem

For 3G mobile communication through Access Point is popular more and more, VigorIPPBX 2820 adds the function of 3G network connection for such purpose. By connecting 3G USB Modem to the USB port of VigorIPPBX 2820, it can support HSDPA/UMTS/EDGE/GPRS/GSM and the future 3G standard (HSUPA, etc). VigorIPPBX 2820 with 3G USB Modem allows you to receive 3G signals at any place such as your car or certain location holding outdoor activity and share the bandwidth for using by more people. Users can use four LAN ports on the router to access Internet. Also, they can access Internet via 802.11n wireless function of VigorIPPBX 2820n, and enjoy the powerful firewall, bandwidth management, VPN, VoIP features of VigorIPPBX 2820 series.



After connecting into the router, 3G USB Modem will be regarded as the second WAN port. However, the original Ethernet WAN1 still can be used and Load-Balance can be done in the router. Besides, 3G USB Modem in WAN2 also can be used as backup device. Therefore, when WAN1 is not available, the router will use 3.5G for supporting automatically. The supported 3G USB Modem will be listed on Draytek web site. Please visit www.draytek.com for more detailed information.

Below shows the menu items for Internet Access.

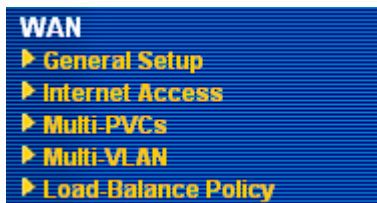

5.1.3 General Setup

This section will introduce some general settings of Internet and explain the connection modes for WAN1 and WAN2 in details.

This router supports dual WAN function. It allows users to access Internet and combine the bandwidth of the dual WAN to speed up the transmission through the network. Each WAN port can connect to different ISPs, Even if the ISPs use different technology to provide telecommunication service (such as DSL, Cable modem, etc.). If any connection problem occurred on one of the ISP connections, all the traffic will be guided and switched to the normal communication port for proper operation. Please configure WAN1 and WAN2 settings.

This webpage allows you to set general setup for WAN1 and WAN2 respectively.

Note: In default, WAN1 and WAN2 are enabled.

WAN >> General Setup

General Setup

WAN1	WAN2
Enable: <input type="checkbox"/> Yes <input checked="" type="checkbox"/> No	Enable: <input type="checkbox"/> Yes <input checked="" type="checkbox"/> No
Display Name: <input type="text"/>	Display Name: <input type="text"/>
Physical Mode: ADSL	Physical Mode: Ethernet
Physical Type: Auto negotiation	Physical Type: Auto negotiation
Load Balance Mode: Auto Weight	Load Balance Mode: Auto Weight
Line Speed(Kbps): DownLink <input type="text"/>	Line Speed(Kbps): DownLink <input type="text"/>
UpLink <input type="text"/>	UpLink <input type="text"/>
Active Mode: Always On	Active Mode: Always On
Active on demand: <input type="radio"/> WAN2 Fail <input checked="" type="radio"/> WAN2 Upload speed exceed <input type="text"/> Kbps WAN2 Download speed exceed <input type="text"/> Kbps	Active on demand: <input type="radio"/> WAN1 Fail <input checked="" type="radio"/> WAN1 Upload speed exceed <input type="text"/> Kbps WAN1 Download speed exceed <input type="text"/> Kbps

OK

Enable

Choose **Yes** to invoke the settings for this WAN interface. Choose **No** to disable the settings for this WAN interface.

Display Name

Type the description for the WAN1/WAN2 interface.

Physical Mode

For WAN1, the physical connection is done through ADSL port; yet the physical connection for WAN2 is done through an Ethernet port (P1) or USB port. You cannot change it.

Physical Mode:

Ethernet
3G USB Modem

To use 3G network connection through 3G USB Modem, choose **3G USB Modem** as the physical mode in **WAN2**. Next, go to **WAN >> Internet Access**. 3G USB Modem is available for WAN2. You can enable **PPP** as the access mode and complete further configuration.

WAN >> Internet Access

WAN 2	
PPP Client Mode	<input type="radio"/> Enable <input checked="" type="radio"/> Disable
SIM PIN code	<input type="text"/>
Modem Initial String	AT&FE0V1X1&D2&C1S0=0 (Default: AT&FE0V1X1&D2&C1S0=0)
APN Name	<input type="text"/> <input type="button" value="Apply"/>
Modem Dial String	ATDT*99# (Default: ATDT*99#)
PPP Username	<input type="text"/> (Optional)
PPP Password	<input type="text"/> (Optional)
Index(1-15) in Schedule Setup:	=> <input type="text"/> , <input type="text"/> , <input type="text"/> , <input type="text"/>

OK Cancel Default

Physical Type

This setting is available for WAN2 only. You can change the physical type for WAN2 or choose **Auto negotiation** for determined by the system.

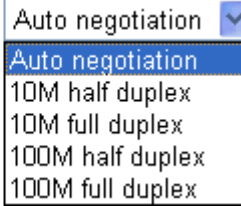
Physical Type: 

Load Balance Mode

If you know the practical bandwidth for your WAN interface, please choose the setting of **According to Line Speed**. Otherwise, please choose **Auto Weigh** to let the router reach the best load balance.

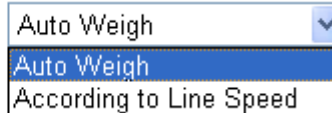
Load Balance Mode: 

Line Speed

If you choose **According to Line Speed** as the **Load Balance Mode**, please type the line speed for downloading and uploading through WAN1/WAN2. The unit is kbps.

Active Mode

Choose **Always On** to make the WAN connection (WAN1/WAN2) being activated always; or choose **Active on demand** to make the WAN connection (WAN1/WAN2) activated if it is necessary.

Active Mode: 

If you choose Active on demand, the Idle Timeout will be available for you to set for PPPoE and PPTP access modes in the **Details Page** of **WAN>>Internet Access**. In addition, there are three selections for you to choose for different purposes.

WAN2 Fail – It means the connection for WAN1 will be activated when WAN2 is failed.

WAN2 Upload speed exceed XX kbps – It means the connection for WAN1 will be activated when WAN2 Upload speed exceed certain value that you set in this box for 15 seconds.

WAN2 Download speed exceed XX kbps– It means the connection for WAN1 will be activated when WAN2 Download speed exceed certain value that you set in this box for 15 seconds.

WAN1 Fail – It means the connection for WAN2 will be activated when WAN1 is failed.

WAN1 Upload speed exceed XX kbps – It means the connection for WAN2 will be activated when WAN1 Upload speed exceed certain value that you set in this box for 15 seconds.

WAN1 Download speed exceed XX kbps– It means the connection for WAN2 will be activated when WAN1 Download speed exceed certain value that you set in this box

for 15 seconds.

5.1.4 Internet Access

For the router supports dual WAN function, the users can set different WAN settings (for WAN1/WAN2) for Internet Access. Due to different physical mode for WAN1 and WAN2, the Access Mode for these two connections also varies slightly.

WAN >> Internet Access

Internet Access

Index	Display Name	Physical Mode	Config Information
WAN1		ADSL	Channel:1, VPI:0, VCI:33, Protocol:PPPoE/LLC/SNAP, Modulation:Multimode, Dynamic IP
WAN2		Ethernet	IP Address:172.16.3.229, Subnet Mask:255.255.0.0, Gateway IP:172.16.3.4

Index It shows the WAN modes that this router supports. WAN1 is the default WAN interface for accessing into the Internet. WAN2 is the optional WAN interface for accessing into the Internet when WAN 1 is inactive for some reason.

Display Name It shows the name of the WAN1/WAN2 that entered in general setup.

Physical Mode It shows the physical port for WAN1/WAN2.

Config Information It shows brief configuration information for WAN1/WAN2 interface.

WAN1 and WAN2 support different protocols. WAN1 supports PPPoE/PPPoA and MPoA. WAN2 supports PPPoE, Static or Dynamic IP and PPTP. According to physical connection of your router, please choose suitable WAN interface link to set detailed information.

PPPoE/PPPoA for WAN1

To use **PPPoE/PPPoA** as the accessing protocol of the Internet, select **PPPoE/PPPoA** mode. The following web page will appear.

[WAN >> Internet Access](#)

WAN 1

PPPoE / PPPoA | **MPoA (RFC1483/2684)**

Enable Disable

DSL Modem Settings

Multi-PVC channel: Channel 1

VPI: 8

VCI: 35

Encapsulating Type: VC MUX

Protocol: PPPoA

Modulation: Multimode

PPPoE Pass-through

For Wired LAN

For Wireless LAN

ISDN Dial Backup Setup

Dial Backup Mode: None

WAN Connection Detection

Mode: ARP Detect

Ping IP:

TTL:

ISP Access Setup

Username:

Password:

PPP Authentication: PAP or CHAP

Idle Timeout: -1 second(s)

IP Address From ISP

Fixed IP: Yes No (Dynamic IP)

Fixed IP Address:

Default MAC Address

Specify a MAC Address

MAC Address:

Index(1-15) in [Schedule](#) Setup:

=> , , ,

Enable/Disable

Click **Enable** for activating this function. If you click **Disable**, this function will be closed and all the settings that you adjusted in this page will be invalid.

DSL Modem Settings

Set up the DSL parameters required by your ISP. These are vital for building DSL connection to your ISP.

Multi-PVC channel - The selections displayed here are determined by the page of **Internet Access – Multi PVCs**. **Select M-PVCs Channel** means no selection will be chosen.

VPI - Type in the value provided by ISP.

VCI - Type in the value provided by ISP.

Encapsulating Type - Drop down the list to choose the type provided by ISP.

Protocol - Drop down the list to choose the one provided by ISP.

If you have already used **Quick Start Wizard** to set the protocol, then it is not necessary for you to change any settings in this group.

Modulation – Default setting is Multimode. Choose the one that fits the requirement of your router.

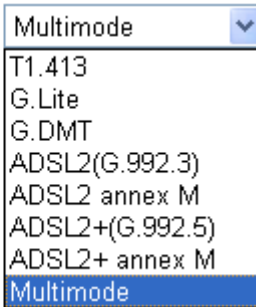
Modulation 

Multimode
T1.413
G.Lite
G.DMT
ADSL2(G.992.3)
ADSL2 annex M
ADSL2+(G.992.5)
ADSL2+ annex M
Multimode

PPPoE Pass-through

The router offers PPPoE dial-up connection. Besides, you also can establish the PPPoE connection directly from local clients to your ISP via the Vigor router. When PPPoA protocol is selected, the PPPoE package transmitted by PC will be transformed into PPPoA package and sent to WAN server. Thus, the PC can access Internet through such direction.

For Wired LAN – If you check this box, PCs on the same network can use another set of PPPoE session (different with the Host PC) to access into Internet.

For Wireless LAN – If you check this box, PCs on the same wireless network can use another set of PPPoE session (different with the Host PC) to access into Internet.

ISDN Dial Backup Setup

This setting is available for the routers supporting ISDN function only. Before utilizing the ISDN dial backup feature, you must create a dial backup profile first. Please click **ISDN > Dialing to a Single ISP** to create the backup profile.

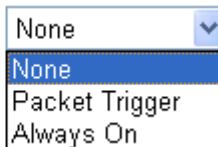
Dial Backup Mode 

None
None
Packet Trigger
Always On

Note: This feature is available for ISDN 2 port only.

None - Disable the backup function.

Packet Trigger -The backup line is not on until a packet from a local host triggers the router to establish a connection.

Always On - If the broadband connection is no longer available, the backup line will be activated automatically and always on until the broadband connection is restored. We recommend you to enable this feature if you host a web server for your customers' access.

WAN Connection Detection

Such function allows you to verify whether network connection is alive or not through ARP Detect or Ping Detect.

Mode – Choose **ARP Detect** or **Ping Detect** for the system to execute for WAN detection.

Ping IP – If you choose Ping Detect as detection mode, you have to type IP address in this field for pinging.

TTL (Time to Live) – Displays value for your reference. TTL

value is set by telnet command.

ISP Access Setup

Enter your allocated username, password and authentication parameters according to the information provided by your ISP. If you want to connect to Internet all the time, you can check **Always On**.

Username – Type in the username provided by ISP in this field.

Password – Type in the password provided by ISP in this field.

PPP Authentication – Select **PAP only** or **PAP or CHAP** for PPP.

Idle Timeout – Set the timeout for breaking down the Internet after passing through the time without any action. This setting is active only when the **Active on demand** option for Active Mode is selected in **WAN>> General Setup** page.

IP Address From ISP

Usually ISP dynamically assigns IP address to you each time you connect to it and request. In some case, your ISP provides service to always assign you the same IP address whenever you request. In this case, you can fill in this IP address in the Fixed IP field. Please contact your ISP before you want to use this function.

WAN IP Alias - If you have multiple public IP addresses and would like to utilize them on the WAN interface, please use WAN IP Alias. You can set up to 8 public IP addresses other than the current one you are using. Notice that this setting is available for WAN1 only. Type the additional WAN IP address and check the Enable box. Then click OK to exit the dialog.

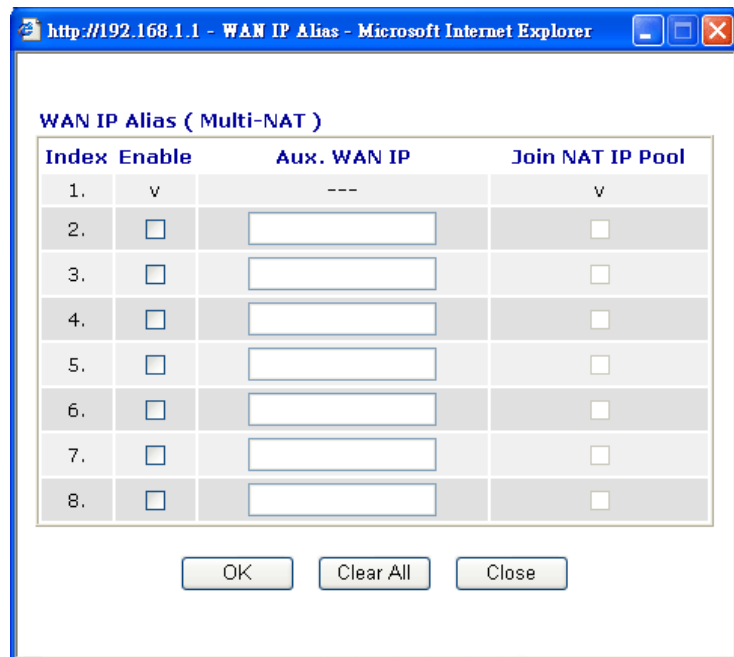

Fixed IP – Click **Yes** to use this function and type in a fixed IP address in the box of **Fixed IP Address**.

Default MAC Address – You can use **Default MAC Address** or specify another MAC address by typing on the boxes of MAC Address for the router.

Specify a MAC Address – Type the MAC address for the router manually.

Index (1-15) in Schedule Setup - You can type in four sets of time schedule for your request. All the schedules can be set previously in **Applications >> Schedule** web page and you can use the number that you have set in that web page.

After finishing all the settings here, please click **OK** to activate them.

MPoA for WAN1

MPoA is a specification that enables ATM services to be integrated with existing LANs, which use either Ethernet, token-ring or TCP/IP protocols. The goal of MPoA is to allow different LANs to send packets to each other via an ATM backbone.

To use **MPoA** as the accessing protocol of the Internet, select **MPoA** mode. The following web page will appear.

[WAN >> Internet Access](#)

WAN 1

PPPoE / PPPoA | **MPoA (RFC1483/2684)**

Enable Disable

DSL Modem Settings

Multi-PVC channel: Channel 2

Encapsulation: 1483 Bridged IP LLC

VPI: 0

VCI: 88

Modulation: Multimode

ISDN Dial Backup Setup

Dial Backup Mode: None

WAN Connection Detection

Mode: ARP Detect

Ping IP:

TTL:

RIP Protocol

Enable RIP

Bridge Mode

Enable Bridge Mode

WAN IP Network Settings WAN IP Alias

Obtain an IP address automatically

Router Name: *

Domain Name: *

* : Required for some ISPs

Specify an IP address

IP Address:

Subnet Mask:

Gateway IP Address:

Default MAC Address

Specify a MAC Address

MAC Address: 00 . 50 . 7F . 84 . E7 . D1

DNS Server IP Address

Primary IP Address:

Secondary IP Address:

OK Cancel

DSL Modem Settings

Set up the DSL parameters required by your ISP. These are vital for building DSL connection to your ISP.

Multi-PVC channel - The selections displayed here are

determined by the page of **Internet Access – Multi PVCs**. **Select M-PVCs Channel** means no selection will be chosen.

Encapsulating Type - Drop down the list to choose the type provided by ISP.

VPI - Type in the value provided by ISP.

VCI - Type in the value provided by ISP.

Modulation –Default setting is Multimode. Choose the one that fits the requirement of your router.

Modulation

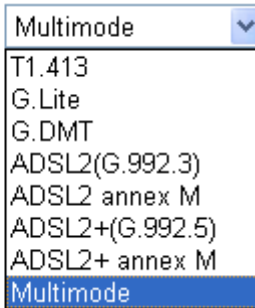

ISDN Dial Backup Setup

This setting is available for the routers supporting ISDN function only. Before utilizing the ISDN dial backup feature, you must create a dial backup profile first. Please click **ISDN > Dialing to a Single ISP** to create the backup profile.

Dial Backup Mode

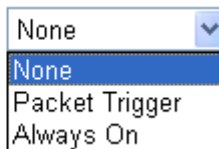

Note: This feature is available for ISDN 2 port only.

None - Disable the backup function.

Packet Trigger -The backup line is not on until a packet from a local host triggers the router to establish a connection.

Always On - If the broadband connection is no longer available, the backup line will be activated automatically and always on until the broadband connection is restored. We recommend you to enable this feature if you host a web server for your customers' access.

WAN Connection Detection

Such function allows you to verify whether network connection is alive or not through ARP Detect or Ping Detect.

Mode – Choose **ARP Detect** or **Ping Detect** for the system to execute for WAN detection.

Ping IP – If you choose Ping Detect as detection mode, you have to type IP address in this field for pinging.

TTL (Time to Live) – Displays value for your reference. TTL value is set by telnet command.

RIP Protocol

Routing Information Protocol is abbreviated as RIP (RFC1058) specifying how routers exchange routing tables information. Click **Enable RIP** for activating this function.

Bridge Mode

If you choose **Bridged IP** as the protocol, you can check this box to invoke the function. The router will work as a bridge modem.

WAN IP Network Settings

This group allows you to obtain an IP address automatically and allows you type in IP address manually.

Obtain an IP address automatically – Click this button to obtain the IP address automatically.

Router Name – Type in the router name provided by ISP.

Domain Name – Type in the domain name that you have assigned.

Specify an IP address – Click this radio button to specify some data.

WAN IP Alias - If you have multiple public IP addresses and would like to utilize them on the WAN interface, please use WAN IP Alias. You can set up to 8 public IP addresses other than the current one you are using. Notice that this setting is available for WAN1 only. Type the additional WAN IP address and check the Enable box. Then click **OK** to exit the dialog.

Index	Enable	Aux. WAN IP	Join NAT IP Pool
1.	<input checked="" type="checkbox"/>	---	<input checked="" type="checkbox"/>
2.	<input type="checkbox"/>	<input type="text"/>	<input type="checkbox"/>
3.	<input type="checkbox"/>	<input type="text"/>	<input type="checkbox"/>
4.	<input type="checkbox"/>	<input type="text"/>	<input type="checkbox"/>
5.	<input type="checkbox"/>	<input type="text"/>	<input type="checkbox"/>
6.	<input type="checkbox"/>	<input type="text"/>	<input type="checkbox"/>
7.	<input type="checkbox"/>	<input type="text"/>	<input type="checkbox"/>
8.	<input type="checkbox"/>	<input type="text"/>	<input type="checkbox"/>

OK Clear All Close

IP Address – Type in the private IP address.

Subnet Mask – Type in the subnet mask.

Gateway IP Address – Type in gateway IP address.

Default MAC Address - Type in MAC address for the router. You can use **Default MAC Address** or specify another MAC address for your necessity.

MAC Address – Type in the MAC address for the router manually.

DNS Server IP Address

Type in the primary IP address for the router. If necessary, type in secondary IP address for necessity in the future.

After finishing all the settings here, please click **OK** to activate them.

PPPoE for WAN2

To use **PPPoE** as the accessing protocol of the Internet, select **PPPoE** mode. The following web page will appear.

[WAN >> Internet Access](#)

The screenshot shows the 'WAN 2' configuration page with the 'PPPoE' tab selected. At the top, there are three tabs: 'PPPoE', 'Static or Dynamic IP', and 'PPTP'. Below the tabs, there are radio buttons for 'Enable' (selected) and 'Disable'. The page is divided into several sections: 'ISP Access Setup' with fields for Username, Password, and Index(1-15) in Schedule Setup; 'ISDN Dial Backup Setup' with a Dial Backup Mode dropdown set to 'None'; 'WAN Connection Detection' with Mode set to 'ARP Detect' and fields for Ping IP and TTL; 'PPP/MP Setup' with PPP Authentication set to 'PAP or CHAP' and Idle Timeout set to '-1' second(s); 'IP Address Assignment Method (IPCP)' with a 'WAN IP Alias' button and Fixed IP set to 'No (Dynamic IP)'; and 'MAC Address' section with 'Default MAC Address' selected and a MAC Address field showing '00 . 50 . 7F . 94 . E7 . D2'. At the bottom, there are 'OK' and 'Cancel' buttons.

Enable/Disable

Click **Enable** for activating this function. If you click **Disable**, this function will be closed and all the settings that you adjusted in this page will be invalid.

ISP Access Setup

Enter your allocated username, password and authentication parameters according to the information provided by your ISP. If you want to connect to Internet all the time, you can check **Always On**.

Username – Type in the username provided by ISP in this field.

Password – Type in the password provided by ISP in this field.

Index (1-15) in Schedule Setup - You can type in four sets of time schedule for your request. All the schedules can be set previously in **Application – Schedule** web page and you can use the number that you have set in that web page.

ISDN Dial Backup Setup

This setting is available for the routers supporting ISDN function only. Before utilizing the ISDN dial backup feature, you must create a dial backup profile first. Please click **ISDN > Dialing to a Single ISP** to create the backup profile.

Dial Backup Mode

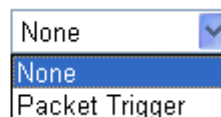

Note: This feature is available for ISDN 2 port only.

None - Disable the backup function.

Packet Trigger -The backup line is not on until a packet from a local host triggers the router to establish a connection.

WAN Connection Detection

Such function allows you to verify whether network connection is alive or not through ARP Detect or Ping Detect.

Mode – Choose **ARP Detect** or **Ping Detect** for the system to execute for WAN detection.

Ping IP – If you choose Ping Detect as detection mode, you have to type IP address in this field for pinging.

TTL (Time to Live) – Displays value for your reference. TTL value is set by telnet command.

PPP/MP Setup

PPP Authentication – Select **PAP only** or **PAP or CHAP** for PPP.

Idle Timeout – Set the timeout for breaking down the Internet after passing through the time without any action. This setting is active only when the **Active on demand** option for Active Mode is selected in **WAN>> General Setup** page.

IP Address Assignment Method (IPCP)

Usually ISP dynamically assigns IP address to you each time you connect to it and request. In some case, your ISP provides service to always assign you the same IP address whenever you request. In this case, you can fill in this IP address in the Fixed IP field. Please contact your ISP before you want to use this function.

WAN IP Alias - If you have multiple public IP addresses and would like to utilize them on the WAN interface, please use WAN IP Alias. You can set up to 8 public IP addresses other than the current one you are using. Notice that this setting is available for WAN1 only. Type the additional WAN IP address and check the Enable box. Then click OK to exit the dialog.

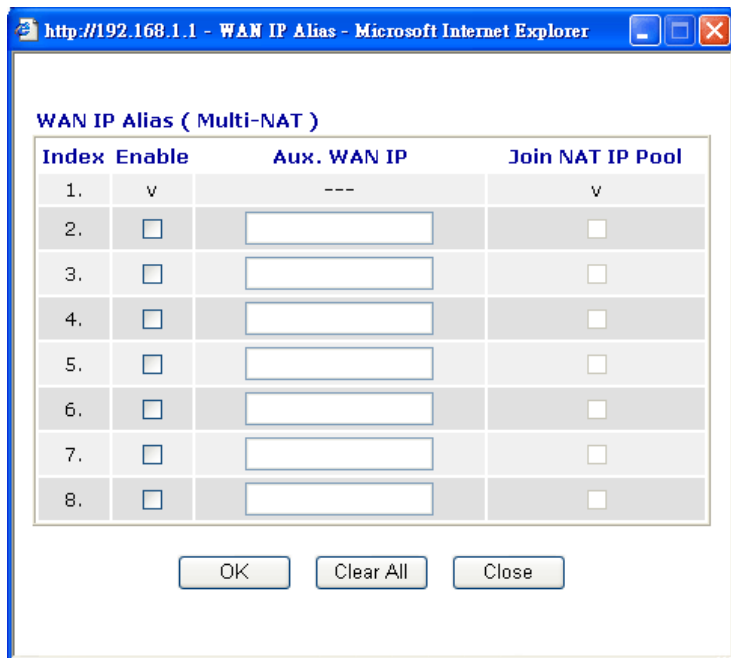

Fixed IP – Click **Yes** to use this function and type in a fixed IP address in the box of **Fixed IP Address**.

Fixed IP Address -Type a fixed IP address.

Default MAC Address – You can use **Default MAC Address** or specify another MAC address by typing on the boxes of MAC Address for the router.

Specify a MAC Address – Type the MAC address for the router manually.

After finishing all the settings here, please click **OK** to activate them.

Static or Dynamic IP for WAN2

For static IP mode, you usually receive a fixed public IP address or a public subnet, namely multiple public IP addresses from your DSL or Cable ISP service providers. In most cases, a Cable service provider will offer a fixed public IP, while a DSL service provider will offer a public subnet. If you have a public subnet, you could assign an IP address or many IP address to the WAN interface.

To use static or dynamic IP as the accessing protocol of the Internet, select **Static or Dynamic IP** mode. The following web page will appear.

WAN >> Internet Access

WAN 2

Static or Dynamic IP

Enable Disable

ISDN Dial Backup Setup
Dial Backup Mode:

Keep WAN Connection
 Enable PING to keep alive
PING to the IP:
PING Interval: minute(s)

WAN Connection Detection
Mode:
Ping IP:
TTL:

RIP Protocol
 Enable RIP

WAN IP Network Settings

Obtain an IP address automatically
Router Name: *
Domain Name: *
* : Required for some ISPs

Specify an IP address
IP Address:
Subnet Mask:
Gateway IP Address:

Default MAC Address
 Specify a MAC Address
MAC Address:

DNS Server IP Address
Primary IP Address:
Secondary IP Address:

Enable/ Disable

Click **Enable** for activating this function. If you click **Disable**, this function will be closed and all the settings that you adjusted in this page will be invalid.

ISDN Dial Backup Setup

This setting is available for the routers supporting ISDN function only. Before utilizing the ISDN dial backup feature, you must create a dial backup profile first. Please click **ISDN > Dialing to a Single ISP** to create the backup profile.

Dial Backup Mode

- None
- Packet Trigger
- Always On

Note: This feature is available for ISDN 2 port only.

None - Disable the backup function.

Packet Trigger -The backup line is not on until a packet from a local host triggers the router to establish a connection.

Always On - If the broadband connection is no longer available, the backup line will be activated automatically and always on until the broadband connection is restored. We recommend you to enable this feature if you host a web server for your customers' access.

Keep WAN Connection

Normally, this function is designed for Dynamic IP environments because some ISPs will drop connections if there is no traffic within certain periods of time. Check **Enable PING to keep alive** box to activate this function.

PING to the IP - If you enable the PING function, please specify the IP address for the system to PING it for keeping alive.

PING Interval - Enter the interval for the system to execute the PING operation.

WAN Connection Detection

Such function allows you to verify whether network connection is alive or not through ARP Detect or Ping Detect.

Mode – Choose **Always On**, **ARP Detect** or **Ping Detect** for the system to execute for WAN detection.

Ping IP – If you choose Ping Detect as detection mode, you have to type IP address in this field for pinging.

TTL (Time to Live) – Displays value for your reference. TTL value is set by telnet command.

RIP Protocol

Routing Information Protocol is abbreviated as RIP (RFC1058) specifying how routers exchange routing tables information. Click **Enable RIP** for activating this function.

WAN IP Network Settings

This group allows you to obtain an IP address automatically and allows you type in IP address manually.

WAN IP Alias - If you have multiple public IP addresses and would like to utilize them on the WAN interface, please use WAN IP Alias. You can set up to 8 public IP addresses other than the current one you are using. Notice that this setting is available for WAN1 only. Type the additional WAN IP address and check the Enable box. Then click OK to exit the dialog.

Index	Enable	Aux. WAN IP	Join NAT IP Pool
1.	v	---	v
2.	<input type="checkbox"/>	<input type="text"/>	<input type="checkbox"/>
3.	<input type="checkbox"/>	<input type="text"/>	<input type="checkbox"/>
4.	<input type="checkbox"/>	<input type="text"/>	<input type="checkbox"/>
5.	<input type="checkbox"/>	<input type="text"/>	<input type="checkbox"/>
6.	<input type="checkbox"/>	<input type="text"/>	<input type="checkbox"/>
7.	<input type="checkbox"/>	<input type="text"/>	<input type="checkbox"/>
8.	<input type="checkbox"/>	<input type="text"/>	<input type="checkbox"/>

OK Clear All Close

Obtain an IP address automatically – Click this button to obtain the IP address automatically if you want to use **Dynamic IP** mode.

Router Name: Type in the router name provided by ISP.

Domain Name: Type in the domain name that you have assigned.

Specify an IP address – Click this radio button to specify some data if you want to use **Static IP** mode.

IP Address: Type the IP address.

Subnet Mask: Type the subnet mask.

Gateway IP Address: Type the gateway IP address.

Default MAC Address: Click this radio button to use default MAC address for the router.

Specify a MAC Address: Some Cable service providers specify a specific MAC address for access authentication. In such cases you need to click the **Specify a MAC Address** and enter the MAC address in the MAC Address field.

DNS Server IP Address

Type in the primary IP address for the router if you want to use **Static IP** mode. If necessary, type in secondary IP address for necessity in the future.

PPTP/L2TP for WAN2

To use **PPTP/L2TP** as the accessing protocol of the Internet, select **PPTP/L2TP** mode. The following web page will appear.

WAN >> Internet Access

WAN 2

PPPoE	Static or Dynamic IP	PPTP/L2TP
<input type="radio"/> Enable PPTP <input type="radio"/> Enable L2TP <input checked="" type="radio"/> Disable		
Server Address <input type="text"/>		
Specify Gateway IP Address <input type="text" value="192.168.5.1"/>		
ISP Access Setup		
Username <input type="text"/>		
Password <input type="text"/>		
Index(1-15) in Schedule Setup: => <input type="text"/> , <input type="text"/> , <input type="text"/> , <input type="text"/>		
ISDN Dial Backup Setup		
Dial Backup Mode <input type="text" value="None"/>		
PPP Setup		
PPP Authentication <input type="text" value="PAP or CHAP"/>		
Idle Timeout <input type="text" value="-1"/> second(s)		
IP Address Assignment Method (IPCP)		
<input type="button" value="WAN IP Alias"/>		
Fixed IP: <input type="radio"/> Yes <input checked="" type="radio"/> No (Dynamic IP)		
Fixed IP Address <input type="text"/>		
WAN IP Network Settings		
<input type="radio"/> Obtain an IP address automatically		
<input checked="" type="radio"/> Specify an IP address		
IP Address <input type="text" value="192.168.5.10"/>		
Subnet Mask <input type="text" value="255.255.255.0"/>		

Enable PPTP/Enable L2TP

Click **Enable PPTP/Enable L2TP** for activating this function.

Disable

If you click **Disable**, this function will be closed and all the settings that you adjusted in this page will be invalid.

Server Address

Specify the IP address of the PPTP/L2TP server.

Specify Gateway IP Address

Specify the gateway IP address for the server.

ISP Access Setup

Username -Type in the username provided by ISP in this field.

Password -Type in the password provided by ISP in this field.

Index (1-15) in Schedule Setup - You can type in four sets of time schedule for your request. All the schedules can be set previously in **Application >>Schedule** web page and you can use the number that you have set in that web page.

ISDN Dial Backup Setup

This setting is available for the routers supporting ISDN function only. Before utilizing the ISDN dial backup feature, you must create a dial backup profile first. Please click **ISDN > Dialing to a Single ISP** to create the backup profile.

Dial Backup Mode

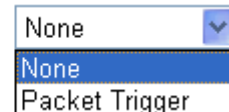

A dropdown menu with a blue arrow icon on the right. The menu is open, showing three options: 'None' (selected), 'None', and 'Packet Trigger'.

Note: This feature is available for ISDN 2 port only.

None - Disable the backup function.

Packet Trigger -The backup line is not on until a packet from a local host triggers the router to establish a connection.

PPP Setup

PPP Authentication - Select **PAP only** or **PAP or CHAP** for PPP.

Idle Timeout - Set the timeout for breaking down the Internet after passing through the time without any action. This setting is active only when the **Active on demand** option for Active Mode is selected in **WAN>> General Setup** page.

IP Address Assignment Method(IPCP)

Usually ISP dynamically assigns IP address to you each time you connect to it and request. In some case, your ISP provides service to always assign you the same IP address whenever you request. In this case, you can fill in this IP address in the Fixed IP field. Please contact your ISP before you want to use this function.

WAN IP Alias - If you have multiple public IP addresses and would like to utilize them on the WAN interface, please use WAN IP Alias. You can set up to 8 public IP addresses other than the current one you are using. Notice that this setting is available for WAN1 only. Type the additional WAN IP address and check the Enable box. Then click OK to exit the dialog.

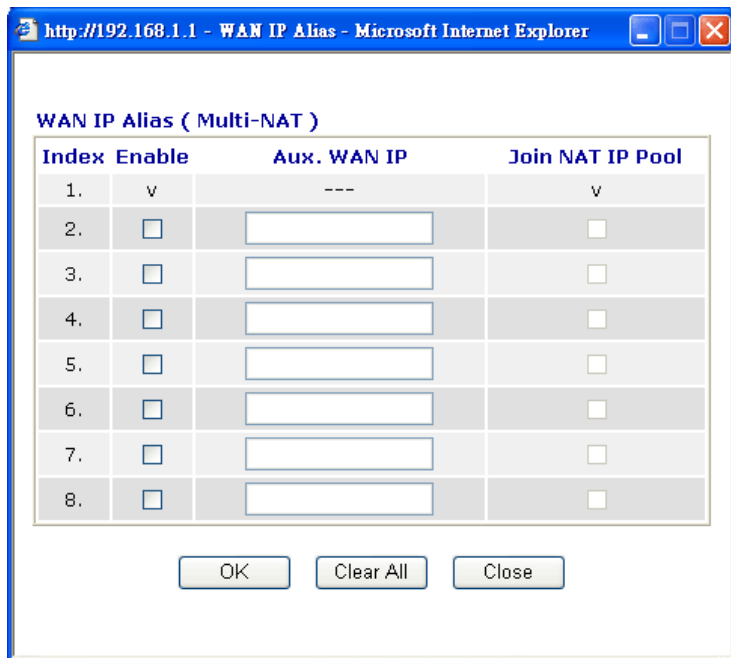

Click **Yes** to use this function and type in a fixed IP address in the box.

Fixed IP - Click **Yes** to use this function and type in a fixed IP address in the box of **Fixed IP Address**.

Fixed IP Address -Type a fixed IP address.

Obtain an IP address automatically – Click this button to obtain the IP address automatically.

Specify an IP address – Click this radio button to specify some data.

IP Address – Type the IP address.

Subnet Mask – Type the subnet mask.

WAN IP Network Settings

PPP for WAN2

Such mode is active only **3G USB Modem** was chosen as the physical mode in General Setup.

[WAN >> Internet Access](#)

WAN 2

PPP Client Mode	<input type="radio"/> Enable <input checked="" type="radio"/> Disable
SIM PIN code	<input type="text"/>
Modem Initial String	<input type="text" value="AT&FE0V1X1&D2&C1S0=0"/> (Default: AT&FE0V1X1&D2&C1S0=0)
APN Name	<input type="text"/> <input type="button" value="Apply"/>
Modem Dial String	<input type="text" value="ATDT*99#"/> (Default: ATDT*99#)
PPP Username	<input type="text"/> (Optional)
PPP Password	<input type="text"/> (Optional)
Index(1-15) in Schedule Setup:	
=>	<input type="text"/> , <input type="text"/> , <input type="text"/> , <input type="text"/>

- PPP Client Mode** Click Enable to activate this mode for WAN2.
- SIM PIN code** Type PIN code of the SIM card that will be used to access Internet.
- Modem Initial String** Such value is used to initialize USB modem. Please use the default value. If you have any question, please contact to your ISP.
- APN Name** APN(Access Point Name) is provided by your ISP for identifying different access points. Simply click **Apply** to apply such name. Finally, you have to click **OK** to save the setting.
- Apply** – Activate the function of identification.
- Modem Dial String** Such value is used to dial through USB mode. Please use the default value. If you have any question, please contact to your ISP.
- PPP Username** Type the PPP username (optional).
- PPP Password** Type the PPP password (optional).
- Index (1-15)** Set the PCs on LAN to work at certain time interval only. You may choose up to 4 schedules out of the 15 schedules pre-defined in **Applications >> Schedule** setup. The default setting of this filed is blank and the function will always work.

5.1.5 Multi-PVCs

This router allows you to create multi-PVCs for different data transferring for using. Simply go to **Internet Access** and select **Multi-PVC Setup** page.

General

The system allows you to set up to eight channels which are ready for choosing as the first PVC line that will be used as multi-PVCs.

[WAN >> Multi-PVCs](#)

Multi-PVCs

General		ATM QoS		Port-based Bridge		
Channel	Enable	VPI	VCI	QoS Type	Protocol	Encapsulation
1.	<input checked="" type="checkbox"/>	0	33	UBR	PPPoE	LLC/SNAP
2.	<input checked="" type="checkbox"/>	0	88	UBR	MPoA	1483 Bridged IP LLC
3.	WAN <input type="checkbox"/>	1	43	UBR	PPPoA	VC MUX
4.	WAN <input type="checkbox"/>	1	44	UBR	PPPoA	VC MUX
5.	WAN <input type="checkbox"/>	1	45	UBR	PPPoA	VC MUX
6.	<input type="checkbox"/>	1	46	UBR	PPPoA	VC MUX
7.	<input type="checkbox"/>	1	47	UBR	PPPoA	VC MUX
8.	<input type="checkbox"/>	1	48	UBR	PPPoA	VC MUX

Note: VPI/VCI must be unique for each channel!

OK Clear Cancel

Enable

Check this box to enable that channel. The channels that you enabled here will be shown in the **Multi-PVC channel** drop down list on the web page of **Internet Access**. Though you can enable eight channels in this page, yet only one channel can be chosen on the web page of **Internet Access**.

VPI

Type in the value provided by your ISP.

VCI

Type in the value provided by your ISP.

QoS Type

Select a proper QoS type for the channel.

QoS Type

UBR
 UBR
 CBR
 ABR
 nrtVBR
 rtVBR

Protocol

Select a proper protocol for this channel.

Protocol

PPPoE
 PPPoA
 PPPoE
 MPoA

Encapsulation

Choose a proper type for this channel. The types will be different according to the protocol setting that you choose.

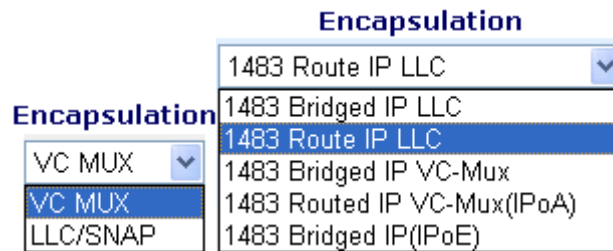

WAN link for Channel 3, 4, 5 are provided for router-borne application such as TR069 and VoIP. The settings must be applied and obtained from your ISP. For your special request, please contact with your ISP and then click WAN link of Channel 3, 4 or 5 to configure your router.

WAN >> Multi-PVCs >> PVC Channel 3

WAN for Router-borne Application: Management

Enable Disable

DSL Modem Settings

VPI: 1 QoS Type: UBR
VCI: 43 Protocol: PPPoA
Encapsulation: VC MUX

PPPoE/PPPoA Client

ISP Access Setup

ISP Name: _____
Username: _____
Password: _____
PPP Authentication: PAP or CHAP
 Always On
Idle Timeout: -1 second(s)

IP Address From ISP

Fixed IP: Yes No (Dynamic IP)
Fixed IP Address: _____

MPoA (RFC1483/2684)

Obtain an IP address automatically
Router Name: _____*
Domain Name: _____*
*: Required for some ISPs
 Specify an IP address
IP Address: _____
Subnet Mask: _____
Gateway IP Address: _____

DNS Server IP Address

Primary IP Address: _____
Secondary IP Address: _____

OK Cancel

WAN for Router-borne Application

Choose the router service for channel 3, 4 or 5.

Management - It can be specified for general management (Web configuration/telnet/TR069). If you choose Management, the configuration for this PVC will be effective for Web configuration/telnet/TR069.

VoIP - It can be specified for VoIP only. If you choose VoIP, the configuration for this PVC will be effective for VoIP data transmitting and receiving.

Enable/Disable

Click **Enable** for activating this function. If you click **Disable**,

this function will be closed and all the settings that you adjusted in this page will be invalid.

DSL Modem Settings

Set up the DSL parameters required by your ISP. These are vital for building DSL connection to your ISP.

VPI - Type in the value provided by ISP.

VCI - Type in the value provided by ISP.

QoS Type -Select a proper QoS type for the channel.

Protocol - Select a proper protocol for this channel. There are three options, PPPoE, PPPoA and MPoA for you to select. The following settings will be changed according to the protocol selected here.

Encapsulating Type - Drop down the list to choose the type provided by ISP.

ISP Access Setup

Enter your allocated username, password and authentication parameters according to the information provided by your ISP. If you want to connect to Internet all the time, you can check **Always On**.

Username – Type in the username provided by ISP in this field.

Password – Type in the password provided by ISP in this field.

PPP Authentication – Select **PAP only** or **PAP or CHAP** for PPP.

Idle Timeout – Set the timeout for breaking down the Internet after passing through the time without any action. This setting is active only when the **Always On** option is note selected.

IP Address from ISP

Fixed IP - Click **Yes** to use this function and type in a fixed IP address in the box of **Fixed IP Address**.

Fixed IP Address -Type a fixed IP address.

Obtain an IP address automatically

Click this button to obtain the IP address automatically.

Router Name – Type in the router name provided by ISP.

Domain Name – Type in the domain name that you have assigned.

Specify an IP address

Click this radio button to specify some data.

IP Address – Type in the private IP address.

Subnet Mask – Type in the subnet mask.

Gateway IP Address – Type in gateway IP address.

DNS Server IP Address

Type in the primary IP address for the router. If necessary, type in secondary IP address for necessity in the future.

ATM QoS

Such configuration is applied to upstream packets. Such information will be provided by ISP. Please contact with your ISP for detailed information.

[WAN >> Multi-PVCs](#)

Multi-PVCs

General		ATM QoS		Port-based Bridge		
Channel	QoS Type	PCR	SCR	MBS		
1.	UBR	0	0	0		
2.	UBR	0	0	0		
3.	UBR	0	0	0		
4.	UBR	0	0	0		
5.	UBR	0	0	0		
6.	UBR	0	0	0		
7.	UBR	0	0	0		
8.	UBR	0	0	0		

Note: 1.Set 0 means default value.

2.PCR(max) = ADSL Up Speed / 53 / 8.

OK Clear Cancel

QoS Type

Select a proper QoS type for the channel according to the information that your ISP provides.

QoS Type

UBR

- UBR
- CBR
- ABR
- rtVBR
- ntVBR

PCR

It represents Peak Cell Rate. The default setting is "0".

SCR

It represents Sustainable Cell Rate. The value of SCR must be smaller than PCR.

MBS

It represents Maximum Burst Size. The range of the value is 10 to 50.

Port-based Bridge

General page lets you set the first PVC. As to set the second PVC line, please click the **Port-based Bridge** tab to open Bridge configuration page.

[WAN >> Multi-PVCs](#)

Multi-PVCs

General		ATM QoS		Port-based Bridge					
Channel	Enable	P1	P2	P3	P4	Service Type	Add Tag		
1.	<input type="checkbox"/>	<input type="checkbox"/>	<input type="checkbox"/>	<input type="checkbox"/>	<input type="checkbox"/>	Normal	<input type="checkbox"/>	<input type="text"/>	
2.	<input type="checkbox"/>	<input type="checkbox"/>	<input type="checkbox"/>	<input type="checkbox"/>	<input type="checkbox"/>	Normal	<input type="checkbox"/>	<input type="text"/>	
3.	<input checked="" type="checkbox"/>	<input type="checkbox"/>	<input type="checkbox"/>	<input type="checkbox"/>	<input type="checkbox"/>	Normal	<input type="checkbox"/>	<input type="text"/>	
4.	<input checked="" type="checkbox"/>	<input type="checkbox"/>	<input type="checkbox"/>	<input type="checkbox"/>	<input type="checkbox"/>	Normal	<input type="checkbox"/>	<input type="text"/>	
5.	<input type="checkbox"/>	<input type="checkbox"/>	<input type="checkbox"/>	<input type="checkbox"/>	<input type="checkbox"/>	Normal IGMP	<input type="checkbox"/>	<input type="text"/>	
6.	<input type="checkbox"/>	<input type="checkbox"/>	<input type="checkbox"/>	<input type="checkbox"/>	<input type="checkbox"/>	Normal	<input type="checkbox"/>	<input type="text"/>	
7.	<input type="checkbox"/>	<input type="checkbox"/>	<input type="checkbox"/>	<input type="checkbox"/>	<input type="checkbox"/>	Normal	<input type="checkbox"/>	<input type="text"/>	
8.	<input type="checkbox"/>	<input type="checkbox"/>	<input type="checkbox"/>	<input type="checkbox"/>	<input type="checkbox"/>	Normal	<input type="checkbox"/>	<input type="text"/>	

Note: 1.Channel 1 to 2 are reserved for Nat/Route use.

2.P1 is reserved for Nat/Route use.

OK Clear Cancel

Enable

Check this box to enable that channel. Only channel 3 to 8 can be set in this page, for channel 1 to 4 are reserved for NAT using.

P1 to P4

It means the LAN port 1 to 4. Check the box to designate the LAN port for channel 3 to 8.

Service Type

Normally, service type is used for the service of video stream (e.g., IPTV). It can divide the packets from remote control and from video stream into different PVC. In general, the protocol used by remote control is IGMP.

Normal
Normal
IGMP

Normal – It means that the PVC can accept all packets except IGMP.

IGMP – It means that the PVC can accept packets of IGMP only.

Add Tag

To identify the usage of PVC, check this box to invoke this setting. And type the number for VLAN ID (number).

Click **Clear** to remove all the configurations in this page if you do not satisfy it. When you finish the configuration, please click **OK** to save and exit this page. Or click **Cancel** to abort the configuration and exit this page.

5.1.6 Load-Balance Policy

This router supports the function of load balancing. It can assign traffic with protocol type, IP address for specific host, a subnet of hosts, and port range to be allocated in WAN1 or WAN2 interface. The user can assign traffic category and force it to go to dedicate network interface based on the following web page setup. Twenty policies of load-balance are supported by this router.

Note: Load-Balance Policy is running only when both WAN1 and WAN2 are activated.

[WAN >> Load-Balance Policy](#)

Load-Balance Policy

Index	Enable	Protocol	WAN	Src IP Start	Src IP End	Dest IP Start	Dest IP End	Dest Port Start	Dest Port End	Move Up	Move Down
1	<input type="checkbox"/>	any	WAN1								Down
2	<input type="checkbox"/>	any	WAN1							UP	Down
3	<input type="checkbox"/>	any	WAN1							UP	Down
4	<input type="checkbox"/>	any	WAN1							UP	Down
5	<input type="checkbox"/>	any	WAN1							UP	Down
6	<input type="checkbox"/>	any	WAN1							UP	Down
7	<input type="checkbox"/>	any	WAN1							UP	Down
8	<input type="checkbox"/>	any	WAN1							UP	Down
9	<input type="checkbox"/>	any	WAN1							UP	Down
10	<input type="checkbox"/>	any	WAN1							UP	Down

<< [1-10](#) | [11-20](#) >>

[Next](#) >>

OK

Index Click the number of index to access into the load-balance policy configuration web page.

Enable Check this box to enable this policy.

Protocol Use the drop-down menu to change the protocol for the WAN interface.

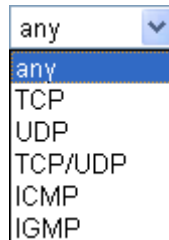

WAN Use the drop-down menu to change the WAN interface.

Src IP Start Displays the IP address for the start of the source IP.

- Src IP End** Displays the IP address for the end of the source IP.
- Dest IP Start** Displays the IP address for the start of the destination IP.
- Dest IP End** Displays the IP address for the end of the destination IP.
- Dest Port Start** Displays the IP address for the start of the destination port.
- Dest Port End** Displays the IP address for the end of the destination port.
- Move UP/Move Down** Use **Up** or **Down** link to move the order of the policy.

Click **Index 1** to access into the following page for configuring load-balance policy.

[WAN >> Load-Balance Policy](#)

Index: 1

<input checked="" type="checkbox"/> Enable	
Protocol	TCP
Binding WAN Interface	WAN1
Src IP Start	192.168.1.6
Src IP End	192.168.1.9
Dest IP Start	168.95.0.0
Dest IP End	168.95.1.100
Dest Port Start	80
Dest Port End	100

- Enable** Check this box to enable this policy.
- Protocol** Use the drop-down menu to choose a proper protocol for the WAN interface.

Protocol

any

any

TCP

UDP

TCP/UDP

ICMP

IGMP

- Binding WAN interface** Choose the WAN interface (WAN1 or WAN2) for binding.
- Src IP Start** Type the source IP start for the specified WAN interface.
- Src IP End** Type the source IP end for the specified WAN interface. If this field is blank, it means that all the source IPs inside the LAN will be passed through the WAN interface.
- Dest IP Start** Type the destination IP start for the specified WAN interface.

Dest IP End	Type the destination IP end for the specified WAN interface. If this field is blank, it means that all the destination IPs will be passed through the WAN interface.
Dest Port Start	Type the destination port start for the destination IP.
Dest Port End	Type the destination port end for the destination IP. If this field is blank, it means that all the destination ports will be passed through the WAN interface.

5.2 LAN

Local Area Network (LAN) is a group of subnets regulated and ruled by router. The design of network structure is related to what type of public IP addresses coming from your ISP.

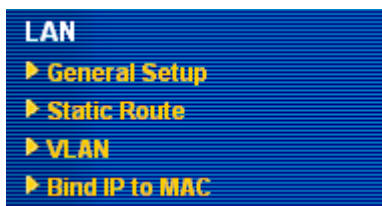

5.2.1 Basics of LAN

The most generic function of Vigor router is NAT. It creates a private subnet of your own. As mentioned previously, the router will talk to other public hosts on the Internet by using public IP address and talking to local hosts by using its private IP address. What NAT does is to translate the packets from public IP address to private IP address to forward the right packets to the right host and vice versa. Besides, Vigor router has a built-in DHCP server that assigns private IP address to each local host. See the following diagram for a briefly understanding.

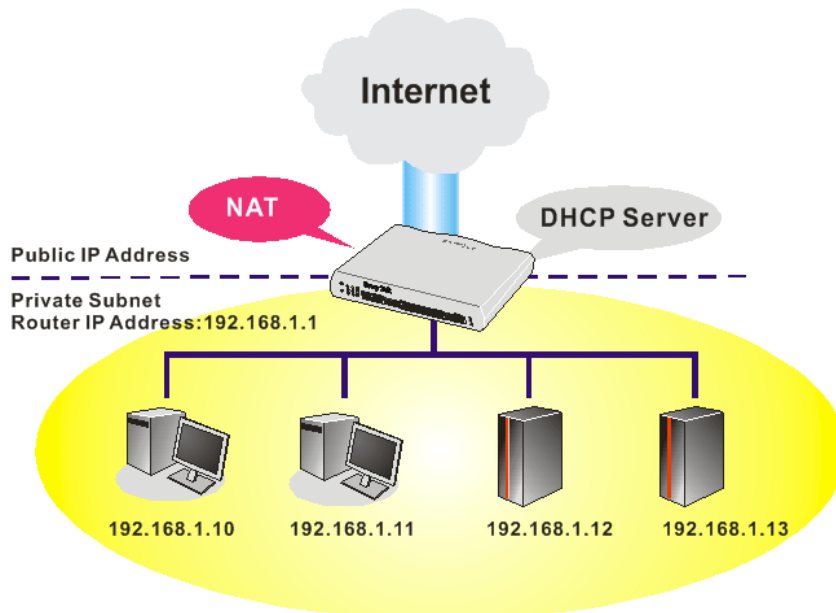

In some special case, you may have a public IP subnet from your ISP such as 220.135.240.0/24. This means that you can set up a public subnet or call second subnet that each host is equipped with a public IP address. As a part of the public subnet, the Vigor router will serve for IP routing to help hosts in the public subnet to communicate with other

public hosts or servers outside. Therefore, the router should be set as the gateway for public hosts.

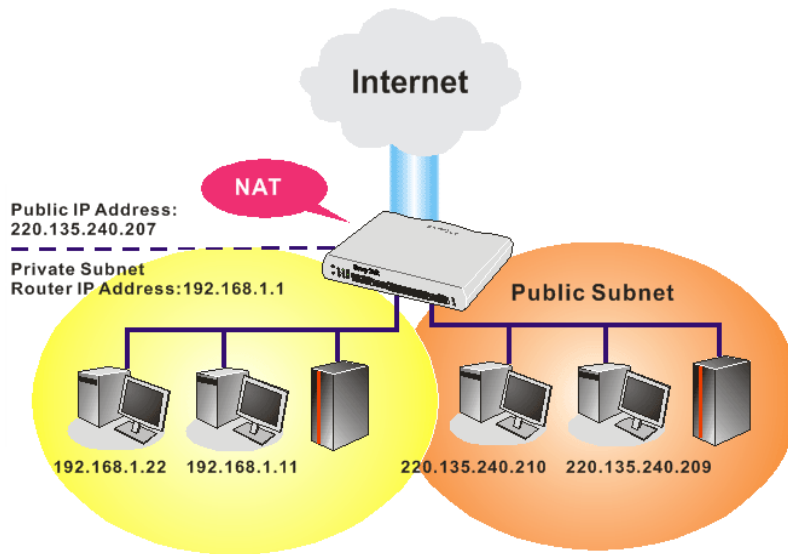

What is Routing Information Protocol (RIP)

Vigor router will exchange routing information with neighboring routers using the RIP to accomplish IP routing. This allows users to change the information of the router such as IP address and the routers will automatically inform for each other.

What is Static Route

When you have several subnets in your LAN, sometimes a more effective and quicker way for connection is the **Static routes** function rather than other method. You may simply set rules to forward data from one specified subnet to another specified subnet without the presence of RIP.

What are Virtual LANs

You can group local hosts by physical ports and create up to 4 virtual LANs. To manage the communication between different groups, please set up rules in Virtual LAN (VLAN) function and the rate of each.

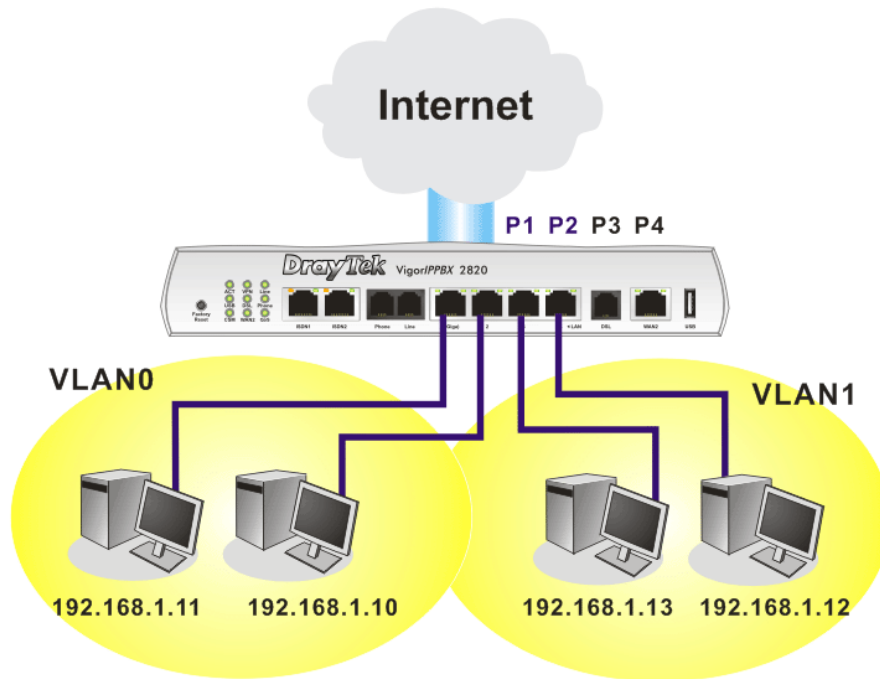

5.2.2 General Setup

This page provides you the general settings for LAN.

Click **LAN** to open the LAN settings page and choose **General Setup**.

[LAN >> General Setup](#)

Ethernet TCP / IP and DHCP Setup

LAN IP Network Configuration	DHCP Server Configuration
For NAT Usage	<input checked="" type="radio"/> Enable Server <input type="radio"/> Disable Server
1st IP Address: <input type="text" value="192.168.1.1"/>	Relay Agent: <input type="radio"/> 1st Subnet <input type="radio"/> 2nd Subnet
1st Subnet Mask: <input type="text" value="255.255.255.0"/>	Start IP Address: <input type="text" value="192.168.1.10"/>
For IP Routing Usage: <input type="radio"/> Enable <input checked="" type="radio"/> Disable	IP Pool Counts: <input type="text" value="50"/>
2nd IP Address: <input type="text" value="192.168.2.1"/>	Gateway IP Address: <input type="text" value="192.168.1.1"/>
2nd Subnet Mask: <input type="text" value="255.255.255.0"/>	DHCP Server IP Address for Relay Agent: <input type="text"/>
<input type="button" value="2nd Subnet DHCP Server"/>	
RIP Protocol Control: <input type="text" value="Disable"/>	DNS Server IP Address
	<input type="checkbox"/> Force DNS manual setting
	Primary IP Address: <input type="text"/>
	Secondary IP Address: <input type="text"/>

- 1st IP Address** Type in private IP address for connecting to a local private network (Default: 192.168.1.1).
- 1st Subnet Mask** Type in an address code that determines the size of the network. (Default: 255.255.255.0/ 24)
- For IP Routing Usage** Click **Enable** to invoke this function. The default setting is **Disable**.
- 2nd IP Address** Type in secondary IP address for connecting to a subnet. (Default: 192.168.2.1/ 24)
- 2nd Subnet Mask** An address code that determines the size of the network.

(Default: 255.255.255.0/ 24)

2nd DHCP Server

You can configure the router to serve as a DHCP server for the 2nd subnet.

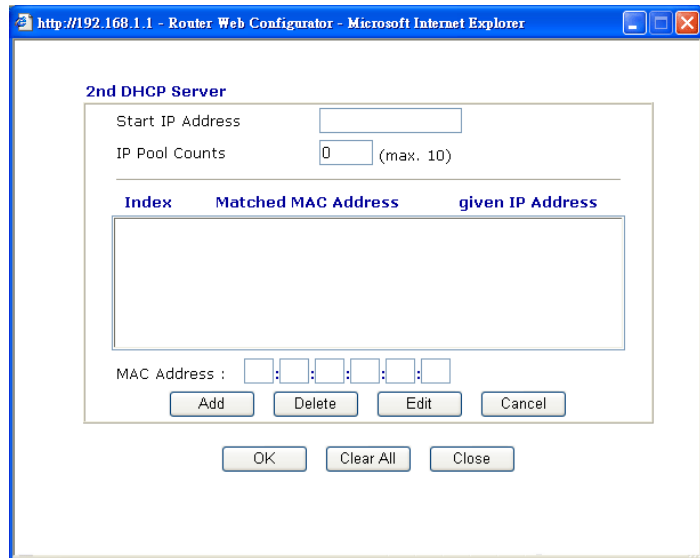

Start IP Address: Enter a value of the IP address pool for the DHCP server to start with when issuing IP addresses. If the 2nd IP address of your router is 220.135.240.1, the starting IP address must be 220.135.240.2 or greater, but smaller than 220.135.240.254.

IP Pool Counts: Enter the number of IP addresses in the pool. The maximum is 10. For example, if you type 3 and the 2nd IP address of your router is 220.135.240.1, the range of IP address by the DHCP server will be from 220.135.240.2 to 220.135.240.4.

MAC Address: Enter the MAC Address of the host one by one and click **Add** to create a list of hosts to be assigned, deleted or edited IP address from above pool. Set a list of MAC Address for 2nd DHCP server will help router to assign the correct IP address of the correct subnet to the correct host. So those hosts in 2nd subnet won't get an IP address belonging to 1st subnet.

RIP Protocol Control

Disable deactivates the RIP protocol. It will lead to a stoppage of the exchange of routing information between routers. (Default)

RIP Protocol Control

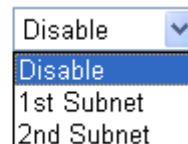

1st Subnet - Select the router to change the RIP information of the 1st subnet with neighboring routers.

2nd Subnet - Select the router to change the RIP information of the 2nd subnet with neighboring routers.

DHCP Server Configuration

DHCP stands for Dynamic Host Configuration Protocol. The router by factory default acts a DHCP server for your network so it automatically dispatch related IP settings to any local user

configured as a DHCP client. It is highly recommended that you leave the router enabled as a DHCP server if you do not have a DHCP server for your network.

If you want to use another DHCP server in the network other than the Vigor Router's, you can let Relay Agent help you to redirect the DHCP request to the specified location.

Enable Server - Let the router assign IP address to every host in the LAN.

Disable Server – Let you manually assign IP address to every host in the LAN.

Relay Agent – (1st subnet/2nd subnet) Specify which subnet that DHCP server is located the relay agent should redirect the DHCP request to.

Start IP Address - Enter a value of the IP address pool for the DHCP server to start with when issuing IP addresses. If the 1st IP address of your router is 192.168.1.1, the starting IP address must be 192.168.1.2 or greater, but smaller than 192.168.1.254.

IP Pool Counts - Enter the maximum number of PCs that you want the DHCP server to assign IP addresses to. The default is 50 and the maximum is 253.

Gateway IP Address - Enter a value of the gateway IP address for the DHCP server. The value is usually as same as the 1st IP address of the router, which means the router is the default gateway.

DHCP Server IP Address for Relay Agent - Set the IP address of the DHCP server you are going to use so the Relay Agent can help to forward the DHCP request to the DHCP server.

DNS Server Configuration

DNS stands for Domain Name System. Every Internet host must have a unique IP address, also they may have a human-friendly, easy to remember name such as www.yahoo.com. The DNS server converts the user-friendly name into its equivalent IP address.

Force DNS manual setting - Force Vigor router to use DNS servers in this page instead of DNS servers given by the Internet Access server (PPPoE, PPTP, L2TP or DHCP server).

Primary IP Address - You must specify a DNS server IP address here because your ISP should provide you with usually more than one DNS Server. If your ISP does not provide it, the router will automatically apply default DNS Server IP address: 194.109.6.66 to this field.

Secondary IP Address - You can specify secondary DNS server IP address here because your ISP often provides you more than one DNS Server. If your ISP does not provide it, the router will automatically apply default secondary DNS Server IP address: 194.98.0.1 to this field.

The default DNS Server IP address can be found via Online Status:

System Status		System Uptime: 2:10:17	
LAN Status	Primary DNS: 194.109.6.66	Secondary DNS: 168.95.1.1	
IP Address	TX Packets	RX Packets	
192.168.1.1	7508	175019	

If both the Primary IP and Secondary IP Address fields are left empty, the router will assign its own IP address to local users as a DNS proxy server and maintain a DNS cache.

If the IP address of a domain name is already in the DNS cache, the router will resolve the domain name immediately. Otherwise, the router forwards the DNS query packet to the external DNS server by establishing a WAN (e.g. DSL/Cable) connection.

There are two common scenarios of LAN settings that stated in Chapter 4. For the configuration examples, please refer to that chapter to get more information for your necessity.

5.2.3 Static Route

Go to **LAN** to open setting page and choose **Static Route**.

[LAN >> Static Route Setup](#)

Static Route Configuration			Set to Factory Default	View Routing Table	
Index	Destination Address	Status	Index	Destination Address	Status
1.	???	?	6.	???	?
2.	???	?	7.	???	?
3.	???	?	8.	???	?
4.	???	?	9.	???	?
5.	???	?	10.	???	?

Status: v --- Active, x --- Inactive, ? --- Empty

- Index** The number (1 to 10) under Index allows you to open next page to set up static route.
- Destination Address** Displays the destination address of the static route.
- Status** Displays the status of the static route.
- Viewing Routing Table** Displays the routing table for your reference.

[Diagnostics >> View Routing Table](#)

Current Running Routing Table			Refresh
Key: C - connected, S - static, R - RIP, * - default, ~ - private			
*	0.0.0.0/	0.0.0.0 via 172.16.3.4,	WAN2
C~	192.168.1.0/	255.255.255.0 is directly connected,	LAN
C	172.16.0.0/	255.255.0.0 is directly connected,	WAN2

Add Static Routes to Private and Public Networks

Here is an example of setting Static Route in Main Router so that user A and B locating in different subnet can talk to each other via the router. Assuming the Internet access has been configured and the router works properly:

- use the Main Router to surf the Internet.
- create a private subnet 192.168.10.0 using an internal Router A (192.168.1.2)
- create a public subnet 211.100.88.0 via an internal Router B (192.168.1.3).
- have set Main Router 192.168.1.1 as the default gateway for the Router A 192.168.1.2.

Before setting Static Route, user A cannot talk to user B for Router A can only forward recognized packets to its default gateway Main Router.

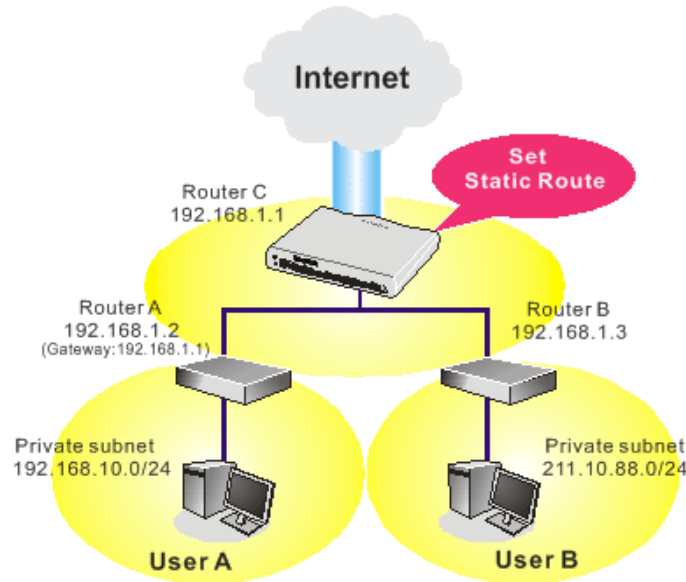

1. Go to **LAN** page and click **General Setup**, select 1st Subnet as the **RIP Protocol Control**. Then click the **OK** button.

Note: There are two reasons that we have to apply RIP Protocol Control on 1st Subnet. The first is that the LAN interface can exchange RIP packets with the neighboring routers via the 1st subnet (192.168.1.0/24). The second is that those hosts on the internal private subnets (ex. 192.168.10.0/24) can access the Internet via the router, and continuously exchange of IP routing information with different subnets.

2. Click the **LAN - Static Route** and click on the **Index Number 1**. Check the **Enable** box. Please add a static route as shown below, which regulates all packets destined to 192.168.10.0 will be forwarded to 192.168.1.2. Click **OK**.

[LAN >> Static Route Setup](#)

Index No. 1

<input checked="" type="checkbox"/> Enable	
Destination IP Address	<input type="text" value="192.168.10.0"/>
Subnet Mask	<input type="text" value="255.255.255.0"/>
Gateway IP Address	<input type="text" value="192.168.1.2"/>
Network Interface	<input type="text" value="LAN"/>

3. Return to **Static Route Setup** page. Click on another **Index Number** to add another static route as show below, which regulates all packets destined to 211.100.88.0 will be forwarded to 192.168.1.3.

LAN >> Static Route Setup

Index No. 2

<input checked="" type="checkbox"/> Enable	
Destination IP Address	<input type="text" value="211.100.88.0"/>
Subnet Mask	<input type="text" value="255.255.255.0"/>
Gateway IP Address	<input type="text" value="192.168.1.3"/>
Network Interface	<input type="text" value="LAN"/>

OK

Cancel

4. Go to **Diagnostics** and choose **Routing Table** to verify current routing table.

Diagnostics >> View Routing Table

Current Running Routing Table

| Refresh |

```
Key: C - connected, S - static, R - RIP, * - default, ~ - private
S~ 192.168.10.0/ 255.255.255.0 via 192.168.1.2, LAN
C~ 192.168.1.0/ 255.255.255.0 is directly connected, LAN
S~ 211.100.88.0/ 255.255.255.0 via 192.168.1.3, LAN
```

5.2.4 VLAN

Virtual LAN function provides you a very convenient way to manage hosts by grouping them based on the physical ports. You can also manage the in/out rate of each port. Go to **LAN** page and select **VLAN**. The following page will appear. Click **Enable** to invoke VLAN function.

[LAN >> VLAN Configuration](#)

VLAN Configuration

Enable

	P1	P2	P3	P4	SSID1	SSID2	SSID3	SSID4
VLAN0	<input type="checkbox"/>	<input type="checkbox"/>	<input type="checkbox"/>	<input type="checkbox"/>	<input type="checkbox"/>	<input type="checkbox"/>	<input type="checkbox"/>	<input type="checkbox"/>
VLAN1	<input type="checkbox"/>	<input type="checkbox"/>	<input type="checkbox"/>	<input type="checkbox"/>	<input type="checkbox"/>	<input type="checkbox"/>	<input type="checkbox"/>	<input type="checkbox"/>
VLAN2	<input type="checkbox"/>	<input type="checkbox"/>	<input type="checkbox"/>	<input type="checkbox"/>	<input type="checkbox"/>	<input type="checkbox"/>	<input type="checkbox"/>	<input type="checkbox"/>
VLAN3	<input type="checkbox"/>	<input type="checkbox"/>	<input type="checkbox"/>	<input type="checkbox"/>	<input type="checkbox"/>	<input type="checkbox"/>	<input type="checkbox"/>	<input type="checkbox"/>
VLAN4	<input type="checkbox"/>	<input type="checkbox"/>	<input type="checkbox"/>	<input type="checkbox"/>	<input type="checkbox"/>	<input type="checkbox"/>	<input type="checkbox"/>	<input type="checkbox"/>
VLAN5	<input type="checkbox"/>	<input type="checkbox"/>	<input type="checkbox"/>	<input type="checkbox"/>	<input type="checkbox"/>	<input type="checkbox"/>	<input type="checkbox"/>	<input type="checkbox"/>
VLAN6	<input type="checkbox"/>	<input type="checkbox"/>	<input type="checkbox"/>	<input type="checkbox"/>	<input type="checkbox"/>	<input type="checkbox"/>	<input type="checkbox"/>	<input type="checkbox"/>
VLAN7	<input type="checkbox"/>	<input type="checkbox"/>	<input type="checkbox"/>	<input type="checkbox"/>	<input type="checkbox"/>	<input type="checkbox"/>	<input type="checkbox"/>	<input type="checkbox"/>

OK Clear Cancel

To add or remove a VLAN, please refer to the following example.

1. If, VLAN 0 is consisted of hosts linked to P1 and P2 and VLAN 1 is consisted of hosts linked to P3 and P4.

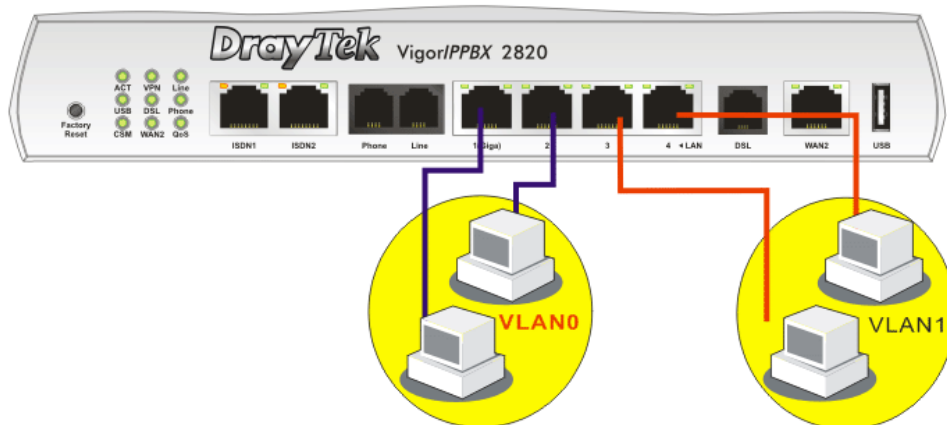

2. After checking the box to enable VLAN function, you will check the table according to the needs as shown below.

LAN >> VLAN Configuration

VLAN Configuration

<input checked="" type="checkbox"/> Enable								
	P1	P2	P3	P4	SSID1	SSID2	SSID3	SSID4
VLAN0	<input checked="" type="checkbox"/>	<input checked="" type="checkbox"/>	<input type="checkbox"/>	<input type="checkbox"/>	<input type="checkbox"/>	<input type="checkbox"/>	<input type="checkbox"/>	<input type="checkbox"/>
VLAN1	<input type="checkbox"/>	<input type="checkbox"/>	<input checked="" type="checkbox"/>	<input checked="" type="checkbox"/>	<input type="checkbox"/>	<input type="checkbox"/>	<input type="checkbox"/>	<input type="checkbox"/>
VLAN2	<input type="checkbox"/>	<input type="checkbox"/>	<input type="checkbox"/>	<input type="checkbox"/>	<input type="checkbox"/>	<input type="checkbox"/>	<input type="checkbox"/>	<input type="checkbox"/>
VLAN3	<input type="checkbox"/>	<input type="checkbox"/>	<input type="checkbox"/>	<input type="checkbox"/>	<input type="checkbox"/>	<input type="checkbox"/>	<input type="checkbox"/>	<input type="checkbox"/>
VLAN4	<input type="checkbox"/>	<input type="checkbox"/>	<input type="checkbox"/>	<input type="checkbox"/>	<input type="checkbox"/>	<input type="checkbox"/>	<input type="checkbox"/>	<input type="checkbox"/>
VLAN5	<input type="checkbox"/>	<input type="checkbox"/>	<input type="checkbox"/>	<input type="checkbox"/>	<input type="checkbox"/>	<input type="checkbox"/>	<input type="checkbox"/>	<input type="checkbox"/>
VLAN6	<input type="checkbox"/>	<input type="checkbox"/>	<input type="checkbox"/>	<input type="checkbox"/>	<input type="checkbox"/>	<input type="checkbox"/>	<input type="checkbox"/>	<input type="checkbox"/>
VLAN7	<input type="checkbox"/>	<input type="checkbox"/>	<input type="checkbox"/>	<input type="checkbox"/>	<input type="checkbox"/>	<input type="checkbox"/>	<input type="checkbox"/>	<input type="checkbox"/>

To remove VLAN, uncheck the needed box and click **OK** to save the results.

5.2.5 Bind IP to MAC

This function is used to bind the IP and MAC address in LAN to have a strengthening control in network. When this function is enabled, all the assigned IP and MAC address binding together cannot be changed. If you modified the binding IP or MAC address, it might cause you not access into the Internet.

Click **LAN** and click **Bind IP to MAC** to open the setup page.

[LAN >> Bind IP to MAC](#)

Bind IP to MAC

Note: IP-MAC binding presets DHCP Allocations.
If you select Strict Bind, unspecified LAN clients cannot access the Internet.

Enable
 Disable
 Strict Bind

ARP Table | [Select All](#) | [Sort](#) | [Refresh](#)

IP Address	Mac Address
192.168.1.10	00-0E-A6-2A-D5-A1

IP Bind List | [Select All](#) | [Sort](#)

Index	IP Address	Mac Address
-------	------------	-------------

Add and Edit

IP Address

Mac Address

Enable

Click this radio button to invoke this function. However, IP/MAC which is not listed in IP Bind List also can connect to Internet.

Disable

Click this radio button to disable this function. All the settings on this page will be invalid.

Strict Bind

Click this radio button to block the connection of the IP/MAC which is not listed in IP Bind List.

ARP Table

This table is the LAN ARP table of this router. The information for IP and MAC will be displayed in this field. Each pair of IP and MAC address listed in ARP table can be selected and added to IP Bind List by clicking **Add** below.

Add and Edit

IP Address – Type the IP address that will be used for the specified MAC address.

Mac Address – Type the MAC address that is used to bind with the assigned IP address.

Refresh

It is used to refresh the ARP table. When there is one new PC added to the LAN, you can click this link to obtain the newly ARP table information.

IP Bind List

It displays a list for the IP bind to MAC information.

Add	It allows you to add the one you choose from the ARP table or the IP/MAC address typed in Add and Edit to the table of IP Bind List .
Edit	It allows you to edit and modify the selected IP address and MAC address that you create before.
Remove	You can remove any item listed in IP Bind List . Simply click and select the one, and click Remove . The selected item will be removed from the IP Bind List .

Note: Before you select **Strict Bind**, you have to bind one set of IP/MAC address for one PC. If not, no one of the PCs can access into Internet. And the web configurator of the router might not be accessed.

5.3 NAT

Usually, the router serves as a NAT (Network Address Translation) router. NAT is a mechanism that one or more private IP addresses can be mapped into a single public one. Public IP address is usually assigned by your ISP, for which you may get charged. Private IP addresses are recognized only among internal hosts.

When the outgoing packets destined to some public server on the Internet reach the NAT router, the router will change its source address into the public IP address of the router, select the available public port, and then forward it. At the same time, the router shall list an entry in a table to memorize this address/port-mapping relationship. When the public server response, the incoming traffic, of course, is destined to the router's public IP address and the router will do the inversion based on its table. Therefore, the internal host can communicate with external host smoothly.

The benefit of the NAT includes:

- **Save cost on applying public IP address and apply efficient usage of IP address.** NAT allows the internal IP addresses of local hosts to be translated into one public IP address, thus you can have only one IP address on behalf of the entire internal hosts.
- **Enhance security of the internal network by obscuring the IP address.** There are many attacks aiming victims based on the IP address. Since the attacker cannot be aware of any private IP addresses, the NAT function can protect the internal network.

On NAT page, you will see the private IP address defined in RFC-1918. Usually we use the 192.168.1.0/24 subnet for the router. As stated before, the NAT facility can map one or more IP addresses and/or service ports into different specified services. In other words, the NAT function can be achieved by using port mapping methods.

Below shows the menu items for NAT.

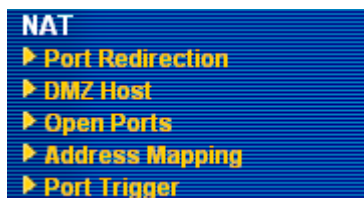

5.3.1 Port Redirection

Port Redirection is usually set up for server related service inside the local network (LAN), such as web servers, FTP servers, E-mail servers etc. Most of the case, you need a public IP address for each server and this public IP address/domain name are recognized by all users. Since the server is actually located inside the LAN, the network well protected by NAT of the router, and identified by its private IP address/port, the goal of Port Redirection function is to forward all access request with public IP address from external users to the mapping private IP address/port of the server.

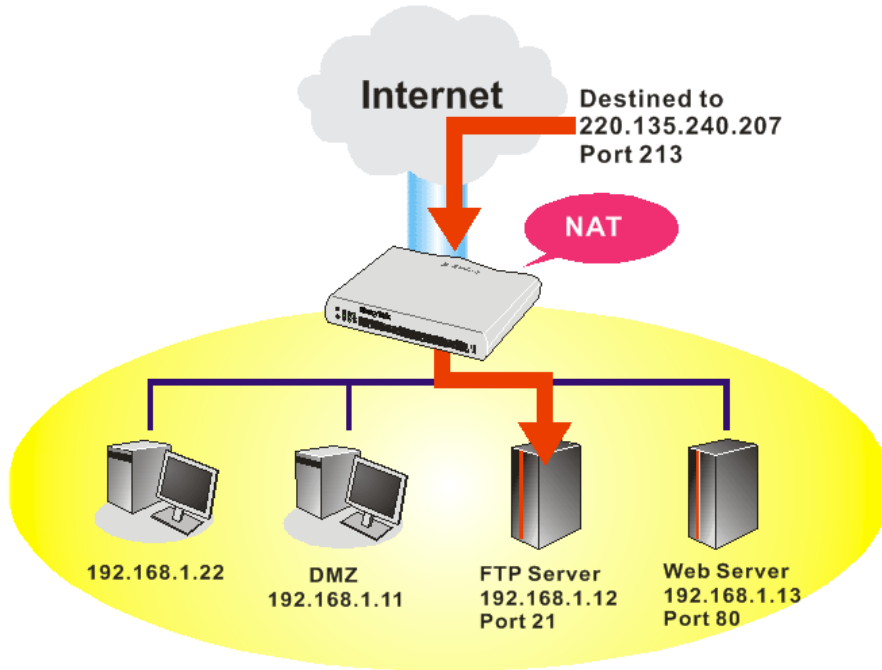

The port redirection can only apply to incoming traffic.

To use this function, please go to **NAT** page and choose **Port Redirection** web page. The **Port Redirection Table** provides 20 port-mapping entries for the internal hosts.

[NAT >> Port Redirection](#)

Port Redirection | [Set to Factory Default](#)

Index	Service Name	Public Port	Private IP	Status
1.				x
2.				x
3.				x
4.				x
5.				x
6.				x
7.				x
8.				x
9.				x
10.				x

<< [1-10](#) | [11-20](#) >> [Next](#) >>

Press any number under Index to access into next page for configuring port redirection.

NAT >> Port Redirection

Index No. 1

<input checked="" type="checkbox"/> Enable	
Mode	Range
Service Name	Single
Protocol	---
WAN IP	1.All
Public Port	0 -
Private IP	-
Private Port	0

Note: In "Range" Mode the End IP will be calculated automatically once the Public Port and Start IP have been entered.

OK Clear Cancel

- Enable** Check this box to enable such port redirection setting.
- Mode** Two options (Single and Range) are provided here for you to choose. To set a range for the specific service, select **Range**. In Range mode, if the public port (start port and end port) and the starting IP of private IP had been entered, the system will calculate and display the ending IP of private IP automatically.
- Service Name** Enter the description of the specific network service.
- Protocol** Select the transport layer protocol (TCP or UDP).
- WAN IP** Select the WAN IP used for port redirection. There are eight WAN IP alias that can be selected and used for port redirection. The default setting is **All** which means all the incoming data from any port will be redirected to specified range of IP address and port.
- Public Port** Specify which port can be redirected to the specified **Private IP and Port** of the internal host. If you choose **Range** as the port redirection mode, you will see two boxes on this field. Simply type the required number on the first box. The second one will be assigned automatically later.
- Private IP** Specify the private IP address of the internal host providing the service. If you choose **Range** as the port redirection mode, you will see two boxes on this field. Type a complete IP address in the first box (as the starting point) and the fourth digits in the second box (as the end point).
- Private Port** Specify the private port number of the service offered by the internal host.
- Active** Check this box to activate the port-mapping entry you have defined.

Note that the router has its own built-in services (servers) such as Telnet, HTTP and FTP etc. Since the common port numbers of these services (servers) are all the same, you may need to reset the router in order to avoid confliction.

For example, the built-in web configurator in the router is with default port 80, which may conflict with the web server in the local network, http://192.168.1.13:80. Therefore, you need

to **change the router's http port to any one other than the default port 80** to avoid conflict, such as 8080. This can be set in the **System Maintenance >>Management Setup**. You then will access the admin screen of by suffixing the IP address with 8080, e.g., http://192.168.1.1:8080 instead of port 80.

[System Maintenance >> Management](#)

Management Setup

<p>Management Access Control</p> <p><input type="checkbox"/> Allow management from the Internet</p> <p><input type="checkbox"/> FTP Server</p> <p><input checked="" type="checkbox"/> HTTP Server</p> <p><input checked="" type="checkbox"/> HTTPS Server</p> <p><input checked="" type="checkbox"/> Telnet Server</p> <p><input type="checkbox"/> SSH Server</p> <p><input checked="" type="checkbox"/> Disable PING from the Internet</p>	<p>Management Port Setup</p> <p><input checked="" type="radio"/> User Define Ports <input type="radio"/> Default Ports</p> <p>Telnet Port <input type="text" value="23"/> (Default: 23)</p> <p>HTTP Port <input type="text" value="80"/> (Default: 80)</p> <p>HTTPS Port <input type="text" value="443"/> (Default: 443)</p> <p>FTP Port <input type="text" value="21"/> (Default: 21)</p> <p>SSH Port <input type="text" value="22"/> (Default: 22)</p>												
<p>Access List</p> <table border="1"> <thead> <tr> <th>List</th> <th>IP</th> <th>Subnet Mask</th> </tr> </thead> <tbody> <tr> <td>1</td> <td><input type="text"/></td> <td><input type="text"/></td> </tr> <tr> <td>2</td> <td><input type="text"/></td> <td><input type="text"/></td> </tr> <tr> <td>3</td> <td><input type="text"/></td> <td><input type="text"/></td> </tr> </tbody> </table>	List	IP	Subnet Mask	1	<input type="text"/>	<input type="text"/>	2	<input type="text"/>	<input type="text"/>	3	<input type="text"/>	<input type="text"/>	<p>SNMP Setup</p> <p><input type="checkbox"/> Enable SNMP Agent</p> <p>Get Community <input type="text" value="public"/></p> <p>Set Community <input type="text" value="private"/></p> <p>Manager Host IP <input type="text"/></p> <p>Trap Community <input type="text" value="public"/></p> <p>Notification Host IP <input type="text"/></p> <p>Trap Timeout <input type="text" value="10"/> seconds</p>
List	IP	Subnet Mask											
1	<input type="text"/>	<input type="text"/>											
2	<input type="text"/>	<input type="text"/>											
3	<input type="text"/>	<input type="text"/>											

5.3.2 DMZ Host

As mentioned above, **Port Redirection** can redirect incoming TCP/UDP or other traffic on particular ports to the specific private IP address/port of host in the LAN. However, other IP protocols, for example Protocols 50 (ESP) and 51 (AH), do not travel on a fixed port. Vigor router provides a facility **DMZ Host** that maps ALL unsolicited data on any protocol to a single host in the LAN. Regular web surfing and other such Internet activities from other clients will continue to work without inappropriate interruption. **DMZ Host** allows a defined internal user to be totally exposed to the Internet, which usually helps some special applications such as Netmeeting or Internet Games etc.

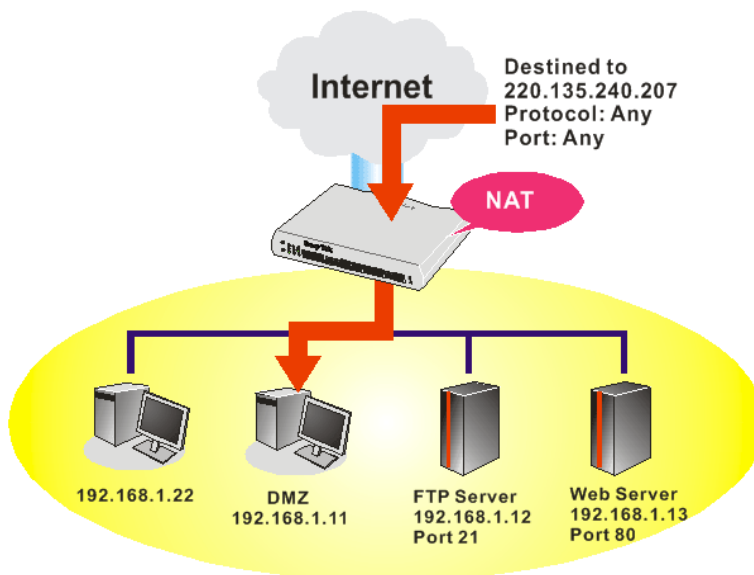

The inherent security properties of NAT are somewhat bypassed if you set up DMZ host. We suggest you to add additional filter rules or a secondary firewall.

Click **DMZ Host** to open the following page:

NAT >> DMZ Host Setup

DMZ Host Setup

WAN 1
 None
Private IP
MAC Address of the True IP DMZ Host
 Note: When a True-IP DMZ host is turned on, it will force the router's WAN connection to be always on.

WAN 2
 Enable **Private IP**

If you previously have set up **WAN Alias** for **PPPoE/PPPoA** or **MPoA** mode, you will find them in **Aux. WAN IP** for your selection.

NAT >> DMZ Host Setup

DMZ Host Setup

WAN 1			
Index	Enable	Aux. WAN IP	Private IP
1.	<input type="checkbox"/>	192.168.1.88	<input type="text"/> <input type="button" value="Choose PC"/>

WAN 2
 Enable **Private IP**

- Enable** Check to enable the DMZ Host function.
- Private IP** Enter the private IP address of the DMZ host, or click Choose PC to select one.
- Choose PC** Click this button and then a window will automatically pop up, as depicted below. The window consists of a list of private IP addresses of all hosts in your LAN network. Select one private IP address in the list to be the DMZ host.

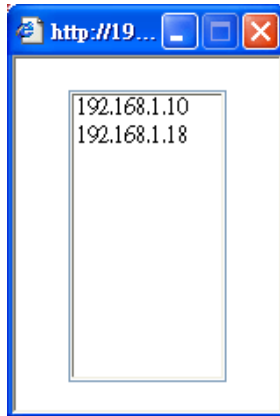

When you have selected one private IP from the above dialog, the IP address will be shown on the following screen. Click **OK** to save the setting.

[NAT >> DMZ Host Setup](#)

DMZ Host Setup

WAN 1				
Index	Enable	Aux. WAN IP	Private IP	
1.	<input checked="" type="checkbox"/>	192.168.1.88	192.168.1.10	<input type="button" value="Choose PC"/>

WAN 2				
Index	Enable	Aux. WAN IP	Private IP	
	<input type="checkbox"/>			<input type="button" value="Choose PC"/>

5.3.3 Open Ports

Open Ports allows you to open a range of ports for the traffic of special applications. Common application of Open Ports includes P2P application (e.g., BT, KaZaA, Gnutella, WinMX, eMule and others), Internet Camera etc. Ensure that you keep the application involved up-to-date to avoid falling victim to any security exploits.

Click **Open Ports** to open the following page:

[NAT >> Open Ports](#)

Open Ports Setup | [Set to Factory Default](#)

Index	Comment	WAN Interface	Local IP Address	Status
1.				x
2.				x
3.				x
4.				x
5.				x
6.				x
7.				x
8.				x
9.				x
10.				x

<< [1-10](#) | [11-20](#) >> [Next](#) >>

Index

Indicate the relative number for the particular entry that you want to offer service in a local host. You should click the appropriate index number to edit or clear the corresponding

entry.

- Comment** Specify the name for the defined network service.
- WAN Interface** Display the WAN interface for the entry.
- Local IP Address** Display the private IP address of the local host offering the service.
- Status** Display the state for the corresponding entry. X or V is to represent the **Inactive** or **Active** state.

To add or edit port settings, click one index number on the page. The index entry setup page will pop up. In each index entry, you can specify **10** port ranges for diverse services.

[NAT >> Open Ports >> Edit Open Ports](#)

Index No. 1

Enable Open Ports

Comment

WAN Interface

Local Computer

	Protocol	Start Port	End Port		Protocol	Start Port	End Port
1.	TCP	4500	4700	6.	----	0	0
2.	TCP	4500	4700	7.	----	0	0
3.	----	0	0	8.	----	0	0
4.	----	0	0	9.	----	0	0
5.	----	0	0	10.	----	0	0

- Enable Open Ports** Check to enable this entry.
- Comment** Make a name for the defined network application/service.
- WAN Interface** Specify the WAN interface that will be used for this entry.
- Local Computer** Enter the private IP address of the local host or click **Choose PC** to select one.
- Choose PC** Click this button and, subsequently, a window having a list of private IP addresses of local hosts will automatically pop up. Select the appropriate IP address of the local host in the list.
- Protocol** Specify the transport layer protocol. It could be **TCP**, **UDP**, or **----** (none) for selection.
- Start Port** Specify the starting port number of the service offered by the local host.
- End Port** Specify the ending port number of the service offered by the local host.

5.3.4 Address Mapping

This page is used to map specific private IP to specific WAN IP address.

If you have "a group of IP Addresses" and want to apply to the router, please use WAN IP alias function to record these IPs first. Then, use address mapping function to map specific private IP to specific WAN IP alias.

For example, you have IP addresses ranging from 86.123.123.1 ~ 86.123.123.8. However, your router uses 86.123.123.1, and the rest of the IPs are recorded in WAN IP alias. You want that private IP 192.168.1.10 can use 86.123.123.2 as source IP when it sends packet out to Internet. You can use address mapping function to achieve this demand. Simply type 192.168.1.10 as the Private IP; and type 86.123.123.2 as the WAN IP.

NAT >> Address Mapping

Address Mapping Setup					Set to Factory Default
Index	Protocol	Public IP	Private IP	Mask	Status
1.	ALL	---		/32	x
2.	ALL	---		/32	x
3.	ALL	---		/32	x
4.	ALL	---		/32	x
5.	ALL	---		/32	x
6.	ALL	---		/32	x
7.	ALL	---		/32	x
8.	ALL	---		/32	x
9.	ALL	---		/32	x
10.	ALL	---		/32	x

- Protocol** Display the protocol used for this address mapping.
- Public IP** Display the public IP address selected for this entry, e.g., 86.123.123.2.
- Private IP** Display the private IP set for this address mapping, e.g., 192.168.1.10
- Mask** Display the subnet mask selected for this address mapping.
- Status** Display the status for the entry, enable or disable.

Click the index number link to open the configuration page.

NAT >> Address Mapping

Index No. 1

Enable

Protocol: ALL ▾

WAN Interface: WAN1 ▾

WAN IP: ▾

Private IP:

Subnet Mask: /32 ▾

- Enable** Check to enable this entry.

Protocol Specify the transport layer protocol. It could be **TCP**, **UDP**, or **ALL** for selection.

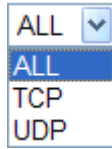

WAN Interface Specify the WAN interface that will be used for this entry.

WAN IP Select an IP address (the selections provided here are set in **IP Alias List** of **WAN>>Internet Access**). Local host can use this IP to connect to Internet.

If you want to choose any on of the Public IP settings, you must specify some IP addresses in the IP Alias List of the Static/DHCP Configuration page first. If you did not type in any IP address in the IP Alias List, the Public IP setting will be empty in this field. When you click **Apply**, a message will appear to inform you.

Private IP Assign an IP address (e.g., 192.168.1.10) or a subnet to be compared with the Public IP address for incoming packets.

Subnet Mask Select a value of subnet mask for private IP address.

5.3.5 Port Trigger

Port Trigger is a variation of open ports function; the difference is that the port trigger has the dynamic characteristics. It is more secure comparing to open ports.

In Open Ports setting, once we setup the ports be opened, all traffic can go through these open ports into LAN device; with Port Trigger function, the ports will be opened only when specific application triggers the specific ports, and then the needed ports will be opened automatically.

NAT >> Port Trigger

Port Trigger						Set to Factory Default
Index	Comment	Trigger Protocol	Trigger Port	Incoming Protocol	Incoming Port	Status
1.						x
2.						x
3.						x
4.						x
5.						x
6.						x
7.						x
8.						x
9.						x
10.						x

<< [1-10](#) | [11-20](#) >>

[Next](#) >>

Comment Display the text which memorizes the application of this rule.

Trigger Protocol Display the protocol of the trigger packets.

Trigger Port Display the port of the trigger packets.

Incoming Protocol Display the protocol for the incoming data of such trigger profile.

Incoming Port Display the port for the incoming data of such trigger profile.

Status Display if the rule is active or inactive.

Click the index number link to open the configuration page.

[NAT >> Port Trigger](#)

No. 1

<input checked="" type="checkbox"/> Enable	
Service	User Defined ▾
Comment	<input type="text"/>
Trigger Protocol	--- ▾
Trigger Port	<input type="text"/>
Incoming Protocol	--- ▾
Incoming Port	<input type="text"/>

Note: The Trigger Port and Incoming Port should be input like this :
123-456,777-789 (legal), 123-456,789 (legal), but 123-456-789 (illegal).

OK Clear Cancel

Enable

Check to enable this entry.

Service

Choose the **predefined** service to apply for such trigger profile.

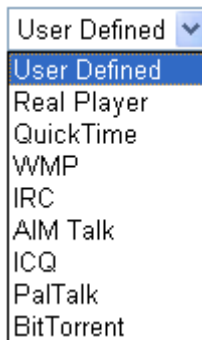

A dropdown menu showing the 'Service' selection. The current selection is 'User Defined'. Other options listed include Real Player, QuickTime, WMP, IRC, AIM Talk, ICQ, PalTalk, and BitTorrent.

Comment

Type the text to memorize the application of this rule.

Trigger Protocol

Select the protocol (TCP, UDP or TCP/UDP) for such trigger profile.

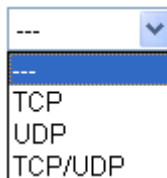

A dropdown menu showing the 'Trigger Protocol' selection. The current selection is '---'. Other options listed include TCP, UDP, and TCP/UDP.

Trigger Port

Type the port or port range for such trigger profile.

Incoming Protocol

When the trigger packets received, it is expected the incoming packets will use the selected protocol. Select the protocol (TCP, UDP or TCP/UDP) for the incoming data of such trigger profile.

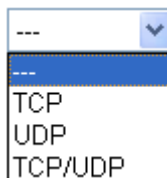

A dropdown menu showing the 'Incoming Protocol' selection. The current selection is '---'. Other options listed include TCP, UDP, and TCP/UDP.

Incoming Port

Type the port or port range for the incoming packets.

5.4 Firewall

5.4.1 Basics for Firewall

While the broadband users demand more bandwidth for multimedia, interactive applications, or distance learning, security has been always the most concerned. The firewall of the Vigor router helps to protect your local network against attack from unauthorized outsiders. It also restricts users in the local network from accessing the Internet. Furthermore, it can filter out specific packets that trigger the router to build an unwanted outgoing connection.

Firewall Facilities

The users on the LAN are provided with secured protection by the following firewall facilities:

- User-configurable IP filter (Call Filter/ Data Filter).
- Stateful Packet Inspection (SPI): tracks packets and denies unsolicited incoming data
- Selectable Denial of Service (DoS) /Distributed DoS (DDoS) attacks protection

IP Filters

Depending on whether there is an existing Internet connection, or in other words “the WAN link status is up or down”, the IP filter architecture categorizes traffic into two: **Call Filter** and **Data Filter**.

- **Call Filter** - When there is no existing Internet connection, **Call Filter** is applied to all traffic, all of which should be outgoing. It will check packets according to the filter rules. If legal, the packet will pass. Then the router shall “**initiate a call**” to build the Internet connection and send the packet to Internet.
- **Data Filter** - When there is an existing Internet connection, **Data Filter** is applied to incoming and outgoing traffic. It will check packets according to the filter rules. If legal, the packet will pass the router.

The following illustrations are flow charts explaining how router will treat incoming traffic and outgoing traffic respectively.

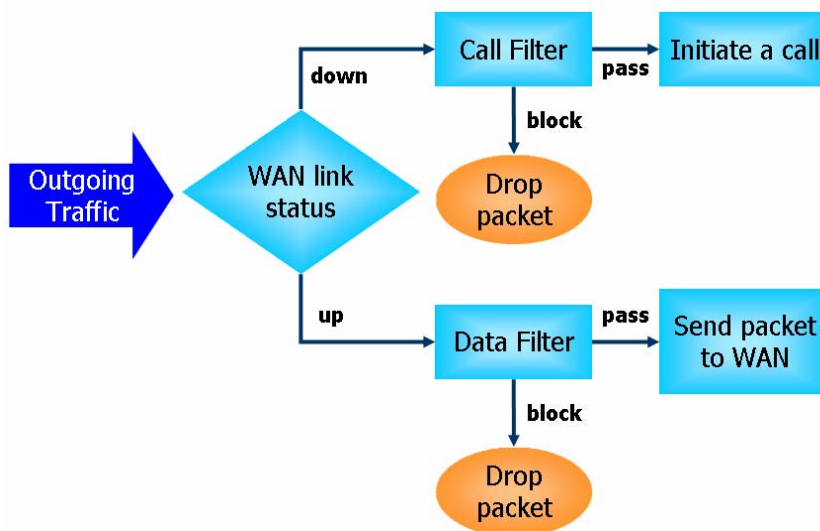

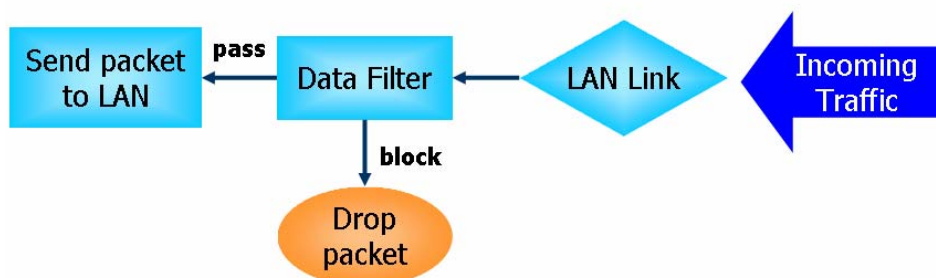

Stateful Packet Inspection (SPI)

Stateful inspection is a firewall architecture that works at the network layer. Unlike legacy static packet filtering, which examines a packet based on the information in its header, stateful inspection builds up a state machine to track each connection traversing all interfaces of the firewall and makes sure they are valid. The stateful firewall of Vigor router not just examine the header information also monitor the state of the connection.

Denial of Service (DoS) Defense

The **DoS Defense** functionality helps you to detect and mitigate the DoS attack. The attacks are usually categorized into two types, the flooding-type attacks and the vulnerability attacks. The flooding-type attacks will attempt to exhaust all your system's resource while the vulnerability attacks will try to paralyze the system by offending the vulnerabilities of the protocol or operation system.

The **DoS Defense** function enables the Vigor router to inspect every incoming packet based on the attack signature database. Any malicious packet that might duplicate itself to paralyze the host in the secure LAN will be strictly blocked and a Syslog message will be sent as warning, if you set up Syslog server.

Also the Vigor router monitors the traffic. Any abnormal traffic flow violating the pre-defined parameter, such as the number of thresholds, is identified as an attack and the Vigor router will activate its defense mechanism to mitigate in a real-time manner.

The below shows the attack types that DoS/DDoS defense function can detect:

- | | |
|----------------------|--------------------------|
| 1. SYN flood attack | 8. Trace route |
| 2. UDP flood attack | 9. SYN fragment |
| 3. ICMP flood attack | 10. Fraggle attack |
| 4. Port Scan attack | 11. TCP flag scan |
| 5. IP options | 12. Tear drop attack |
| 6. Land attack | 13. Ping of Death attack |
| 7. Smurf attack | 14. ICMP fragment |
| | 15. Unknown protocol |

Below shows the menu items for Firewall.

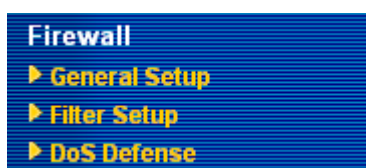

5.4.2 General Setup

General Setup allows you to adjust settings of IP Filter and common options. Here you can enable or disable the **Call Filter** or **Data Filter**. Under some circumstance, your filter set can be linked to work in a serial manner. So here you assign the **Start Filter Set** only. Also you can configure the **Log Flag** settings, and **Accept large incoming fragmented UDP or ICMP packets**.

Click **Firewall** and click **General Setup** to open the general setup page.

Firewall >> General Setup

General Setup

Call Filter	<input checked="" type="radio"/> Enable	Start Filter Set	Set#1
	<input type="radio"/> Disable		
Data Filter	<input checked="" type="radio"/> Enable	Start Filter Set	Set#2
	<input type="radio"/> Disable		

Actions for default rule:

Application	Action/Profile	Syslog
Filter	Pass	<input type="checkbox"/>
APP Enforcement	None	<input type="checkbox"/>
URL Content Filter	None	<input type="checkbox"/>
Web Content Filter	None	<input type="checkbox"/>

Advance Setting

Accept large incoming fragmented UDP or ICMP packets (for some games, ex. CS)

Enable Strict Security Firewall

Call Filter

Check **Enable** to activate the Call Filter function. Assign a start filter set for the Call Filter.

Data Filter

Check **Enable** to activate the Data Filter function. Assign a start filter set for the Data Filter.

Action/Profile

Select **Pass** or **Block** for the packets that do not match with the filter rules.

APP Enforcement

Select one of the **APP Enforcement Profile** settings (created in **CSM>> APP Enforcement Profile**) for applying with this router. Please set at least one profile for choosing in **CSM>> APP Enforcement Profile** web page first. For troubleshooting needs, you can specify to record information for **APP Enforcement Profile** by checking the Log box. It will be sent to Syslog server. Please refer to section **System Maintenance>> Syslog/Mail Alert** for more detailed information.

URL Content Filter

Select one of the **URL Content Filter Profile** settings (created in **CSM>> URL Content Filter Profile**) for applying with this router. Please set at least one profile for choosing in **CSM>> URL Content Filter Profile** web page first. For troubleshooting needs, you can specify to record information for **URL Content Filter** by checking the Log box. It will be

sent to Syslog server. Please refer to section **System Maintenance>>Syslog/Mail Alert** for more detailed information.

Web Content Filter

Select one of the **Web Content Filter Profile** settings (created in **CSM>> Web Content Filter Profile**) for applying with this router. Please set at least one profile for anti-virus in **CSM>> Web Content Filter Profile** web page first. For troubleshooting needs, you can specify to record information for **Web Content Filter Profile** by checking the Log box. It will be sent to Syslog server. Please refer to section **System Maintenance>> Syslog/Mail Alert** for more detailed information.

Syslog

For troubleshooting needs you can specify the filter log and/or CSM log here by checking the box. The log will be displayed on Draytek Syslog window.

Advance Setting

Click **Edit** to open the following window. However, it is **strongly recommended** to use the default settings here.

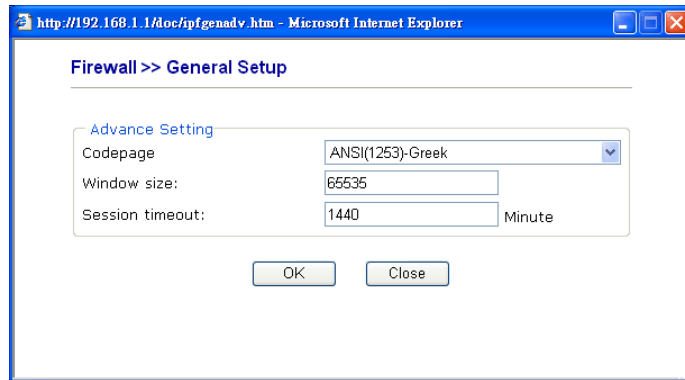

Codepage - This function is used to compare the characters among different languages. Choose correct codepage can help the system obtaining correct ASCII after decoding data from URL and enhance the correctness of URL Content Filter. The default value for this setting is ANSI 1252 Latin I. If you do not choose any codepage, no decoding job of URL will be processed. Please use the drop-down list to choose a codepage.

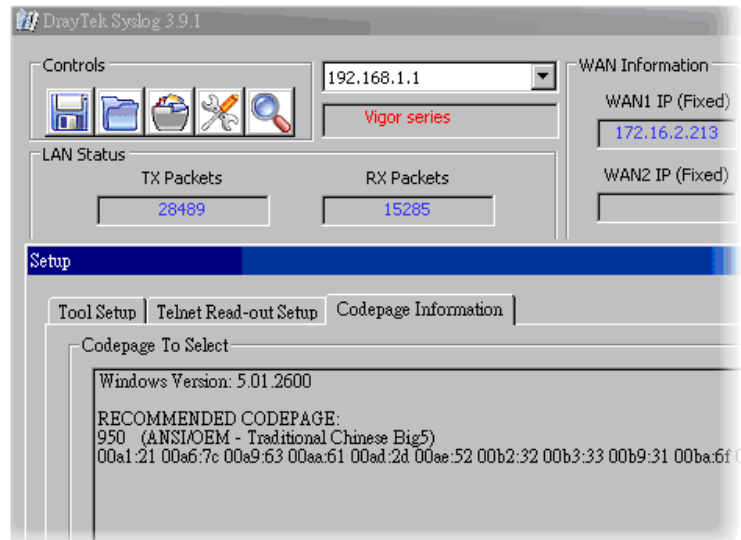

If you do not have any idea of choosing suitable codepage, please open Syslog. From Codepage Information of Setup dialog, you will see the recommended codepage listed on the dialog box.

Window size – It determines the size of TCP protocol (0~65535). The more the value is, the better the performance will be. However, if the network is not stable, small value will be proper.

Session timeout–Setting timeout for sessions can make the best utilization of network resources. However, Queue timeout is configured for TCP protocol only; session timeout is configured for the data flow which matched with the firewall rule.

Some on-line games (for example: Half Life) will use lots of fragmented UDP packets to transfer game data. Instinctively as a secure firewall, Vigor router will reject these fragmented packets to prevent attack unless you enable “**Accept Incoming Fragmented UDP Packets**”. By checking this box, you can play these kinds of on-line games. If security concern is in higher priority, you cannot enable “**Accept Incoming Fragmented UDP Packets**”.

5.4.3 Filter Setup

Click **Firewall** and click **Filter Setup** to open the setup page.

[Firewall >> Filter Setup](#)

Filter Setup		Set to Factory Default	
Set	Comments	Set	Comments
1.	Default Call Filter	7.	
2.	Default Data Filter	8.	
3.		9.	
4.		10.	
5.		11.	
6.		12.	

To edit or add a filter, click on the set number to edit the individual set. The following page will be shown. Each filter set contains up to 7 rules. Click on the rule number button to edit each rule. Check **Active** to enable the rule.

[Firewall >> Filter Setup >> Edit Filter Set](#)

Filter Set 1

Comments :

Filter Rule	Active	Comments	Move Up	Move Down
<input type="button" value="1"/>	<input checked="" type="checkbox"/>	Block NetBios		Down
<input type="button" value="2"/>	<input type="checkbox"/>		UP	Down
<input type="button" value="3"/>	<input type="checkbox"/>		UP	Down
<input type="button" value="4"/>	<input type="checkbox"/>		UP	Down
<input type="button" value="5"/>	<input type="checkbox"/>		UP	Down
<input type="button" value="6"/>	<input type="checkbox"/>		UP	Down
<input type="button" value="7"/>	<input type="checkbox"/>		UP	

Next Filter Set

Filter Rule	Click a button numbered (1 ~ 7) to edit the filter rule. Click the button will open Edit Filter Rule web page. For the detailed information, refer to the following page.
Active	Enable or disable the filter rule.
Comment	Enter filter set comments/description. Maximum length is 23-character long.
Move Up/Down	Use Up or Down link to move the order of the filter rules.
Next Filter Set	Set the link to the next filter set to be executed after the current filter run. Do not make a loop with many filter sets.

To edit **Filter Rule**, click the **Filter Rule** index button to enter the **Filter Rule** setup page.

[Firewall >> Edit Filter Set >> Edit Filter Rule](#)

Filter Set 1 Rule 1

Check to enable the Filter Rule

Comments:

Index(1-15) in [Schedule](#) Setup: , , ,

Direction:

Source IP:

Destination IP:

Service Type:

Fragments:

Application	Action/Profile	Syslog
Filter: <input type="text" value="Block Immediately"/>	<input type="text" value="Block Immediately"/>	<input type="checkbox"/>
Branch to Other Filter Set: <input type="text" value="None"/>	<input type="text" value="None"/>	<input type="checkbox"/>
APP Enforcement: <input type="text" value="None"/>	<input type="text" value="None"/>	<input type="checkbox"/>
URL Content Filter: <input type="text" value="None"/>	<input type="text" value="None"/>	<input type="checkbox"/>
Web Content Filter: <input type="text" value="None"/>	<input type="text" value="None"/>	<input type="checkbox"/>

Advance Setting

Check to enable the Filter Rule	Check this box to enable the filter rule.
Comments	Enter filter set comments/description. Maximum length is 14-character long.
Index(1-15)	Set PCs on LAN to work at certain time interval only. You may choose up to 4 schedules out of the 15 schedules pre-defined in Applications >> Schedule setup. The default setting of this filed is blank and the function will always work.
Direction	Set the direction of packet flow (LAN->WAN/WAN->LAN). It is for Data Filter only. For the Call Filter , this setting is not available since Call Filter is only applied to outgoing traffic.
Source/Destination IP	Click Edit to access into the following dialog to choose the source/destination IP or IP ranges.

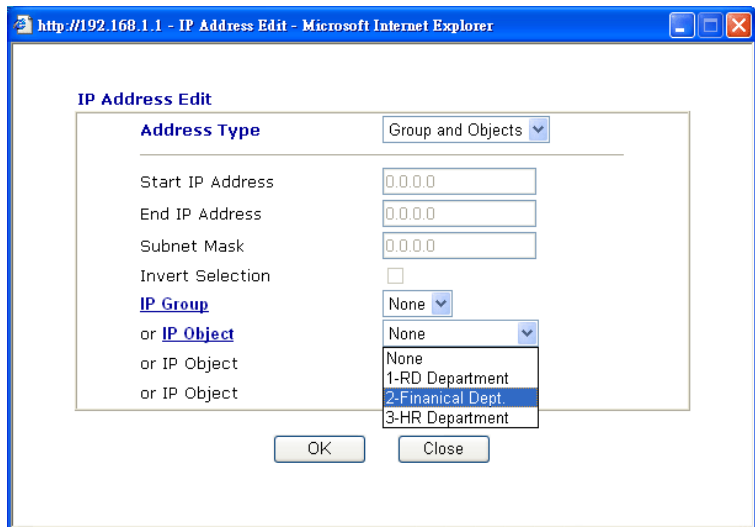

To set the IP address manually, please choose **Any Address/Single Address/Range Address/Subnet Address** as the Address Type and type them in this dialog. In addition, if you want to use the IP range from defined groups or objects, please choose **Group and Objects** as the Address Type.

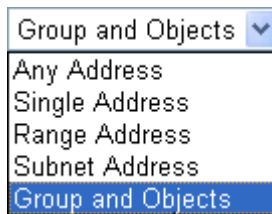

From the **IP Group** drop down list, choose the one that you want to apply. Or use the **IP Object** drop down list to choose the object that you want.

Service Type

Click **Edit** to access into the following dialog to choose a suitable service type.

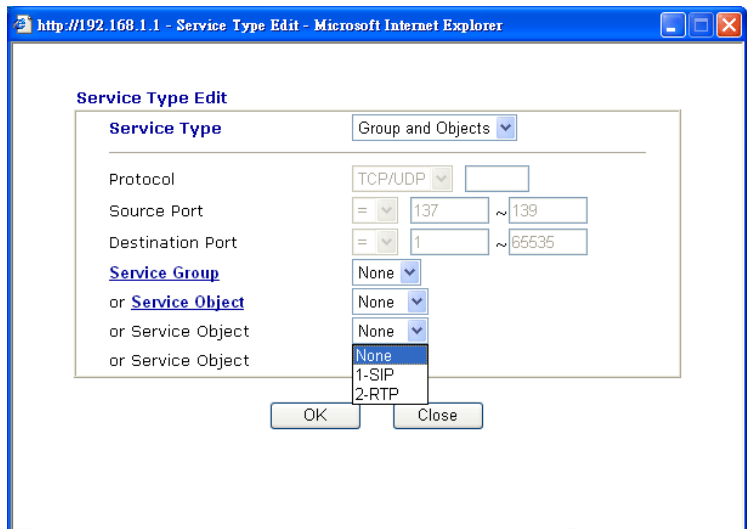

To set the service type manually, please choose **User defined** as the Service Type and type them in this dialog. In addition, if you want to use the service type from defined groups or objects, please choose **Group and Objects** as the Service

Type.

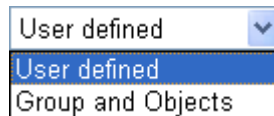

Protocol - Specify the protocol(s) which this filter rule will apply to.

Source/Destination Port -

(=) – when the first and last value are the same, it indicates one port; when the first and last values are different, it indicates a range for the port and available for this service type.

(! =) – when the first and last value are the same, it indicates all the ports except the port defined here; when the first and last values are different, it indicates that all the ports except the range defined here are available for this service type.

(>) – the port number greater than this value is available.

(<) – the port number less than this value is available for this profile.

Service Group/Object - Use the drop down list to choose the one that you want.

Fragments

Specify the action for fragmented packets. And it is used for **Data Filter** only.

Don't care -No action will be taken towards fragmented packets.

Unfragmented -Apply the rule to unfragmented packets.

Fragmented - Apply the rule to fragmented packets.

Too Short - Apply the rule only to packets that are too short to contain a complete header.

Filter

Specifies the action to be taken when packets match the rule.

Block Immediately - Packets matching the rule will be dropped immediately.

Pass Immediately - Packets matching the rule will be passed immediately.

Block If No Further Match - A packet matching the rule, and that does not match further rules, will be dropped.

Pass If No Further Match - A packet matching the rule, and that does not match further rules, will be passed through.

Branch to other Filter Set

If the packet matches the filter rule, the next filter rule will branch to the specified filter set. Select next filter rule to branch from the drop-down menu. Be aware that the router will apply the specified filter rule for ever and will not return to previous filter rule any more.

APP Enforcement

Select one of the **APP Enforcement Profile** settings (created in **CSM>> APP Enforcement Profile**) for applying with this router. Please set at least one profile for choosing in **CSM>>**

APP Enforcement Profile web page first. For troubleshooting needs, you can specify to record information for **APP Enforcement Profile** by checking the Log box. It will be sent to Syslog server. Please refer to section **System Maintenance>> Syslog/Mail Alert** for more detailed information.

URL Content Filter

Select one of the **URL Content Filter** profile settings (created in **CSM>> URL Content Filter**) for applying with this router. Please set at least one profile for choosing in **CSM>> URL Content Filter** web page first. For troubleshooting needs, you can specify to record information for **URL Content Filter** by checking the Log box. It will be sent to Syslog server. Please refer to section **System Maintenance>> Syslog/Mail Alert** for more detailed information.

Web Content Filter

Select one of the **Web Content Filter** profile settings (created in **CSM>> Web Content Filter**) for applying with this router. Please set at least one profile for anti-virus in **CSM>> Web Content Filter** web page first. For troubleshooting needs, you can specify to record information for **Web Content Filter** by checking the Log box. It will be sent to Syslog server. Please refer to section **System Maintenance>> Syslog/Mail Alert** for more detailed information.

SysLog

For troubleshooting needs you can specify the filter log and/or CSM log here. Check the corresponding box to enable the log function. Then, the filter log and/or CSM log will be shown on Draytek Syslog window.

Advance Setting

Click **Edit** to open the following window. However, it is **strongly recommended** to use the default settings here.

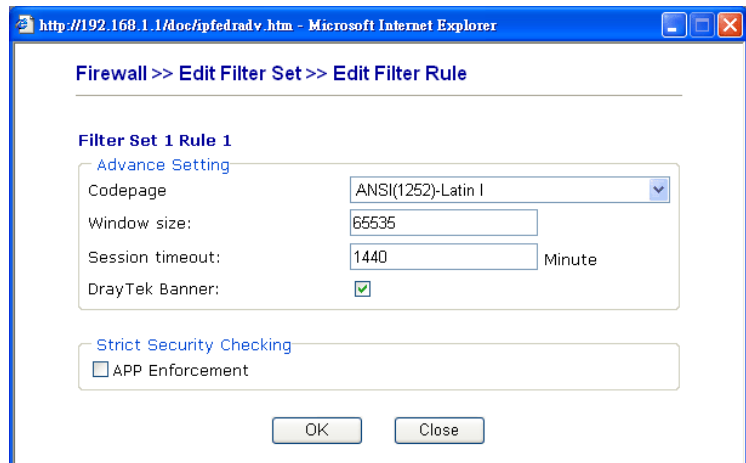

Codepage - This function is used to compare the characters among different languages. Choose correct codepage can help the system obtaining correct ASCII after decoding data from URL and enhance the correctness of URL Content Filter. The default value for this setting is ANSI 1252 Latin I. If you do not choose any codepage, no decoding job of URL will be processed. Please use the drop-down list to choose a codepage.

If you do not have any idea of choosing suitable codepage, please open Syslog. From Codepage Information of Setup dialog, you will see the recommended codepage listed on the

dialog box.

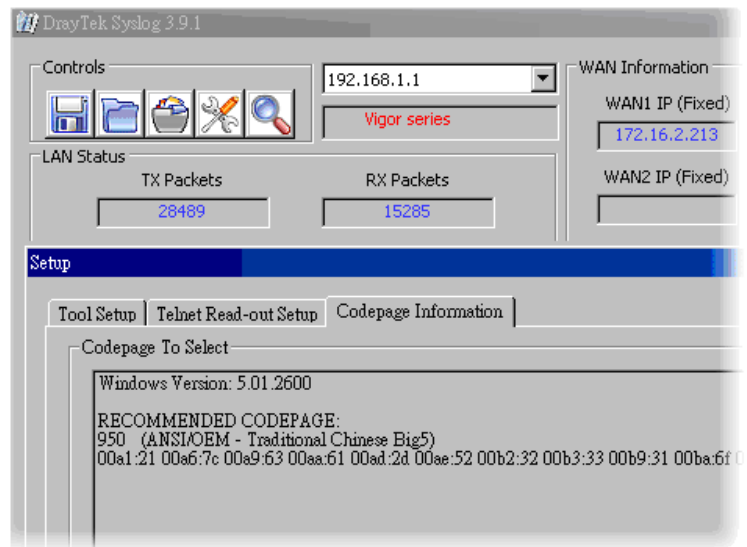

Window size – It determines the size of TCP protocol (0~65535). The more the value is, the better the performance will be. However, if the network is not stable, small value will be proper.

Session timeout–Setting timeout for sessions can make the best utilization of network resources. However, Queue timeout is configured for TCP protocol only; session timeout is configured for the data flow which matched with the firewall rule.

DrayTek Banner – Please uncheck this box and the following screen will not be shown for the unreachable web page. The default setting is Enabled.

Strict Security Checking - All the packets, while transmitting through Vigor router, will be filtered by firewall settings configured by Vigor router if Strict Security Firewall is enabled. If the firewall system does not have any response (pass or block) for these packets, such as no response coming from Anti-Spam server, then the router's firewall will block the packets directly.

In addition, you can restrict the strict security checking just be done by specified server and conditions such as Anti-Virus, Anti-Spam, In-Sequence and APP Enforcement. Thus, the packets not only must be filtered by general rules by Firewall, but also must be filtered by the items selected in Strict Security Checking. Such work can ensure the data security transferring via network.

APP Enforcement – Check this box to execute the critical checking for all the files transferred via IM/P2P.

Example

As stated before, all the traffic will be separated and arbitrated using one of two IP filters: call filter or data filter. You may preset 12 call filters and data filters in **Filter Setup** and even link them in a serial manner. Each filter set is composed by 7 filter rules, which can be further defined. After that, in **General Setup** you may specify one set for call filter and one set for data filter to execute first.

The screenshots illustrate the configuration process:

- Firewall >> General Setup:** Shows the 'General Setup' section with 'Start Filter Set' dropdowns for 'Call Filter' (Set#1) and 'Data Filter' (Set#2). Below are 'Actions for default rule' for Application, Filter, APP Enforcement, URL Content Filter, and Web Content Filter. An 'Advance Setting' button is also present.
- Firewall >> Filter Setup:** Displays a table of filter sets. A red box highlights the 'Set' column.
- Firewall >> Filter Setup >> Edit Filter Set:** Shows a table of filter rules for 'Filter Set 1'. A red box highlights rule 1.
- Firewall >> Filter Setup >> Edit Filter Set >> Edit Filter Rule:** Shows the configuration for 'Filter Set 1 Rule 1', including direction (LAN -> WAN), source/destination IP (Any), service type (TCP/UDP), and application settings (Block Immediately).

Set	Comments	Set	Comments
1	Default Call Filter	7	
2	Default Data Filter	8	
3		9	
4		10	
5		11	
6		12	

Filter Rule	Active	Comments	Move Up	Move Down
1	<input checked="" type="checkbox"/>	Block NetBios		Down
2	<input type="checkbox"/>		UP	Down
3	<input type="checkbox"/>		UP	Down
4	<input type="checkbox"/>		UP	Down
5	<input type="checkbox"/>		UP	Down
6	<input type="checkbox"/>		UP	Down
7	<input type="checkbox"/>		UP	Down

5.4.4 DoS Defense

As a sub-functionality of IP Filter/Firewall, there are 15 types of detect/ defense function in the **DoS Defense** setup. The DoS Defense functionality is disabled for default.

Click **Firewall** and click **DoS Defense** to open the setup page.

[Firewall >> DoS defense Setup](#)

DoS defense Setup

Enable DoS Defense

<input type="checkbox"/> Enable SYN flood defense	Threshold	<input type="text" value="50"/>	packets / sec
	Timeout	<input type="text" value="10"/>	sec
<input type="checkbox"/> Enable UDP flood defense	Threshold	<input type="text" value="150"/>	packets / sec
	Timeout	<input type="text" value="10"/>	sec
<input type="checkbox"/> Enable ICMP flood defense	Threshold	<input type="text" value="50"/>	packets / sec
	Timeout	<input type="text" value="10"/>	sec
<input type="checkbox"/> Enable Port Scan detection	Threshold	<input type="text" value="150"/>	packets / sec

Block IP options Block TCP flag scan
 Block Land Block Tear Drop
 Block Smurf Block Ping of Death
 Block trace route Block ICMP fragment
 Block SYN fragment Block UnknownProtocol
 Block Fraggle Attack

Enable DoS defense function to prevent the attacks from hacker or crackers.

OK Clear All Cancel

Enable Dos Defense

Check the box to activate the DoS Defense Functionality.

Enable SYN flood defense

Check the box to activate the SYN flood defense function. Once detecting the Threshold of the TCP SYN packets from the Internet has exceeded the defined value, the Vigor router will start to randomly discard the subsequent TCP SYN packets for a period defined in Timeout. The goal for this is prevent the TCP SYN packets' attempt to exhaust the limited-resource of Vigor router. By default, the threshold and timeout values are set to 50 packets per second and 10 seconds, respectively.

Enable UDP flood defense

Check the box to activate the UDP flood defense function. Once detecting the Threshold of the UDP packets from the Internet has exceeded the defined value, the Vigor router will start to randomly discard the subsequent UDP packets for a period defined in Timeout. The default setting for threshold and timeout are 150 packets per second and 10 seconds, respectively.

Enable ICMP flood defense

Check the box to activate the ICMP flood defense function. Similar to the UDP flood defense function, once if the Threshold of ICMP packets from Internet has exceeded the defined value, the router will discard the ICMP echo requests coming from the Internet. The default setting for threshold and timeout are 50 packets per second and 10 seconds, respectively.

Enable PortScan detection	Port Scan attacks the Vigor router by sending lots of packets to many ports in an attempt to find ignorant services would respond. Check the box to activate the Port Scan detection. Whenever detecting this malicious exploration behavior by monitoring the port-scanning Threshold rate, the Vigor router will send out a warning. By default, the Vigor router sets the threshold as 150 packets per second.
Block IP options	Check the box to activate the Block IP options function. The Vigor router will ignore any IP packets with IP option field in the datagram header. The reason for limitation is IP option appears to be a vulnerability of the security for the LAN because it will carry significant information, such as security, TCC (closed user group) parameters, a series of Internet addresses, routing messages...etc. An eavesdropper outside might learn the details of your private networks.
Block Land	Check the box to enforce the Vigor router to defense the Land attacks. The Land attack combines the SYN attack technology with IP spoofing. A Land attack occurs when an attacker sends spoofed SYN packets with the identical source and destination addresses, as well as the port number to victims.
Block Smurf	Check the box to activate the Block Smurf function. The Vigor router will ignore any broadcasting ICMP echo request.
Block trace router	Check the box to enforce the Vigor router not to forward any trace route packets.
Block SYN fragment	Check the box to activate the Block SYN fragment function. The Vigor router will drop any packets having SYN flag and more fragment bit set.
Block Fraggle Attack	Check the box to activate the Block fraggle Attack function. Any broadcast UDP packets received from the Internet is blocked. Activating the DoS/DDoS defense functionality might block some legal packets. For example, when you activate the fraggle attack defense, all broadcast UDP packets coming from the Internet are blocked. Therefore, the RIP packets from the Internet might be dropped.
Block TCP flag scan	Check the box to activate the Block TCP flag scan function. Any TCP packet with anomaly flag setting is dropped. Those scanning activities include <i>no flag scan</i> , <i>FIN without ACK scan</i> , <i>SYN FINscan</i> , <i>Xmas scan</i> and <i>full Xmas scan</i> .
Block Tear Drop	Check the box to activate the Block Tear Drop function. Many machines may crash when receiving ICMP datagrams (packets) that exceed the maximum length. To avoid this type of attack, the Vigor router is designed to be capable of discarding any fragmented ICMP packets with a length greater than 1024 octets.
Block Ping of Death	Check the box to activate the Block Ping of Death function. This attack involves the perpetrator sending overlapping packets to the target hosts so that those target hosts will hang once they re-construct the packets. The Vigor routers will

block any packets realizing this attacking activity.

Block ICMP Fragment

Check the box to activate the Block ICMP fragment function. Any ICMP packets with more fragment bit set are dropped.

Block Unknown Protocol

Check the box to activate the Block Unknown Protocol function. Individual IP packet has a protocol field in the datagram header to indicate the protocol type running over the upper layer. However, the protocol types greater than 100 are reserved and undefined at this time. Therefore, the router should have ability to detect and reject this kind of packets.

Warning Messages

We provide Syslog function for user to retrieve message from Vigor router. The user, as a Syslog Server, shall receive the report sending from Vigor router which is a Syslog Client.

All the warning messages related to **DoS Defense** will be sent to user and user can review it through Syslog daemon. Look for the keyword **DoS** in the message, followed by a name to indicate what kind of attacks is detected.

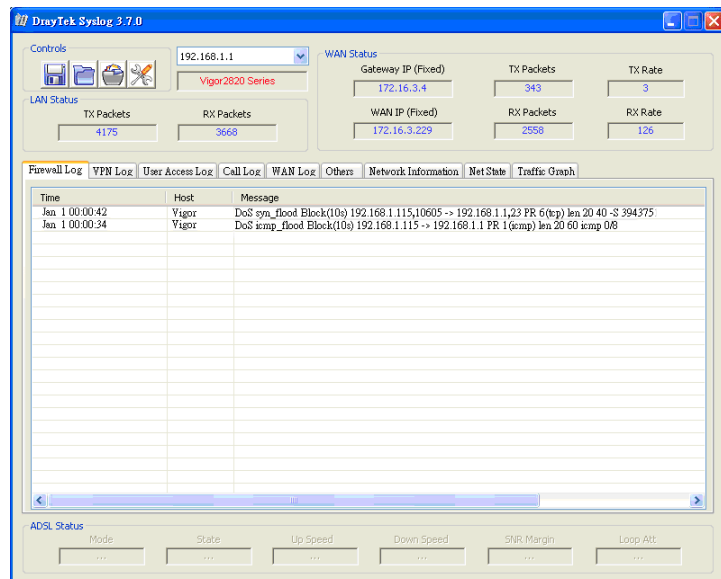
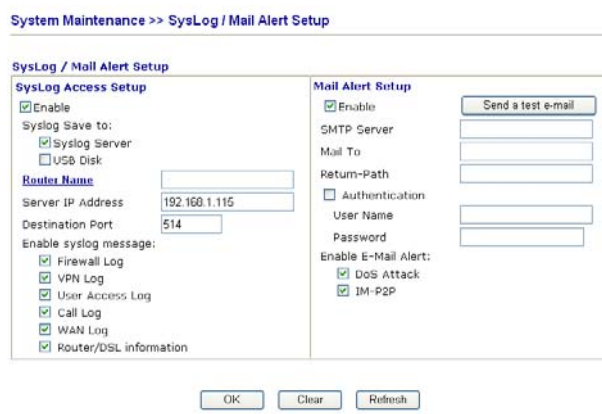

5.5 Objects Settings

For IPs in a range and service ports in a limited range usually will be applied in configuring router's settings, therefore we can define them with *objects* and bind them with *groups* for using conveniently. Later, we can select that object/group that can apply it. For example, all the IPs in the same department can be defined with an IP object (a range of IP address).

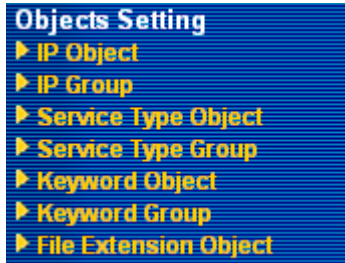

5.5.1 IP Object

You can set up to 192 sets of IP Objects with different conditions.

[Objects Setting >> IP Object](#)

IP Object Profiles: [Set to Factory Default](#)

Index	Name	Index	Name
1.		17.	
2.		18.	
3.		19.	
4.		20.	
5.		21.	
6.		22.	
7.		23.	
8.		24.	
9.		25.	
10.		26.	
11.		27.	
12.		28.	
13.		29.	
14.		30.	
15.		31.	
16.		32.	

<< [1-32](#) | [33-64](#) | [65-96](#) | [97-128](#) | [129-160](#) | [161-192](#) >> [Next](#) >>

Set to Factory Default Clear all profiles.

Click the number under Index column for settings in detail.

[Objects Setting >> IP Object](#)

Profile Index : 1

Name:	<input type="text" value="RD Department"/>
Interface:	<input type="text" value="Any"/>
Address Type:	<input type="text" value="Range Address"/>
Start IP Address:	<input type="text" value="192.168.1.64"/>
End IP Address:	<input type="text" value="192.168.1.75"/>
Subnet Mask:	<input type="text" value="0.0.0.0"/>
Invert Selection:	<input type="checkbox"/>

Name Type a name for this profile. Maximum 15 characters are

allowed.

Interface

Choose a proper interface (WAN, LAN or Any).

Interface:

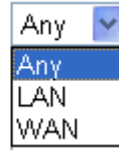

For example, the **Direction** setting in **Edit Filter Rule** will ask you specify IP or IP range for WAN or LAN or any IP address. If you choose LAN as the **Interface** here, and choose LAN as the direction setting in **Edit Filter Rule**, then all the IP addresses specified with LAN interface will be opened for you to choose in **Edit Filter Rule** page.

Address Type

Determine the address type for the IP address.

Select **Single Address** if this object contains one IP address only.

Select **Range Address** if this object contains several IPs within a range.

Select **Subnet Address** if this object contains one subnet for IP address.

Select **Any Address** if this object contains any IP address.

Start IP Address

Type the start IP address for Single Address type.

End IP Address

Type the end IP address if the Range Address type is selected.

Subnet Mask

Type the subnet mask if the Subnet Address type is selected.

Invert Selection

If it is checked, all the IP addresses except the ones listed above will be applied later while it is chosen.

Below is an example of IP objects settings.

Objects Setting >> IP Object

IP Object Profiles:

Index	Name
1.	RD Department
2.	Finanical Dept.
3.	HR Department
4.	

5.5.2 IP Group

This page allows you to bind several IP objects into one IP group.

[Objects Setting >> IP Group](#)

IP Group Table: [Set to Factory Default](#)

Index	Name	Index	Name
1.		17.	
2.		18.	
3.		19.	
4.		20.	
5.		21.	
6.		22.	
7.		23.	
8.		24.	
9.		25.	
10.		26.	
11.		27.	
12.		28.	
13.		29.	
14.		30.	
15.		31.	
16.		32.	

Set to Factory Default Clear all profiles.

Click the number under Index column for settings in detail.

[Objects Setting >> IP Group](#)

Profile Index : 1

Name:

Interface: ▾

Available IP Objects

1-RD Department
 2-Finanical Dept.
 3-HR Department

Selected IP Objects

(Empty)

Name Type a name for this profile. Maximum 15 characters are allowed.

Interface Choose WAN, LAN or Any to display all the available IP objects with the specified interface.

Available IP Objects All the available IP objects with the specified interface chosen above will be shown in this box.

Selected IP Objects Click >> button to add the selected IP objects in this box.

5.5.3 Service Type Object

You can set up to 96 sets of Service Type Objects with different conditions.

[Objects Setting >> Service Type Object](#)

Service Type Object Profiles: [Set to Factory Default](#)

Index	Name	Index	Name
1.		17.	
2.		18.	
3.		19.	
4.		20.	
5.		21.	
6.		22.	
7.		23.	
8.		24.	
9.		25.	
10.		26.	
11.		27.	
12.		28.	
13.		29.	
14.		30.	
15.		31.	
16.		32.	

<< [1-32](#) | [33-64](#) | [65-96](#) >> [Next >>](#)

Set to Factory Default Clear all profiles.

Click the number under Index column for settings in detail.

[Objects Setting >> Service Type Object Setup](#)

Profile Index : 1

Name	<input type="text" value="www"/>
Protocol	TCP <input type="text" value="6"/>
Source Port	= <input type="text" value="1"/> ~ <input type="text" value="65535"/>
Destination Port	= <input type="text" value="70"/> ~ <input type="text" value="80"/>

Name Type a name for this profile.

Protocol Specify the protocol(s) which this profile will apply to.

TCP	<input type="text" value="6"/>
-----	--------------------------------

- Any
- ICMP
- IGMP
- TCP
- UDP
- TCP/UDP
- Other

Source/Destination Port **Source Port** and the **Destination Port** column are available for TCP/UDP protocol. It can be ignored for other protocols. The filter rule will filter out any port number.

(=) – when the first and last value are the same, it indicates one port; when the first and last values are different, it indicates a range for the port and available for this profile.

(! =) – when the first and last value are the same, it indicates all the ports except the port defined here; when the first and last values are different, it indicates that all the ports except the range defined here are available for this service type.

(>) – the port number greater than this value is available.

(<) – the port number less than this value is available for this profile.

Below is an example of service type objects settings.

Service Type Object Profiles:

Index	Name
1.	SIP
2.	RTP
3.	
4.	

5.5.4 Service Type Group

This page allows you to bind several service types into one group.

[Objects Setting >> Service Type Group](#)

Service Type Group Table:

[Set to Factory Default](#)

Group	Name	Group	Name
1.		17.	
2.		18.	
3.		19.	
4.		20.	
5.		21.	
6.		22.	
7.		23.	
8.		24.	
9.		25.	
10.		26.	
11.		27.	
12.		28.	
13.		29.	
14.		30.	
15.		31.	
16.		32.	

Set to Factory Default Clear all profiles.

Click the number under Index column for settings in detail.

[Objects Setting >> Service Type Group Setup](#)

Profile Index : 1

Name:

Available Service Type Objects	Selected Service Type Objects
1-SIP 2-RTP	

- Name** Type a name for this profile.
- Available Service Type Objects** All the available service objects that you have added on **Objects Setting>>Service Type Object** will be shown in this box.
- Selected Service Type Objects** Click button to add the selected IP objects in this box.

5.5.5 Keyword Object

You can set 200 keyword object profiles for choosing as black /white list in **CSM >>URL Web Content Filter Profile**.

[Objects Setting >> Keyword Object](#)

Keyword Object Profiles: [Set to Factory Default](#)

Index	Name	Index	Name
1.		17.	
2.		18.	
3.		19.	
4.		20.	
5.		21.	
6.		22.	
7.		23.	
8.		24.	
9.		25.	
10.		26.	
11.		27.	
12.		28.	
13.		29.	
14.		30.	
15.		31.	
16.		32.	

<< [1-32](#) | [33-64](#) | [65-96](#) | [97-128](#) | [129-160](#) | [161-192](#) | [193-200](#) >>
[Next](#) >>

- Set to Factory Default** Clear all profiles.
- Click the number under Index column for setting in detail.

Objects Setting >> Keyword Object Setup

Profile Index : 13

Name	<input type="text"/>
Contents	<input type="text"/>
Limit of Contents: Max 3 Words and 63 Characters. Each word should be separated by a single space.	
You can replace a character with %HEX. Example: Contents: backdoo%72 virus keep%20out	
Result: 1. backdoor 2. virus 3. keep out	

Name Type a name for this profile, e.g., game.

Contents Type the content for such profile. For example, type *gambling* as Contents. When you browse the webpage, the page with gambling information will be watched out and be passed/blocked based on the configuration on Firewall settings.

5.5.6 Keyword Group

This page allows you to bind several keyword objects into one group. The keyword groups set here will be chosen as black /white list in **CSM >>URL Web Content Filter Profile**.

Objects Setting >> Keyword Group

Keyword Group Table:

[Set to Factory Default](#)

Index	Name	Index	Name
1.		17.	
2.		18.	
3.		19.	
4.		20.	
5.		21.	
6.		22.	
7.		23.	
8.		24.	
9.		25.	
10.		26.	
11.		27.	
12.		28.	
13.		29.	
14.		30.	
15.		31.	
16.		32.	

Set to Factory Default Clear all profiles.

Click the number under Index column for setting in detail.

Profile Index : 1

Name:

Available Keyword Objects

1-Keyword-1
2-keyword-2

>>

<<

Selected Keyword Objects(Max 16 Objects)

- Name** Type a name for this group.
- Available Keyword Objects** You can gather keyword objects from Keyword Object page within one keyword group. All the available Keyword objects that you have created will be shown in this box.
- Selected Keyword Objects** Click button to add the selected Keyword objects in this box.

5.5.7 File Extension Object

This page allows you to set eight profiles which will be applied in **CSM>>URL Content Filter**. All the files with the extension names specified in these profiles will be processed according to the chosen action.

File Extension Object Profiles: [Set to Factory Default](#)

Profile	Name	Profile	Name
1.		5.	
2.		6.	
3.		7.	
4.		8.	

- Set to Factory Default** Clear all profiles.
- Click the number under Profile column for configuration in details.

Objects Setting >> File Extension Object Setup

Profile Index: 1 Profile Name:

Categories	File Extensions
Image <input type="button" value="Select All"/> <input type="button" value="Clear All"/>	<input type="checkbox"/> .bmp <input type="checkbox"/> .dib <input type="checkbox"/> .gif <input type="checkbox"/> .jpeg <input type="checkbox"/> .jpg <input type="checkbox"/> .jpg2 <input type="checkbox"/> .jp2 <input type="checkbox"/> .pct <input type="checkbox"/> .pcx <input type="checkbox"/> .pic <input type="checkbox"/> .pict <input type="checkbox"/> .png <input type="checkbox"/> .tif <input type="checkbox"/> .tiff
Video <input type="button" value="Select All"/> <input type="button" value="Clear All"/>	<input type="checkbox"/> .asf <input type="checkbox"/> .avi <input type="checkbox"/> .mov <input type="checkbox"/> .mpe <input type="checkbox"/> .mpeg <input type="checkbox"/> .mpg <input type="checkbox"/> .mp4 <input type="checkbox"/> .qt <input type="checkbox"/> .rm <input type="checkbox"/> .wmv <input type="checkbox"/> .3gp <input type="checkbox"/> .3gpp <input type="checkbox"/> .3gpp2 <input type="checkbox"/> .3g2
Audio <input type="button" value="Select All"/> <input type="button" value="Clear All"/>	<input type="checkbox"/> .aac <input type="checkbox"/> .aiff <input type="checkbox"/> .au <input type="checkbox"/> .mp3 <input type="checkbox"/> .m4a <input type="checkbox"/> .m4p <input type="checkbox"/> .ogg <input type="checkbox"/> .ra <input type="checkbox"/> .ram <input type="checkbox"/> .vox <input type="checkbox"/> .wav <input type="checkbox"/> .wma
Java <input type="button" value="Select All"/> <input type="button" value="Clear All"/>	<input type="checkbox"/> .class <input type="checkbox"/> .jad <input type="checkbox"/> .jar <input type="checkbox"/> .jav <input type="checkbox"/> .java <input type="checkbox"/> .jcm <input type="checkbox"/> .js <input type="checkbox"/> .jse <input type="checkbox"/> .jsp <input type="checkbox"/> .jtk
ActiveX <input type="button" value="Select All"/> <input type="button" value="Clear All"/>	<input type="checkbox"/> .alx <input type="checkbox"/> .apb <input type="checkbox"/> .axs <input type="checkbox"/> .ocx <input type="checkbox"/> .olb <input type="checkbox"/> .ole <input type="checkbox"/> .tlb <input type="checkbox"/> .viv <input type="checkbox"/> .vrm
Compression <input type="button" value="Select All"/> <input type="button" value="Clear All"/>	<input type="checkbox"/> .ace <input type="checkbox"/> .arj <input type="checkbox"/> .bzip2 <input type="checkbox"/> .bz2 <input type="checkbox"/> .cab <input type="checkbox"/> .gz <input type="checkbox"/> .gzip <input type="checkbox"/> .rar <input type="checkbox"/> .sit <input type="checkbox"/> .zip
Execution <input type="button" value="Select All"/> <input type="button" value="Clear All"/>	<input type="checkbox"/> .bas <input type="checkbox"/> .bat <input type="checkbox"/> .com <input type="checkbox"/> .exe <input type="checkbox"/> .inf <input type="checkbox"/> .pif <input type="checkbox"/> .reg <input type="checkbox"/> .scr

Profile Name Type a name for this profile.

Type a name for such profile and check all the items of file extension that will be processed in the router. Finally, click **OK** to save this profile.

5.6 CSM

CSM is an abbreviation of **Content Security Management** which is used to control APP enforcement, filter the web content and URL content to reach a goal of security management.

APP Enforcement

As the popularity of all kinds of instant messenger application arises, communication cannot become much easier. Nevertheless, while some industry may leverage this as a great tool to connect with their customers, some industry may take reserve attitude in order to reduce employee misuse during office hour or prevent unknown security leak. It is similar situation for corporation towards peer-to-peer applications since file-sharing can be convenient but insecure at the same time. To address these needs, we provide CSM functionality.

URL Content Filter

To provide an appropriate cyberspace to users, Vigor router equips with **URL Content Filter** not only to limit illegal traffic from/to the inappropriate web sites but also prohibit other web feature where malicious code may conceal.

Once a user type in or click on an URL with objectionable keywords, URL keyword blocking facility will decline the HTTP request to that web page thus can limit user's access to the website. You may imagine **URL Content Filter** as a well-trained convenience-store clerk who won't sell adult magazines to teenagers. At office, **URL Content Filter** can also provide a job-related only environment hence to increase the employee work efficiency. How can URL Content Filter work better than traditional firewall in the field of filtering? Because it checks the URL strings or some of HTTP data hiding in the payload of TCP packets while legacy firewall inspects packets based on the fields of TCP/IP headers only.

On the other hand, Vigor router can prevent user from accidentally downloading malicious codes from web pages. It's very common that malicious codes conceal in the executable objects, such as ActiveX, Java Applet, compressed files, and other executable files. Once downloading these types of files from websites, you may risk bringing threat to your system. For example, an ActiveX control object is usually used for providing interactive web feature. If malicious code hides inside, it may occupy user's system.

Web Content Filter

We all know that the content on the Internet just like other types of media may be inappropriate sometimes. As a responsible parent or employer, you should protect those in your trust against the hazards. With Web filtering service of the Vigor router, you can protect your business from common primary threats, such as productivity, legal liability, network and security threats. For parents, you can protect your children from viewing adult websites or chat rooms.

Once you have activated your Web Filtering service in Vigor router and chosen the categories of website you wish to restrict, each URL address requested (e.g. www.bbc.co.uk) will be checked against our server database. This database is updated as frequent as daily by a global team of Internet researchers. The server will look up the URL and return a category to your router. Your Vigor router will then decide whether to allow access to this site according to the categories you have selected. Please note that this action will not introduce any delay in your Web surfing because each of multiple load balanced database servers can handle millions of requests for categorization.

Note: The priority of URL Content Filter is higher than Web Content Filter.

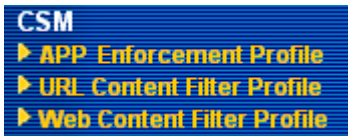

5.6.1 APP Enforcement Profile

You can define policy profiles for different policy of IM (Instant Messenger)/P2P (Peer to Peer)/Protocol and miscellaneous application. Such profile will be used in **Firewall>>General Setup** and **Firewall>>Filter Setup** pages.

[CSM >> APP Enforcement Profile](#)

APP Enforcement Profile Table: [Set to Factory Default](#)

Profile	Name	Profile	Name
1.		17.	
2.		18.	
3.		19.	
4.		20.	
5.		21.	
6.		22.	
7.		23.	
8.		24.	
9.		25.	
10.		26.	
11.		27.	
12.		28.	
13.		29.	
14.		30.	
15.		31.	
16.		32.	

- Set to Factory Default** Clear all profiles.
- Profile** Display the number of the profile which allows you to click to set different policy.
- Name** Display the name of the APP Enforcement Profile.

Click the number under Index column for settings in detail.

There are four tabs IM, P2P, Protocol and Misc displayed on this page. Each tab will bring out different items that you can choose to disallow people using.

Below shows the items which are categorized under **Protocol**.

CSM >> APP Enforcement Profile

Profile Index : 1 Profile Name: Action: ▾

IM	P2P	Protocol	Misc	
<input type="button" value="Select All"/>				
Protocol				
<input type="checkbox"/> DNS	<input type="checkbox"/> FTP	<input type="checkbox"/> HTTP	<input type="checkbox"/> IMAP	<input type="checkbox"/> IRC
<input type="checkbox"/> NNTP	<input type="checkbox"/> POP3	<input type="checkbox"/> SMB	<input type="checkbox"/> SMTP	<input type="checkbox"/> SNMP
<input type="checkbox"/> SSH	<input type="checkbox"/> SSL/TLS	<input type="checkbox"/> TELNET	<input type="checkbox"/> MSSQL	<input type="checkbox"/> MySQL
<input type="checkbox"/> Oracle	<input type="checkbox"/> PostgreSQL	<input type="checkbox"/> Sybase	<input type="checkbox"/> DB2	<input type="checkbox"/> Informix

Profile Name Type a name for the CSM profile.

Action **Block** – All the items selected in this page will be blocked. Users will not access into related web pages or use the applications.

Pass – All the items selected in this page will not be blocked. User can access into related web pages or use the applications.

Select All Click it to choose all of the items in this page.

The profiles configured here can be applied in the **Firewall>>General Setup** and **Firewall>>Filter Setup** pages as the standard for the host(s) to follow.

The items categorized under **P2P** -----

CSM >> APP Enforcement Profile

Profile Index : 1 Profile Name: Action: ▾

IM	P2P	Protocol	Misc
<input type="button" value="Select All"/>			
		Protocol	Applications
		<input type="checkbox"/> SoulSeek	SoulSeek
		<input type="checkbox"/> eDonkey	eDonkey, eMule, Shareaza
		<input type="checkbox"/> FastTrack	KazaA, BearShare, iMesh
		<input type="checkbox"/> OpenFT	KCeasy, FilePipe
		<input type="checkbox"/> Gnutella	BearShare, Limewire, Shareaza, Foxy, KCeasy
		<input type="checkbox"/> OpenNap	Lopster, XNap, WinLop
		<input type="checkbox"/> BitTorrent	BitTorrent, BitSpirit, BitComet
		<input type="checkbox"/> Winny	Winny, WinMX, Share
Other P2P Applications			
<input type="checkbox"/> Xunlei	<input type="checkbox"/> Vagaa	<input type="checkbox"/> PP365	<input type="checkbox"/> POCO <input type="checkbox"/> Clubbox
<input type="checkbox"/> Ares	<input type="checkbox"/> ezPeer	<input type="checkbox"/> Pando	<input type="checkbox"/> Huntmine <input type="checkbox"/> Kuwo

Below shows the items which are categorized under **IM**.

CSM >> APP Enforcement Profile

Profile Index : 1 Profile Name: Action: **Block** ▼

IM	P2P	Protocol	Misc
----	-----	----------	------

Select All

Advanced Management				
Activity / Application	MSN	YahooIM	AIM(<= v5.9)	ICQ
Login	<input type="checkbox"/>	<input type="checkbox"/>	<input type="checkbox"/>	<input type="checkbox"/>
Message	<input type="checkbox"/>	<input type="checkbox"/>	<input type="checkbox"/>	<input type="checkbox"/>
File Transfer	<input type="checkbox"/>	<input type="checkbox"/>	<input type="checkbox"/>	<input type="checkbox"/>
Game	<input type="checkbox"/>	<input type="checkbox"/>	<input type="checkbox"/>	<input type="checkbox"/>
Conference(Video/Voice)	<input type="checkbox"/>	<input type="checkbox"/>	<input type="checkbox"/>	<input type="checkbox"/>
Other Activities	<input type="checkbox"/>	<input type="checkbox"/>		<input type="checkbox"/>

IM Application				VoIP
<input type="checkbox"/> AIM6	<input type="checkbox"/> QQ	<input type="checkbox"/> iChat	<input type="checkbox"/> Jabber/GoogleTalk	<input type="checkbox"/> Skype
<input type="checkbox"/> GoogleChat	<input type="checkbox"/> XFire	<input type="checkbox"/> GaduGadu	<input type="checkbox"/> Paltalk	<input type="checkbox"/> Kubao
<input type="checkbox"/> Qnext	<input type="checkbox"/> POCO/PP365	<input type="checkbox"/> AresChat	<input type="checkbox"/> AliWW	<input type="checkbox"/> Gizmo
<input type="checkbox"/> KC	<input type="checkbox"/> Lava-Lava	<input type="checkbox"/> ICU2	<input type="checkbox"/> iSpQ	<input type="checkbox"/> SIP
<input type="checkbox"/> UC	<input type="checkbox"/> MobileMSN	<input type="checkbox"/> BaiduHi		<input type="checkbox"/> TelTel

Web IM (* = more than one address)				
<input type="checkbox"/> WebIM URLs	eMessenger	WebMSN	meebo*	eBuddy
	ICQ Java*	ICQ Flash*	goowy*	IMhaha*
	IMUnitive*	Wablet*	mabber*	MSN2GO*
	MessengerFX*	MessengerAdictos	WebYahooIM	ILoveIM*
				getMessenger
				KoolIM

OK Cancel

The items categorized under **Misc** -----

CSM >> APP Enforcement Profile

Profile Index : 1 Profile Name: Action: **Block** ▼

IM	P2P	Protocol	Misc
----	-----	----------	------

Select All

Tunneling				
<input type="checkbox"/> Socks4/5	<input type="checkbox"/> PGPNet	<input type="checkbox"/> HTTP Proxy	<input type="checkbox"/> Tor	<input type="checkbox"/> VNN
<input type="checkbox"/> SoftEther	<input type="checkbox"/> MS TEREDO	<input type="checkbox"/> Wujie/UltraSurf	<input type="checkbox"/> Hamachi	<input type="checkbox"/> HTTP Tunnel
<input type="checkbox"/> Ping Tunnel	<input type="checkbox"/> TinyVPN	<input type="checkbox"/> RealTunnel	<input type="checkbox"/> DynaPass	<input type="checkbox"/> UltraVPN
<input type="checkbox"/> FreeU	<input type="checkbox"/> Skyfire			

Streaming				
<input type="checkbox"/> MMS	<input type="checkbox"/> RTSP	<input type="checkbox"/> TVAnts	<input type="checkbox"/> PPStream	<input type="checkbox"/> PPlive
<input type="checkbox"/> FeiDian	<input type="checkbox"/> UUsee	<input type="checkbox"/> NSPlayer	<input type="checkbox"/> PCAST	<input type="checkbox"/> TVKoo
<input type="checkbox"/> SopCast	<input type="checkbox"/> UDLiveX	<input type="checkbox"/> TVUPlayer	<input type="checkbox"/> MySee	<input type="checkbox"/> Joost
<input type="checkbox"/> FlashVideo	<input type="checkbox"/> SilverLight	<input type="checkbox"/> Slingbox	<input type="checkbox"/> QVOD	

Remote Control				
<input type="checkbox"/> VNC	<input type="checkbox"/> Radmin	<input type="checkbox"/> SpyAnywhere	<input type="checkbox"/> ShowMyPC	<input type="checkbox"/> LogMeIn
<input type="checkbox"/> TeamViewer	<input type="checkbox"/> Gogrok	<input type="checkbox"/> RemoteControlPro	<input type="checkbox"/> CrossLoop	<input type="checkbox"/> WindowsRDP
<input type="checkbox"/> pcAnywhere	<input type="checkbox"/> Timbuktu	<input type="checkbox"/> WindowsLiveSync	<input type="checkbox"/> SharedView	

Web HD				
<input type="checkbox"/> HTTP Upload	<input type="checkbox"/> HiNet SafeBox	<input type="checkbox"/> MS SkyDrive	<input type="checkbox"/> GDoc Uploader	<input type="checkbox"/> ADrive
<input type="checkbox"/> MyOtherDrive	<input type="checkbox"/> Mozy	<input type="checkbox"/> BoxNet	<input type="checkbox"/> OfficeLive	

OK Cancel

5.6.2 URL Content Filter Profile

To provide an appropriate cyberspace to users, Vigor router equips with **URL Content Filter** not only to limit illegal traffic from/to the inappropriate web sites but also prohibit other web feature where malicious code may conceal.

Once a user type in or click on an URL with objectionable keywords, URL keyword blocking facility will decline the HTTP request to that web page thus can limit user's access to the website. You may imagine **URL Content Filter** as a well-trained convenience-store clerk who won't sell adult magazines to teenagers. At office, **URL Content Filter** can also provide a job-related only environment hence to increase the employee work efficiency. How can URL Content Filter work better than traditional firewall in the field of filtering? Because it checks the URL strings or some of HTTP data hiding in the payload of TCP packets while legacy firewall inspects packets based on the fields of TCP/IP headers only.

On the other hand, Vigor router can prevent user from accidentally downloading malicious codes from web pages. It's very common that malicious codes conceal in the executable objects, such as ActiveX, Java Applet, compressed files, and other executable files. Once downloading these types of files from websites, you may risk bringing threat to your system. For example, an ActiveX control object is usually used for providing interactive web feature. If malicious code hides inside, it may occupy user's system.

For example, if you add key words such as "sex", Vigor router will limit web access to web sites or web pages such as "www.sex.com", "www.backdoor.net/images/sex/p_386.html". Or you may simply specify the full or partial URL such as "www.sex.com" or "sex.com".

Also the Vigor router will discard any request that tries to retrieve the malicious code.

Click **CSM** and click **URL Content Filter Profile** to open the profile setting page.

[CSM >> URL Content Filter Profile](#)

URL Content Filter Profile Table: [Set to Factory Default](#)

Profile	Name	Profile	Name
1.		5.	
2.		6.	
3.		7.	
4.		8.	

Administration Message (Max 255 characters)

```
<body><center><br><p>The requested Web page has been blocked by URL Content Filter.<p>Please contact your system administrator for further information.</center></body>
```

OK

You can set eight profiles as URL content filter. Simply click the index number under Profile to open the following web page.

Profile Index: 1

Profile Name:

Priority: **Log:**

1.URL Access Control

Enable URL Access Control Prevent web access from IP address

Action: Group/Object Selections:

2.Web Feature

Enable Restrict Web Feature

Action: Cookie Proxy **File Extension Profile:**

Profile Name

Type the name for such profile.

Priority

It determines the action that this router will apply.

Both: Pass – The router will let all the packages that match with the conditions specified in URL Access Control and Web Feature below passing through. When you choose this setting, both configuration set in this page for URL Access Control and Web Feature will be inactive.

Both: Block –The router will block all the packages that match with the conditions specified in URL Access Control and Web Feature below. When you choose this setting, both configuration set in this page for URL Access Control and Web Feature will be inactive.

Either: URL Access Control First – When all the packages matching with the conditions specified in URL Access Control and Web Feature below, such function can determine the priority for the actions executed. For this one, the router will process the packages with the conditions set below for URL first, then Web feature second.

Either: Web Feature First –When all the packages matching with the conditions specified in URL Access Control and Web Feature below, such function can determine the priority for the actions executed. For this one, the router will process the packages with the conditions set below for web feature first, then URL second.

Both : Pass

Both : Pass

Both : Block

Either : URL Access Control First

Either : Web Feature First

Log

None – There is no log file will be recorded for this profile.

Pass – Only the log about Pass will be recorded in Syslog.

Block – Only the log about Block will be recorded in Syslog.

All – All the actions (Pass and Block) will be recorded in Syslog.

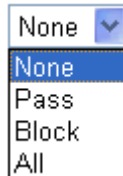

URL Access Control

Enable URL Access Control - Check the box to activate URL Access Control. Note that the priority for **URL Access Control** is higher than **Restrict Web Feature**. If the web content match the setting set in URL Access Control, the router will execute the action specified in this field and ignore the action specified under Restrict Web Feature.

Prevent web access from IP address - Check the box to deny any web surfing activity using IP address, such as http://202.6.5.2. The reason for this is to prevent someone dodges the URL Access Control. You must clear your browser cache first so that the URL content filtering facility operates properly on a web page that you visited before.

Action – This setting is available only when **Either : URL Access Control First** or **Either : Web Feature First** is selected. **Pass** - Allow accessing into the corresponding webpage with the keywords listed on the box below.

Block - Restrict accessing into the corresponding webpage with the keywords listed on the box below.

If the web pages do not match with the keyword set here, it will be processed with reverse action.

Action:



Group/Object Selections – The Vigor router provides several frames for users to define keywords and each frame supports multiple keywords. The keyword could be a noun, a partial noun, or a complete URL string. Multiple keywords within a frame are separated by space, comma, or semicolon. In addition, the maximal length of each frame is 32-character long. After specifying keywords, the Vigor router will decline the connection request to the website whose URL string matched to any user-defined keyword. It should be noticed that the more simplified the blocking keyword list, the more efficiently the Vigor router perform.

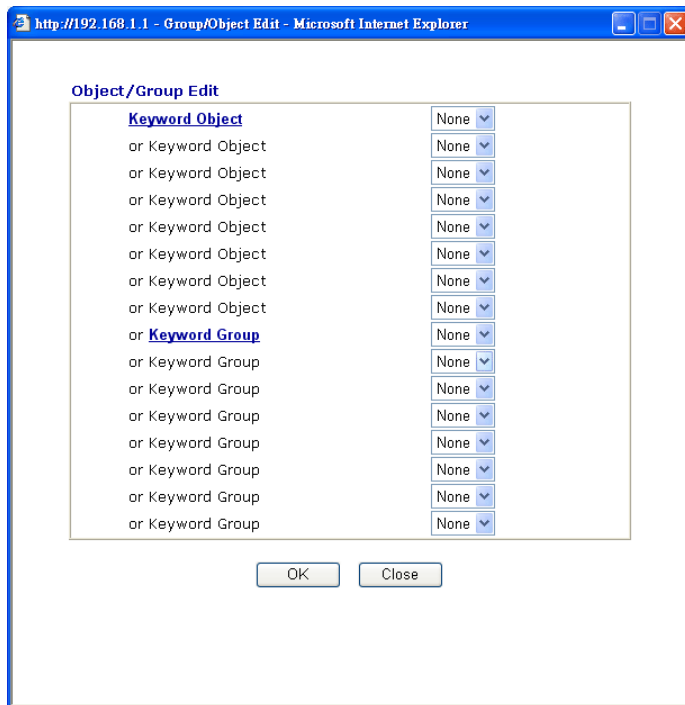

Web Feature

Enable Restrict Web Feature - Check this box to make the keyword being blocked or passed.

Action - This setting is available only when **Either : URL Access Control First** or **Either : Web Feature First** is selected. **Pass** allows accessing into the corresponding webpage with the keywords listed on the box below.

Pass - Allow accessing into the corresponding webpage with the keywords listed on the box below.

Block - Restrict accessing into the corresponding webpage with the keywords listed on the box below.

If the web pages do not match with the specified feature set here, it will be processed with reverse action.

Cookie - Check the box to filter out the cookie transmission from inside to outside world to protect the local user's privacy.

Proxy - Check the box to reject any proxy transmission. To control efficiently the limited-bandwidth usage, it will be of great value to provide the blocking mechanism that filters out the multimedia files downloading from web pages.

File Extension Profile – Choose one of the profiles that you configured in **Object Setting**>> **File Extension Objects** previously for passing or blocking the file downloading.

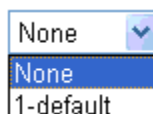

5.6.3 Web Content Filter Profile

There are three ways to activate WCF on vigor router, using **Service Activation Wizard**, by means of **CSM>>Web Content Filter Profile** or via **System Maintenance>>Activation**.

Service Activation Wizard allows you to use trial version or update the license of WCF directly without accessing into the server (**MyVigor**) located on <http://myvigor.draytek.com>.

However, if you use the **Web Content Filter Profile** page to activate WCF feature, it is necessary for you to access into the server (**MyVigor**) located on <http://myvigor.draytek.com>. Therefore, you need to register an account on <http://myvigor.draytek.com> for using corresponding service. Please refer to section of creating MyVigor account for more information.

Note: If you have used **Service Activation Wizard** to activate WCF service, you can skip this section.

WCF adopts the mechanism developed and offered by certain service provider. No matter activating WCF feature or getting a new license for web content filter, you have to click **Activate** to satisfy your request. Be aware that service provider matching with VigorIPPBX 2820 currently offers a period of time for trial version for users to experiment. If you want to purchase a formal edition, simply contact with the channel partner or your dealer.

Click **CSM** and click **Web Content Filter Profile** to open the profile setting page. The default setting for Setup Query Server /Setup Test Server is **auto-selected**. You can choose another server for your necessity by clicking **Find more** to open <http://myvigor.draytek.com> for searching another qualified and suitable one. Next, click the link of **Test a site to verify whether it is categorized** to do the verification.

CSM >> Web Content Filter Profile

Web-Filter License
[Activate](#)

[Status: Not Activated]

Setup Query Server	<input type="text" value="auto-selected"/>	Find more
Setup Test Server	<input type="text" value="auto-selected"/>	Find more

Web Content Filter Profile Table: [Set to Factory Default](#)

Profile	Name	Profile	Name
1.	Default	5.	
2.		6.	
3.		7.	
4.		8.	

Administration Message (Max 255 characters) Cache :

```
<body><center><br><br><br><p>The requested Web page <br> from %SIP% <br>to %URL%
<br>that is categorized with %CL% <br>has been blocked by %RNAME% Web Content
Filter.<p>Please contact your system administrator for further
information.</center></body>
```

Activate

Click it to access into MyVigor for activating WCF service.

Setup Query Server

It is recommended for you to use the default setting, auto-selected. You need to specify a server for categorize searching when you type URL in browser based on the web content filter profile.

Setup Test Server	It is recommend for you to use the default setting, auto-selected. By the way, you can click the link of Test a site to verify whether it is categorized to access into the test server selected.
Find more	Click it to open http://myvigor.draytek.com for searching another qualified and suitable server.
Test a site to verify whether it is categorized	Click this link to do the verification.
Set to Factory Default	Click this link to retrieve the factory settings.
Cache	<p>None – the router will check the URL that the user wants to access via WCF precisely, however, the processing rate is normal. Such item can provide the most accurate URL matching.</p> <p>L1 – the router will check the URL that the user wants to access via WCF. If the URL has been accessed previously, it will be stored for a short time (about 1 second) in the router to be accessed quickly if required. Such item can provide accurate URL matching with faster rate.</p> <p>L2 – the router will check the URL that the user wants to access via WCF. If the data has been accessed previously, the IP addresses of source and destination IDs will be memorized for a short time (about 1 second) in the router. When the user tries to access the same destination ID, the router will check it by comparing the record stored. If it matches, the page will be retrieved quickly. Such item can provide URL matching with the fastest rate.</p> <p>L1+L2 Cache – the router will check the URL with fast processing rate combining the feature of L1 and L2.</p>

Eight profiles are provided here as Web content filters. Simply click the index number under Profile to open the following web page. The items listed in Categories will be changed according to the different service providers. If you have and activate another web content filter license, the items will be changed simultaneously. All of the configuration made for web content filter will be deleted automatically. Therefore, please backup your data before you change the web content filter license.

CSM >> Web Content Filter Profile

Profile Index: 1

Profile Name:

Log:

Black/White List

Enable

Action:

Action:

Groups	Categories
<p>Child Protection</p> <p><input type="button" value="Select All"/></p> <p><input type="button" value="Clear All"/></p>	<p><input checked="" type="checkbox"/> Alcohol & Tobacco</p> <p><input checked="" type="checkbox"/> Hate & Intolerance</p> <p><input checked="" type="checkbox"/> Porn & Sexually</p> <p><input checked="" type="checkbox"/> School Cheating</p> <p><input checked="" type="checkbox"/> Child Abuse Images</p> <p><input checked="" type="checkbox"/> Criminal Activity</p> <p><input checked="" type="checkbox"/> Illegal Drug</p> <p><input checked="" type="checkbox"/> Violence</p> <p><input checked="" type="checkbox"/> Sex Education</p> <p><input checked="" type="checkbox"/> Gambling</p> <p><input checked="" type="checkbox"/> Nudity</p> <p><input checked="" type="checkbox"/> Weapons</p> <p><input checked="" type="checkbox"/> Tasteless</p>
<p>Leisure</p> <p><input type="button" value="Select All"/></p> <p><input type="button" value="Clear All"/></p>	<p><input type="checkbox"/> Entertainment</p> <p><input type="checkbox"/> Travel</p> <p><input type="checkbox"/> Games</p> <p><input type="checkbox"/> Leisure & Recreation</p> <p><input type="checkbox"/> Sports</p> <p><input type="checkbox"/> Fashion & Beauty</p>
<p>Business</p> <p><input type="button" value="Select All"/></p> <p><input type="button" value="Clear All"/></p>	<p><input type="checkbox"/> Business</p> <p><input type="checkbox"/> Job Search</p> <p><input type="checkbox"/> Web-based Mail</p>
<p>Chatting</p> <p><input type="button" value="Select All"/></p> <p><input type="button" value="Clear All"/></p>	<p><input type="checkbox"/> Chat</p> <p><input type="checkbox"/> Instant Messaging</p>
<p>Computer-Internet</p> <p><input type="button" value="Select All"/></p> <p><input type="button" value="Clear All"/></p>	<p><input type="checkbox"/> Anonymizers</p> <p><input type="checkbox"/> Download Sites</p> <p><input type="checkbox"/> Search Engine, Portals</p> <p><input type="checkbox"/> Malware</p> <p><input type="checkbox"/> Illegal Software</p> <p><input type="checkbox"/> Forums & Newsgroups</p> <p><input type="checkbox"/> Streaming, Downloads</p> <p><input type="checkbox"/> Social Networking</p> <p><input type="checkbox"/> Botnets</p> <p><input type="checkbox"/> Information Security</p> <p><input type="checkbox"/> Computers</p> <p><input type="checkbox"/> Phishing & Fraud</p> <p><input type="checkbox"/> Spam Sites</p> <p><input type="checkbox"/> Hacking</p> <p><input type="checkbox"/> Peer-to-Peer</p>
<p>Other</p> <p><input type="button" value="Select All"/></p> <p><input type="button" value="Clear All"/></p>	<p><input type="checkbox"/> Adv & Pop-Ups</p> <p><input type="checkbox"/> Compromised</p> <p><input type="checkbox"/> Finance</p> <p><input type="checkbox"/> News</p> <p><input type="checkbox"/> Politics</p> <p><input type="checkbox"/> Restaurants & Dining</p> <p><input type="checkbox"/> General</p> <p><input type="checkbox"/> Image Sharing</p> <p><input type="checkbox"/> Private IP Addresses</p> <p><input type="checkbox"/> Arts</p> <p><input type="checkbox"/> Dating & Personals</p> <p><input type="checkbox"/> Government</p> <p><input type="checkbox"/> Non-profits & NGOs</p> <p><input type="checkbox"/> Real Estate</p> <p><input type="checkbox"/> Shopping</p> <p><input type="checkbox"/> Cults</p> <p><input type="checkbox"/> Network Errors</p> <p><input type="checkbox"/> Uncategorised Sites</p> <p><input type="checkbox"/> Transportation</p> <p><input type="checkbox"/> Education</p> <p><input type="checkbox"/> Health & Medicine</p> <p><input type="checkbox"/> Personal Sites</p> <p><input type="checkbox"/> Religion</p> <p><input type="checkbox"/> Translators</p> <p><input type="checkbox"/> Greeting cards</p> <p><input type="checkbox"/> Parked Domains</p>

Profile Name

Type a name for such profile.

Log

None – There is no log file will be recorded for this profile.

Pass – Only the log about Pass will be recorded in Syslog.

Block – Only the log about Block will be recorded in Syslog.

All – All the actions (Pass and Block) will be recorded in Syslog.

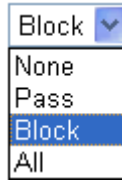

White/Black List

Enable – Activate white/black list function for such profile.

Group/Object Selections – Click **Edit** to choose the group or object profile as the content of white/black list.

Pass - **allow** accessing into the corresponding webpage with the characters listed on **Group/Object Selections**. If the web pages do not match with the specified feature set here, they will be processed with the categories listed on the box below.

Block - **block** accessing into the corresponding webpage with the characters listed on **Group/Object Selections**. If the web pages do not match with the specified feature set here, they will be processed with the categories listed on the box below.

Action

Pass - allow accessing into the corresponding webpage with the categories listed on the box below.

Block - restrict accessing into the corresponding webpage with the categories listed on the box below.

If the web pages do not match with the specified feature set here, it will be processed with reverse action.

5.7 Bandwidth Management

Below shows the menu items for Bandwidth Management.



5.7.1 Sessions Limit

A PC with private IP address can access to the Internet via NAT router. The router will generate the records of NAT sessions for such connection. The P2P (Peer to Peer) applications (e.g., BitTorrent) always need many sessions for procession and also they will occupy over resources which might result in important accesses impacted. To solve the problem, you can use limit session to limit the session procession for specified Hosts.

In the **Bandwidth Management** menu, click **Sessions Limit** to open the web page.

[Bandwidth Management >> Sessions Limit](#)

Sessions Limit

Enable **Disable**

Default Max Sessions:

Limitation List

Index	Start IP	End IP	Max Sessions
-------	----------	--------	--------------

Specific Limitation

Start IP: End IP:

Maximum Sessions:

Time Schedule

Index(1-15) in [Schedule](#) Setup: , , ,

Note: Action and Idle Timeout settings will be ignored.

To activate the function of limit session, simply click **Enable** and set the default session limit.

- Enable** Click this button to activate the function of limit session.
- Disable** Click this button to close the function of limit session.
- Default session limit** Defines the default session number used for each computer in LAN.
- Limitation List** Displays a list of specific limitations that you set on this web page.
- Start IP** Defines the start IP address for limit session.

End IP	Defines the end IP address for limit session.
Maximum Sessions	Defines the available session number for each host in the specific range of IP addresses. If you do not set the session number in this field, the system will use the default session limit for the specific limitation you set for each index.
Add	Adds the specific session limitation onto the list above.
Edit	Allows you to edit the settings for the selected limitation.
Remove	Remove the selected settings existing on the limitation list.
Index (1-15) in Schedule Setup	You can type in four sets of time schedule for your request. All the schedules can be set previously in Application >> Schedule web page and you can use the number that you have set in that web page.

5.7.2 Bandwidth Limit

The downstream or upstream from FTP, HTTP or some P2P applications will occupy large of bandwidth and affect the applications for other programs. Please use Limit Bandwidth to make the bandwidth usage more efficient.

In the **Bandwidth Management** menu, click **Bandwidth Limit** to open the web page.

[Bandwidth Management >> Bandwidth Limit](#)

Bandwidth Limit

Enable Apply to 2nd Subnet **Disable**

Default TX Limit: Kbps Default RX Limit: Kbps

Limitation List

Index	Start IP	End IP	TX limit	RX limit

Specific Limitation

Start IP: End IP:

TX Limit: Kbps RX Limit: Kbps

Time Schedule

Index(1-15) in [Schedule](#) Setup: , , ,

Note: Action and Idle Timeout settings will be ignored.

To activate the function of limit bandwidth, simply click **Enable** and set the default upstream and downstream limit.

Enable Click this button to activate the function of limit bandwidth. **Apply to 2nd Subnet** - if bandwidth limit function is enabled, please check this box to apply to

	second subnet.
Disable	Click this button to close the function of limit bandwidth.
Default TX limit	Define the default speed of the upstream for each computer in LAN.
Default RX limit	Define the default speed of the downstream for each computer in LAN.
Limitation List	Display a list of specific limitations that you set on this web page.
Start IP	Define the start IP address for limit bandwidth.
End IP	Define the end IP address for limit bandwidth.
TX limit	Define the limitation for the speed of the upstream. If you do not set the limit in this field, the system will use the default speed for the specific limitation you set for each index.
RX limit	Define the limitation for the speed of the downstream. If you do not set the limit in this field, the system will use the default speed for the specific limitation you set for each index.
Add	Add the specific speed limitation onto the list above.
Edit	Allows you to edit the settings for the selected limitation.
Delete	Remove the selected settings existing on the limitation list.
Index (1-15) in Schedule Setup	You can type in four sets of time schedule for your request. All the schedules can be set previously in Application>> Schedule web page and you can use the number that you have set in that web page.

5.7.3 Quality of Service

Deploying QoS (Quality of Service) management to guarantee that all applications receive the service levels required and sufficient bandwidth to meet performance expectations is indeed one important aspect of modern enterprise network.

One reason for QoS is that numerous TCP-based applications tend to continually increase their transmission rate and consume all available bandwidth, which is called TCP slow start. If other applications are not protected by QoS, it will detract much from their performance in the overcrowded network. This is especially essential to those are low tolerant of loss, delay or jitter (delay variation).

Another reason is due to congestions at network intersections where speeds of interconnected circuits mismatch or traffic aggregates, packets will queue up and traffic can be throttled back to a lower speed. If there's no defined priority to specify which packets should be discarded (or in another term "dropped") from an overflowing queue, packets of sensitive applications mentioned above might be the ones to drop off. How this will affect application performance?

There are two components within Primary configuration of QoS deployment:

- **Classification:** Identifying low-latency or crucial applications and marking them for high-priority service level enforcement throughout the network.

- **Scheduling:** Based on classification of service level to assign packets to queues and associated service types

The basic QoS implementation in Vigor routers is to classify and schedule packets based on the service type information in the IP header. For instance, to ensure the connection with the headquarter, a teleworker may enforce an index of QoS Control to reserve bandwidth for HTTPS connection while using lots of application at the same time.

One more larger-scale implementation of QoS network is to apply DSCP (Differentiated Service Code Point) and IP Precedence disciplines at Layer 3. Compared with legacy IP Precedence that uses Type of Service (ToS) field in the IP header to define 8 service classes, DSCP is a successor creating 64 classes possible with backward IP Precedence compatibility. In a QoS-enabled network, or Differentiated Service (DiffServ or DS) framework, a DS domain owner should sign a Service License Agreement (SLA) with other DS domain owners to define the service level provided toward traffic from different domains. Then each DS node in these domains will perform the priority treatment. This is called per-hop-behavior (PHB). The definition of PHB includes Expedited Forwarding (EF), Assured Forwarding (AF), and Best Effort (BE). AF defines the four classes of delivery (or forwarding) classes and three levels of drop precedence in each class.

Vigor routers as edge routers of DS domain shall check the marked DSCP value in the IP header of bypassing traffic, thus to allocate certain amount of resource execute appropriate policing, classification or scheduling. The core routers in the backbone will do the same checking before executing treatments in order to ensure service-level consistency throughout the whole QoS-enabled network.

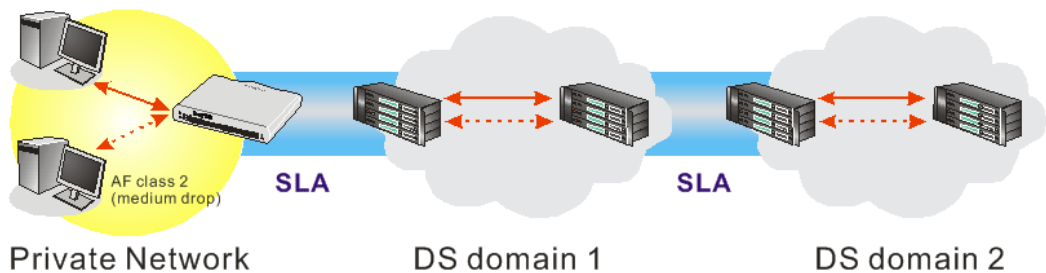

However, each node may take different attitude toward packets with high priority marking since it may bind with the business deal of SLA among different DS domain owners. It's not easy to achieve deterministic and consistent high-priority QoS traffic throughout the whole network with merely Vigor router's effort.

In the **Bandwidth Management** menu, click **Quality of Service** to open the web page.

[Bandwidth Management >> Quality of Service](#)

General Setup | [Set to Factory Default](#) |

Index	Status	Bandwidth	Direction	Class 1	Class 2	Class 3	Others	UDP Bandwidth Control	
WAN1	Enable	--Kbps/--Kbps	Outbound	25%	25%	25%	25%	Inactive	Setup
Backup WAN	Enable	10000Kbps/10000Kbps	Outbound	25%	25%	25%	25%	Inactive	Setup

Class Rule

Index	Name	Rule	Service Type
Class 1		Edit	Edit
Class 2		Edit	
Class 3		Edit	

This page displays the QoS settings result of the WAN interface. Click the **Setup** link to access into next page for the general setup of WAN interface. As to class rule, simply click the **Edit** link to access into next for configuration.

You can configure general setup for the WAN interface, edit the Class Rule, and edit the Service Type for the Class Rule for your request.

General Setup for WAN Interface

When you click **Setup**, you can configure the bandwidth ratio for QoS of the WAN interface. There are four queues allowed for QoS control. The first three (Class 1 to Class 3) class rules can be adjusted for your necessity. Yet, the last one is reserved for the packets which are not suitable for the user-defined class rules.

[Bandwidth Management >> Quality of Service](#)

WAN1 General Setup

Enable the QoS Control OUT

Index	Class Name	Reserved_bandwidth Ratio
Class 1		<input type="text" value="25"/> %
Class 2		<input type="text" value="25"/> %
Class 3		<input type="text" value="25"/> %
	Others	<input type="text" value="25"/> %

Enable UDP Bandwidth Control Limited_bandwidth Ratio %

Outbound TCP ACK Prioritize [Online Statistics](#)

WAN 1

Backup WAN General Setup

Enable the QoS Control OUT

WAN Inbound Bandwidth 10000 Kbps

WAN Outbound Bandwidth 10000 Kbps

Index	Class Name	Reserved_bandwidth Ratio
Class 1		25 %
Class 2		25 %
Class 3		25 %
	Others	25 %

Enable UDP Bandwidth Control Limited_bandwidth Ratio 25 %

Outbound TCP ACK Prioritize [Online Statistics](#)

Backup WAN

Enable the QoS Control The factory default for this setting is checked. Please also define which traffic the QoS Control settings will apply to.

IN- apply to incoming traffic only.

OUT- apply to outgoing traffic only.

BOTH- apply to both incoming and outgoing traffic.

Check this box and click **OK**, then click **Setup** link again. You will see the **Online Statistics** link appearing on this page.

WAN Inbound Bandwidth It allows you to set the connecting rate of data input for WAN. For example, if your ADSL supports 1M of downstream and 256K upstream, please set 1000kbps for this box. The default value is 1000kbps.

WAN Outbound Bandwidth It allows you to set the connecting rate of data output for WAN. For example, if your ADSL supports 1M of downstream and 256K upstream, please set 256kbps for this box. The default value is 1000kbps.

Reserved Bandwidth Ratio It is reserved for the group index in the form of ratio of **reserved bandwidth to upstream speed** and **reserved bandwidth to downstream speed**.

Enable UDP Bandwidth Control Check this and set the limited bandwidth ratio on the right field. This is a protection of TCP application traffic since UDP application traffic such as streaming video will exhaust lots of bandwidth.

Outbound TCP ACK Prioritize The difference in bandwidth between download and upload are great in ADSL2+ environment. For the download speed might be impacted by the uploading TCP ACK, you can check this box to push ACK of upload faster to speed the network traffic.

Limited_bandwidth Ratio The ratio typed here is reserved for limited bandwidth of UDP application.

Online Statistics

Display an online statistics for quality of service for your reference. This link will be seen only if you click **OK** in WAN1/Backup WAN General Setup web page and click Setup again (for WAN1/ Backup WAN) on the **Bandwidth Management>>Quality of Service**.

[Bandwidth Management>> Quality of Service](#)

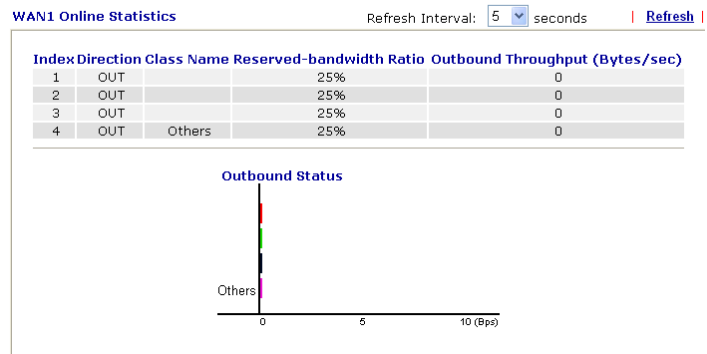

Edit the Class Rule for QoS

The first three (Class 1 to Class 3) class rules can be adjusted for your necessity. To add, edit or delete the class rule, please click the **Edit** link of that one.

[Bandwidth Management >> Quality of Service](#)

General Setup | [Set to Factory Default](#) |

Index	Status	Bandwidth	Direction	Class 1	Class 2	Class 3	Others	UDP Bandwidth Control	
WAN1	Enable	--Kbps/--Kbps	Outbound	25%	25%	25%	25%	Inactive	Setup
Backup WAN	Enable	10000Kbps/10000Kbps	Outbound	25%	25%	25%	25%	Inactive	Setup

Class Rule

Index	Name	Rule	Service Type
Class 1		Edit	Edit
Class 2		Edit	
Class 3		Edit	

After you click the **Edit** link, you will see the following page. Now you can define the name for that Class. In this case, “Test” is used as the name of Class Index #1.

[Bandwidth Management >> Quality of Service](#)

Class Index #1

Name

NO	Status	Local Address	Remote Address	DiffServ CodePoint	Service Type
1	Empty	-	-	-	-

For adding a new rule, click **Add** to open the following page.

[Bandwidth Management >> Quality of Service](#)

Rule Edit

<input checked="" type="checkbox"/> ACT	
Local Address	<input type="text" value="Any"/> <input type="button" value="Edit"/>
Remote Address	<input type="text" value="Any"/> <input type="button" value="Edit"/>
DiffServ CodePoint	<input type="text" value="ANY"/>
Service Type	<input type="text" value="ANY"/>

Note: Please choose/setup the [Service Type](#) first.

ACT

Check this box to invoke these settings.

Local Address

Click the **Edit** button to set the local IP address (on LAN) for the rule.

Remote Address

Click the **Edit** button to set the remote IP address (on LAN/WAN) for the rule.

Edit

It allows you to edit source address information.

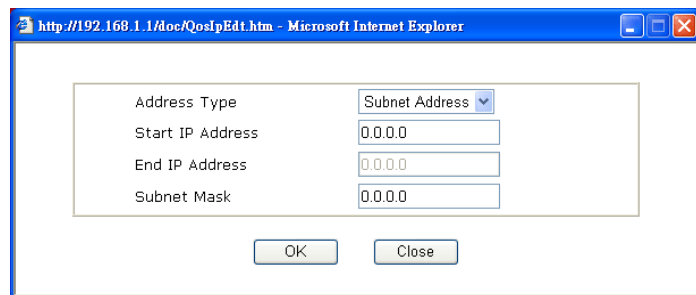

Address Type – Determine the address type for the source address.

For **Single Address**, you have to fill in Start IP address.

For **Range Address**, you have to fill in Start IP address and End IP address.

For **Subnet Address**, you have to fill in Start IP address and Subnet Mask.

DiffServ CodePoint

All the packets of data will be divided with different levels and will be processed according to the level type by the system. Please assign one of the levels of the data for processing with QoS control.

Service Type

It determines the service type of the data for processing with QoS control. It can also be edited. You can choose the predefined service type from the Service Type drop down list. Those types are predefined in factory. Simply choose the one that you want for using by current QoS.

By the way, you can set up to 20 rules for one Class. If you want to edit an existed rule, please select the radio button of that one and click **Edit** to open the rule edit page for modification.

[Bandwidth Management >> Quality of Service](#)

Class Index # 1

Name

NO	Status	Local Address	Remote Address	DiffServ CodePoint	Service Type
1 <input type="radio"/>	Active		Any	ANY	ANY
2 <input type="radio"/>	Active	~	Any	AF Class4 (High Drop)	TELNET(TCP:23)

Edit the Service Type for Class Rule

To add a new service type, edit or delete an existed service type, please click the Edit link under Service Type field.

[Bandwidth Management >> Quality of Service](#)

General Setup

[Set to Factory Default](#)

Index	Status	Bandwidth	Direction	Class 1	Class 2	Class 3	Others	UDP Bandwidth Control	
WAN1	Enable	--Kbps/--Kbps	Outbound	25%	25%	25%	25%	Inactive	Setup
Backup WAN	Enable	10000Kbps/10000Kbps	Outbound	25%	25%	25%	25%	Inactive	Setup

Class Rule

Index	Name	Rule	Service Type
Class 1		Edit	
Class 2		Edit	Edit
Class 3		Edit	

After you click the **Edit** link, you will see the following page.

[Bandwidth Management >> Quality of Service](#)

User Defined Service Type

NO	Name	Protocol	Port
1	Empty	-	-

For adding a new service type, click **Add** to open the following page.

[Bandwidth Management >> Quality of Service](#)

Service Type Edit

Service Name	<input type="text"/>
Service Type	TCP <input type="text" value="6"/>
Port Configuration	
Type	<input checked="" type="radio"/> Single <input type="radio"/> Range
Port Number	<input type="text" value="0"/> - <input type="text" value="0"/>

Service Name

Type in a new service for your request.

Service Type

Choose the type (TCP, UDP or TCP/UDP) for the new service.

Port Configuration

Click **Single** or **Range** as the **Type**. If you select Range, you have to type in the starting port number and the end porting number on the boxes below.

Port Number – Type in the starting port number and the end porting number here if you choose Range as the type.

By the way, you can set up to 40 service types. If you want to edit/delete an existed service type, please select the radio button of that one and click **Edit/Edit** for modification.

5.8 Applications

Below shows the menu items for Applications.

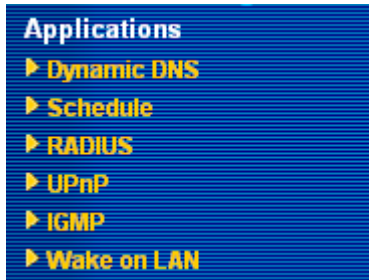

5.8.1 Dynamic DNS

The ISP often provides you with a dynamic IP address when you connect to the Internet via your ISP. It means that the public IP address assigned to your router changes each time you access the Internet. The Dynamic DNS feature lets you assign a domain name to a dynamic WAN IP address. It allows the router to update its online WAN IP address mappings on the specified Dynamic DNS server. Once the router is online, you will be able to use the registered domain name to access the router or internal virtual servers from the Internet. It is particularly helpful if you host a web server, FTP server, or other server behind the router.

Before you use the Dynamic DNS feature, you have to apply for free DDNS service to the DDNS service providers. The router provides up to three accounts from three different DDNS service providers. Basically, Vigor routers are compatible with the DDNS services supplied by most popular DDNS service providers such as www.dyndns.org, www.no-ip.com, www.dtdns.com, www.changeip.com, www.dynamic-nameserver.com. You should visit their websites to register your own domain name for the router.

Enable the Function and Add a Dynamic DNS Account

1. Assume you have a registered domain name from the DDNS provider, say *hostname.dyndns.org*, and an account with username: *test* and password: *test*.
2. In the DDNS setup menu, check **Enable Dynamic DNS Setup**.

[Applications >> Dynamic DNS Setup](#)

Dynamic DNS Setup | [Set to Factory Default](#)

Enable Dynamic DNS Setup [View Log](#) [Force Update](#)

Auto-Update interval Min(s) (1~14400)

Accounts:

Index	WAN Interface	Domain Name	Active
1.	WAN1 First	.	x
2.	WAN1 First	.	x
3.	WAN1 First	.	x

[OK](#) [Clear All](#)

Set to Factory Default

Clear all profiles and recover to factory settings.

Enable Dynamic DNS Setup

Check this box to enable DDNS function.

Index

Click the number below Index to access into the setting page

of DDNS setup to set account(s).

WAN Interface	Display current WAN interface used for accessing Internet.
Domain Name	Display the domain name that you set on the setting page of DDNS setup.
Active	Display if this account is active or inactive.
View Log	Display DDNS log status.
Force Update	Force the router updates its information to DDNS server.

3. Select Index number 1 to add an account for the router. Check **Enable Dynamic DNS Account**, and choose correct Service Provider: dyndns.org, type the registered hostname: *hostname* and domain name suffix: dyndns.org in the **Domain Name** block.

[Applications >> Dynamic DNS Setup >> Dynamic DNS Account Setup](#)

Index : 1

Enable Dynamic DNS Account

WAN Interface	WAN1 First	
Service Provider	dyndns.org (www.dyndns.org)	
Service Type	Dynamic	
Domain Name	chronic6633	dyndns.org
Login Name	chronic6633	(max. 64 characters)
Password	●●●●●●●●	(max. 23 characters)
<input type="checkbox"/> Wildcards		
<input type="checkbox"/> Backup MX		
Mail Extender		

OK Clear Cancel

Enable Dynamic DNS Account Check this box to enable the current account. If you did check the box, you will see a check mark appeared on the Active column of the previous web page in step 2).

WAN Interface Select the WAN interface order to apply settings here.

Service Provider Select the service provider for the DDNS account.

Service Type Select a service type (Dynamic, Custom or Static). If you choose Custom, you can modify the domain that is chosen in the Domain Name field.

Domain Name Type in one domain name that you applied previously. Use the drop down list to choose the desired domain.

Login Name Type in the login name that you set for applying domain.

Password Type in the password that you set for applying domain.

4. Click **OK** button to activate the settings. You will see your setting has been saved.

The Wildcard and Backup MX features are not supported for all Dynamic DNS providers. You could get more detailed information from their websites.

5.8.2 Schedule

The Vigor router has a built-in real time clock which can update itself manually or automatically by means of Network Time Protocols (NTP). As a result, you can not only schedule the router to dialup to the Internet at a specified time, but also restrict Internet access to certain hours so that users can connect to the Internet only during certain hours, say, business hours. The schedule is also applicable to other functions.

You have to set your time before set schedule. In **System Maintenance>> Time and Date** menu, press **Inquire Time** button to set the Vigor router's clock to current time of your PC. The clock will reset once if you power down or reset the router. There is another way to set up time. You can inquiry an NTP server (a time server) on the Internet to synchronize the router's clock. This method can only be applied when the WAN connection has been built up.

Applications >> Schedule

Schedule: [Set to Factory Default](#)

Index	Status	Index	Status
1.	x	9.	x
2.	x	10.	x
3.	x	11.	x
4.	x	12.	x
5.	x	13.	x
6.	x	14.	x
7.	x	15.	x
8.	x		

Status: v --- Active, x --- Inactive

Set to Factory Default

Clear all profiles and recover to factory settings.

Index

Click the number below Index to access into the setting page of schedule.

Status

Display if this schedule setting is active or inactive.

You can set up to 15 schedules. Then you can apply them to your **Internet Access** or **VPN and Remote Access >> LAN to LAN** settings.

To add a schedule, please click any index, say Index No. 1. The detailed settings of the call schedule with index 1 are shown below.

Applications >> Schedule

Index No. 1

Enable Schedule Setup

Start Date (yyyy-mm-dd) 2000 - 1 - 1

Start Time (hh:mm) 0 : 0

Duration Time (hh:mm) 0 : 0

Action Force On

Idle Timeout 0 minute(s).(max. 255, 0 for default)

How Often

Once

Weekdays

Sun Mon Tue Wed Thu Fri Sat

OK Clear Cancel

Enable Schedule Setup	Check to enable the schedule.
Start Date (yyyy-mm-dd)	Specify the starting date of the schedule.
Start Time (hh:mm)	Specify the starting time of the schedule.
Duration Time (hh:mm)	Specify the duration (or period) for the schedule.
Action	Specify which action Call Schedule should apply during the period of the schedule.
	Force On -Force the connection to be always on.
	Force Down -Force the connection to be always down.
	Enable Dial-On-Demand -Specify the connection to be dial-on-demand and the value of idle timeout should be specified in Idle Timeout field.
	Disable Dial-On-Demand -Specify the connection to be up when it has traffic on the line. Once there is no traffic over idle timeout, the connection will be down and never up again during the schedule.
Idle Timeout	Specify the duration (or period) for the schedule.
	How often -Specify how often the schedule will be applied
	Once -The schedule will be applied just once
	Weekdays -Specify which days in one week should perform the schedule.

Example

Suppose you want to control the PPPoE Internet access connection to be always on (Force On) from 9:00 to 18:00 for whole week. Other time the Internet access connection should be disconnected (Force Down).

Office
Hour:
(Force On)



Mon - Sun 9:00 am to 6:00 pm

1. Make sure the PPPoE connection and **Time Setup** is working properly.
2. Configure the PPPoE always on from 9:00 to 18:00 for whole week.
3. Configure the **Force Down** from 18:00 to next day 9:00 for whole week.
4. Assign these two profiles to the PPPoE Internet access profile. Now, the PPPoE Internet connection will follow the schedule order to perform **Force On** or **Force Down** action according to the time plan that has been pre-defined in the schedule profiles.

5.8.3 RADIUS

Remote Authentication Dial-In User Service (RADIUS) is a security authentication client/server protocol that supports authentication, authorization and accounting, which is widely used by Internet service providers. It is the most common method of authenticating and authorizing dial-up and tunneled network users.

The built-in RADIUS client feature enables the router to assist the remote dial-in user or a wireless station and the RADIUS server in performing mutual authentication. It enables centralized remote access authentication for network management.

[Applications >> RADIUS](#)

RADIUS Setup

<input checked="" type="checkbox"/> Enable	
Server IP Address	<input type="text"/>
Destination Port	<input type="text" value="1812"/>
Shared Secret	<input type="text"/>
Confirm Shared Secret	<input type="text"/>

Enable	Check to enable RADIUS client feature
Server IP Address	Enter the IP address of RADIUS server
Destination Port	The UDP port number that the RADIUS server is using. The default value is 1812, based on RFC 2138.
Shared Secret	The RADIUS server and client share a secret that is used to authenticate the messages sent between them. Both sides must be configured to use the same shared secret.
Confirm Shared Secret	Re-type the Shared Secret for confirmation.

5.8.4 UPnP

The **UPnP** (Universal Plug and Play) protocol is supported to bring to network connected devices the ease of installation and configuration which is already available for directly connected PC peripherals with the existing Windows 'Plug and Play' system. For NAT routers, the major feature of UPnP on the router is "NAT Traversal". This enables applications inside the firewall to automatically open the ports that they need to pass through a router. It is more reliable than requiring a router to work out by itself which ports need to be opened. Further, the user does not have to manually set up port mappings or a DMZ. **UPnP is available on Windows XP** and the router provide the associated support for MSN Messenger to allow full use of the voice, video and messaging features.

Applications >> UPnP

UPnP

Enable UPnP Service

Enable Connection control Service

Enable Connection Status Service

Note: If you intend running UPnP service inside your LAN, you should check the appropriate service above to allow control, as well as the appropriate UPnP settings.

OK Clear Cancel

Enable UPnP Service

Accordingly, you can enable either the **Connection Control Service** or **Connection Status Service**.

After setting **Enable UPnP Service** setting, an icon of **IP Broadband Connection on Router** on Windows XP/Network Connections will appear. The connection status and control status will be able to be activated. The NAT Traversal of UPnP enables the multimedia features of your applications to operate. This has to manually set up port mappings or use other similar methods. The screenshots below show examples of this facility.

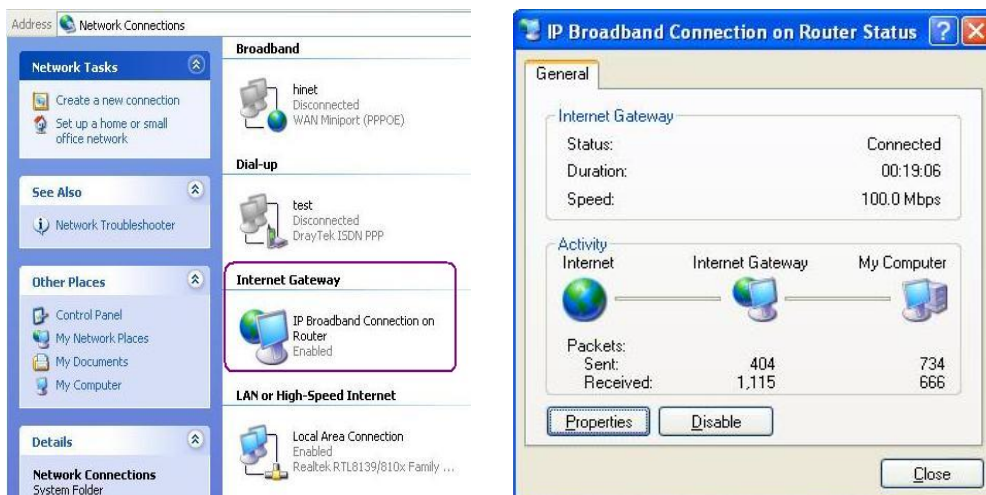

The UPnP facility on the router enables UPnP aware applications such as MSN Messenger to discover what are behind a NAT router. The application will also learn the external IP address and configure port mappings on the router. Subsequently, such a facility forwards packets from the external ports of the router to the internal ports used by the application.

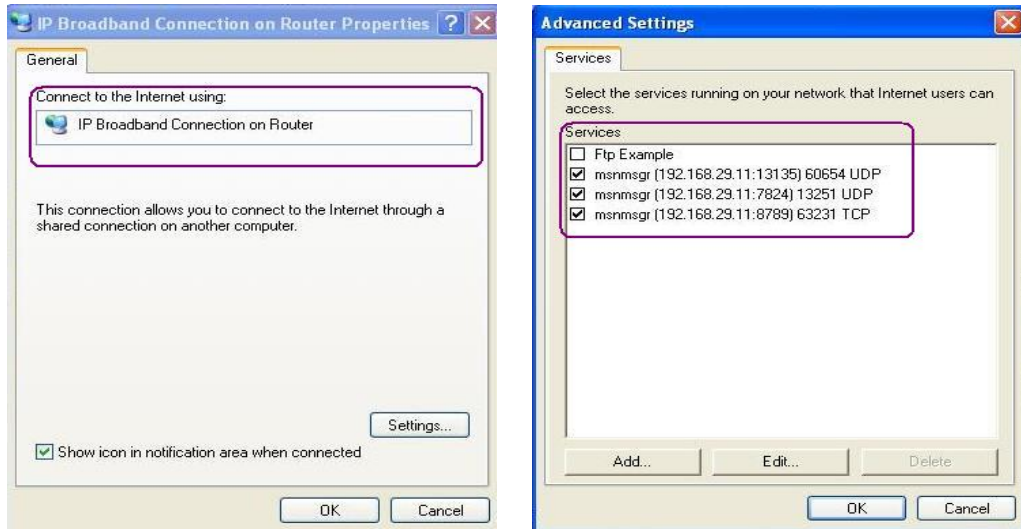

The reminder as regards concern about Firewall and UPnP

Can't work with Firewall Software

Enabling firewall applications on your PC may cause the UPnP function not working properly. This is because these applications will block the accessing ability of some network ports.

Security Considerations

Activating the UPnP function on your network may incur some security threats. You should consider carefully these risks before activating the UPnP function.

- Some Microsoft operating systems have found out the UPnP weaknesses and hence you need to ensure that you have applied the latest service packs and patches.
- Non-privileged users can control some router functions, including removing and adding port mappings.

The UPnP function dynamically adds port mappings on behalf of some UPnP-aware applications. When the applications terminate abnormally, these mappings may not be removed.

5.8.5 IGMP

IGMP is the abbreviation of *Internet Group Management Protocol*. It is a communication protocol which is mainly used for managing the membership of Internet Protocol multicast groups. For invoking IGMP Snooping function, you have to check the Enable IGMP Proxy box first for activating the IGMP proxy function.

Applications >> IGMP

IGMP

Enable IGMP Proxy WAN1 ▾
 IGMP Proxy is to act as a multicast proxy for hosts on the LAN side. Enable IGMP Proxy, if you will access any multicast group. But this function **take no affect when Bridge Mode is enabled**.

Enable IGMP Snooping
 Enable IGMP Snooping, multicast traffic is only forwarded to ports that have members of that group. Disable IGMP snooping, multicast traffic is treated in the same manner as broadcast traffic.

| [Refresh](#) |

Working Multicast Groups						
Index	Group ID	P1	P2	P3	P4	

Enable IGMP Proxy

Check this box to enable this function. The application of multicast will be executed through WAN port you specified.

WAN1 ▾
 WAN1
 WAN2

Enable IGMP Snooping

Check this box to enable this function. The application of multicast will be executed for the clients in LAN.

Group ID

This field displays the ID port for the multicast group. The available range for IGMP starts from 224.0.0.0 to 239.255.255.254.

P1 to P4

It indicates the LAN port used for the multicast group.

Refresh

Click this link to renew the working multicast group status.

If you check Enable IGMP Proxy, you will get the following page. All the multicast groups will be listed and all the LAN ports (P1 to P4) are available for use.

5.8.6 Wake on LAN

A PC client on LAN can be woken up by the router it connects. When a user wants to wake up a specified PC through the router, he/she must type correct MAC address of the specified PC on this web page of **Wake on LAN** of this router.

In addition, such PC must have installed a network card supporting WOL function. By the way, WOL function must be set as “Enable” on the BIOS setting.

[Application >> Wake on LAN](#)

Wake on LAN

Note: Wake on LAN integrates with [Bind IP to MAC](#) function, only binded PCs can wake up through IP.

Wake by:

IP Address:

MAC Address:

Result

Wake by

Two types provide for you to wake up the binded IP. If you choose Wake by MAC Address, you have to type the correct MAC address of the host in MAC Address boxes. If you choose Wake by IP Address, you have to choose the correct IP address.

Wake by:

IP Address

The IP addresses that have been configured in **Firewall>>Bind IP to MAC** will be shown in this drop down list. Choose the IP address from the drop down list that you want to wake up.

MAC Address

Type any one of the MAC address of the binded PCs.

Wake Up

Click this button to wake up the selected IP. See the following figure. The result will be shown on the box.

[Application >> Wake on LAN](#)

Wake on LAN

Note: Wake on LAN integrates with [Bind IP to MAC](#) function, only binded PCs can wake up through IP.

Wake by:

IP Address:

MAC Address:

Result

Send command to client done.

5.9 VPN and Remote Access

A Virtual Private Network (VPN) is the extension of a private network that encompasses links across shared or public networks like the Internet. In short, by VPN technology, you can send data between two computers across a shared or public network in a manner that emulates the properties of a point-to-point private link.

Below shows the menu items for VPN and Remote Access.

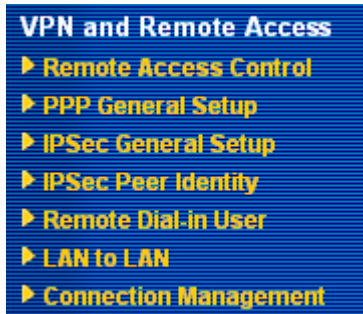

5.9.1 Remote Access Control

Enable the necessary VPN service as you need. If you intend to run a VPN server inside your LAN, you should disable the VPN service of Vigor Router to allow VPN tunnel pass through, as well as the appropriate NAT settings, such as DMZ or open port.

VPN and Remote Access >> Remote Access Control Setup

Remote Access Control Setup

<input checked="" type="checkbox"/>	Enable PPTP VPN Service
<input checked="" type="checkbox"/>	Enable IPSec VPN Service
<input checked="" type="checkbox"/>	Enable L2TP VPN Service
<input type="checkbox"/>	Enable ISDN Dial-In

Note: If you intend running a VPN server inside your LAN, you should uncheck the appropriate protocol above to allow pass-through, as well as the appropriate NAT settings.

The Vigor router will not accept the ISDN dial-in connection if the box of **Enable ISDN Dial-in** is not checked.

5.9.2 PPP General Setup

This submenu only applies to PPP-related VPN connections, such as PPTP, L2TP, L2TP over IPSec.

[VPN and Remote Access >> PPP General Setup](#)

PPP General Setup

PPP/MP Protocol		IP Address Assignment for Dial-In Users (When DHCP Disable set)	
Dial-In PPP Authentication	PAP or CHAP ▾	Start IP Address	192.168.1.200
Dial-In PPP Encryption (MPPE)	Optional MPPE ▾		
Mutual Authentication (PAP)	<input type="radio"/> Yes <input checked="" type="radio"/> No		
Username	<input type="text"/>		
Password	<input type="text"/>		

Dial-In PPP Authentication **PAP Only** - Select this option to force the router to authenticate dial-in users with the PAP protocol.

PAP or CHAP - Selecting this option means the router will attempt to authenticate dial-in users with the CHAP protocol first. If the dial-in user does not support this protocol, it will fall back to use the PAP protocol for authentication.

Dial-In PPP Encryption (MPPE)

Optional MPPE - This option represents that the MPPE encryption method will be optionally employed in the router for the remote dial-in user. If the remote dial-in user does not support the MPPE encryption algorithm, the router will transmit “no MPPE encrypted packets”. Otherwise, the MPPE encryption scheme will be used to encrypt the data.

Optional MPPE ▾

- Optional MPPE
- Require MPPE(40/128 bit)
- Maximum MPPE(128 bit)

Require MPPE (40/128bits) - Selecting this option will force the router to encrypt packets by using the MPPE encryption algorithm. In addition, the remote dial-in user will use 40-bit to perform encryption prior to using 128-bit for encryption. In other words, if 128-bit MPPE encryption method is not available, then 40-bit encryption scheme will be applied to encrypt the data.

Maximum MPPE - This option indicates that the router will use the MPPE encryption scheme with maximum bits (128-bit) to encrypt the data.

Mutual Authentication (PAP)

The Mutual Authentication function is mainly used to communicate with other routers or clients who need bi-directional authentication in order to provide stronger security, for example, Cisco routers. So you should enable this function when your peer router requires mutual authentication. You should further specify the **User Name**

and **Password** of the mutual authentication peer.

Start IP Address

Enter a start IP address for the dial-in PPP connection. You should choose an IP address from the local private network. For example, if the local private network is 192.168.1.0/255.255.255.0, you could choose 192.168.1.200 as the Start IP Address. But, you have to notice that the first two IP addresses of 192.168.1.200 and 192.168.1.201 are reserved for ISDN remote dial-in user.

5.9.3 IPSec General Setup

In **IPSec General Setup**, there are two major parts of configuration.

There are two phases of IPSec.

- Phase 1: negotiation of IKE parameters including encryption, hash, Diffie-Hellman parameter values, and lifetime to protect the following IKE exchange, authentication of both peers using either a Pre-Shared Key or Digital Signature (x.509). The peer that starts the negotiation proposes all its policies to the remote peer and then remote peer tries to find a highest-priority match with its policies. Eventually to set up a secure tunnel for IKE Phase 2.
- Phase 2: negotiation IPSec security methods including Authentication Header (AH) or Encapsulating Security Payload (ESP) for the following IKE exchange and mutual examination of the secure tunnel establishment.

There are two encapsulation methods used in IPSec, **Transport** and **Tunnel**. The **Transport** mode will add the AH/ESP payload and use original IP header to encapsulate the data payload only. It can just apply to local packet, e.g., L2TP over IPSec. The **Tunnel** mode will not only add the AH/ESP payload but also use a new IP header (Tunneled IP header) to encapsulate the whole original IP packet.

Authentication Header (AH) provides data authentication and integrity for IP packets passed between VPN peers. This is achieved by a keyed one-way hash function to the packet to create a message digest. This digest will be put in the AH and transmitted along with packets. On the receiving side, the peer will perform the same one-way hash on the packet and compare the value with the one in the AH it receives.

Encapsulating Security Payload (ESP) is a security protocol that provides data confidentiality and protection with optional authentication and replay detection service.

VPN and Remote Access >> IPSec General Setup

VPN IKE/IPSec General Setup

Dial-in Set up for Remote Dial-in users and Dynamic IP Client (LAN to LAN).

IKE Authentication Method

Pre-Shared Key

Confirm Pre-Shared Key

IPSec Security Method

Medium (AH)
Data will be authentic, but will not be encrypted.

High (ESP) DES 3DES AES
Data will be encrypted and authentic.

OK Cancel

IKE Authentication

This usually applies to those are remote dial-in user or node

Method (LAN-to-LAN) which uses dynamic IP address and IPSec-related VPN connections such as L2TP over IPSec and IPSec tunnel.

Pre-Shared Key -Currently only support Pre-Shared Key for IKE authentication

Confirm Pre-Shared Key- Retype the characters to confirm the pre-shared key.

IPSec Security Method **Medium** - Authentication Header (AH) means data will be authenticated, but not be encrypted. By default, this option is active.

High - Encapsulating Security Payload (ESP) means payload (data) will be encrypted and authenticated. You may select encryption algorithm from Data Encryption Standard (DES), Triple DES (3DES), and AES.

5.9.4 IPSec Peer Identity

To use digital certificate for peer authentication in either LAN-to-LAN connection or Remote User Dial-In connection, here you may edit a table of peer certificate for selection. As shown below, the router provides **32** entries of digital certificates for peer dial-in users.

[VPN and Remote Access >> IPSec Peer Identity](#)

X509 Peer ID Accounts: [Set to Factory Default](#)

Index	Name	Status	Index	Name	Status
1.	???	×	17.	???	×
2.	???	×	18.	???	×
3.	???	×	19.	???	×
4.	???	×	20.	???	×
5.	???	×	21.	???	×
6.	???	×	22.	???	×
7.	???	×	23.	???	×
8.	???	×	24.	???	×
9.	???	×	25.	???	×
10.	???	×	26.	???	×
11.	???	×	27.	???	×
12.	???	×	28.	???	×
13.	???	×	29.	???	×
14.	???	×	30.	???	×
15.	???	×	31.	???	×
16.	???	×	32.	???	×

Set to Factory Default Click it to clear all indexes.

Index Click the number below Index to access into the setting page of IPSec Peer Identity.

Name Display the profile name of that index.

Click each index to edit one peer digital certificate. There are three security levels of digital signature authentication: Fill each necessary field to authenticate the remote peer. The following explanation will guide you to fill all the necessary fields.

Profile Index : 1

Profile Name

Enable this account

Accept Any Peer ID

Accept Subject Alternative Name

Type

IP

Accept Subject Name

Country (C)

State (ST)

Location (L)

Organization (O)

Organization Unit (OU)

Common Name (CN)

Email (E)

- Profile Name** Type in a name in this file.
- Accept Any Peer ID** Click to accept any peer regardless of its identity.
- Accept Subject Alternative Name** Click to check one specific field of digital signature to accept the peer with matching value. The field can be **IP Address, Domain, or E-mail Address**. The box under the Type will appear according to the type you select and ask you to fill in corresponding setting.
- Accept Subject Name** Click to check the specific fields of digital signature to accept the peer with matching value. The field includes **Country (C), State (ST), Location (L), Organization (O), Organization Unit (OU), Common Name (CN), and Email (E)**.

5.9.5 Remote Dial-in User

You can manage remote access by maintaining a table of remote user profile, so that users can be authenticated to dial-in via ISDN or build the VPN connection. You may set parameters including specified connection peer ID, connection type (ISDN Dial-In connection, VPN connection - including PPTP, IPSec Tunnel, and L2TP by itself or over IPSec) and corresponding security methods, etc.

The router provides **32** access accounts for dial-in users. Besides, you can extend the user accounts to the RADIUS server through the built-in RADIUS client function. The following figure shows the summary table.

VPN and Remote Access >> Remote Dial-in User

Remote Access User Accounts: [Set to Factory Default](#)

Index	User	Status	Index	User	Status
1.	???	X	17.	???	X
2.	???	X	18.	???	X
3.	???	X	19.	???	X
4.	???	X	20.	???	X
5.	???	X	21.	???	X
6.	???	X	22.	???	X
7.	???	X	23.	???	X
8.	???	X	24.	???	X
9.	???	X	25.	???	X
10.	???	X	26.	???	X
11.	???	X	27.	???	X
12.	???	X	28.	???	X
13.	???	X	29.	???	X
14.	???	X	30.	???	X
15.	???	X	31.	???	X
16.	???	X	32.	???	X

Set to Factory Default

Click to clear all indexes.

Index

Click the number below Index to access into the setting page of Remote Dial-in User.

User

Display the username for the specific dial-in user of the LAN-to-LAN profile. The symbol ??? represents that the profile is empty.

Status

Display the access state of the specific dial-in user. The symbol V and X represent the specific dial-in user to be active and inactive, respectively.

Click each index to edit one remote user profile. **Each Dial-In Type requires you to fill the different corresponding fields on the right.** If the fields gray out, it means you may leave it untouched. The following explanation will guide you to fill all the necessary fields.

Index No. 1

<p>User account and Authentication</p> <p><input checked="" type="checkbox"/> Enable this account</p> <p>Idle Timeout <input type="text" value="300"/> second(s)</p>		<p>Username <input style="width: 100px;" type="text" value="???"/></p> <p>Password <input style="width: 100px;" type="password"/></p> <p><input type="checkbox"/> Enable Mobile One-Time Passwords(mOTP)</p> <p>PIN Code <input style="width: 100px;" type="text"/></p> <p>Secret <input style="width: 100px;" type="text"/></p>
<p>Allowed Dial-In Type</p> <p><input checked="" type="checkbox"/> ISDN</p> <p><input checked="" type="checkbox"/> PPTP</p> <p><input checked="" type="checkbox"/> IPsec Tunnel</p> <p><input checked="" type="checkbox"/> L2TP with IPsec Policy <input style="width: 50px;" type="text" value="None"/></p> <p><input type="checkbox"/> Specify Remote Node</p> <p>Remote Client IP or Peer ISDN Number <input style="width: 100px;" type="text"/></p> <p>or Peer ID <input style="width: 100px;" type="text"/></p> <p>Netbios Naming Packet <input checked="" type="radio"/> Pass <input type="radio"/> Block</p> <p>Multicast via VPN <input type="radio"/> Pass <input checked="" type="radio"/> Block</p> <p><small>(for some IGMP,IP-Camera,DHCP Relay..etc.)</small></p>		<p>IKE Authentication Method</p> <p><input checked="" type="checkbox"/> Pre-Shared Key</p> <p>IKE Pre-Shared Key <input style="width: 100px;" type="text"/></p> <p><input type="checkbox"/> Digital Signature(X.509)</p> <p><input style="width: 50px;" type="text" value="None"/></p>
		<p>IPsec Security Method</p> <p><input checked="" type="checkbox"/> Medium(AH)</p> <p>High(ESP) <input checked="" type="checkbox"/> DES <input checked="" type="checkbox"/> 3DES <input checked="" type="checkbox"/> AES</p> <p>Local ID (optional) <input style="width: 100px;" type="text"/></p>
		<p>Callback Function</p> <p><input type="checkbox"/> Check to enable Callback function</p> <p><input type="checkbox"/> Specify the callback number</p> <p>Callback Number <input style="width: 100px;" type="text"/></p> <p><input checked="" type="checkbox"/> Check to enable Callback Budget Control</p> <p>Callback Budget <input type="text" value="30"/> minute(s)</p>
<p><input type="button" value="OK"/> <input type="button" value="Clear"/> <input type="button" value="Cancel"/></p>		

Enable this account

Check the box to enable this function.

Idle Timeout- If the dial-in user is idle over the limitation of the timer, the router will drop this connection. By default, the Idle Timeout is set to 300 seconds.

ISDN

Allow the remote ISDN dial-in connection. You can further set up Callback function below. You should set the User Name and Password of remote dial-in user below

PPTP

Allow the remote dial-in user to make a PPTP VPN connection through the Internet. You should set the User Name and Password of remote dial-in user below

IPsec Tunnel

Allow the remote dial-in user to make an IPsec VPN connection through Internet.

L2TP

Allow the remote dial-in user to make a L2TP VPN connection through the Internet. You can select to use L2TP alone or with IPsec. Select from below:

None - Do not apply the IPsec policy. Accordingly, the VPN connection employed the L2TP without IPsec policy can be viewed as one pure L2TP connection.

Nice to Have - Apply the IPsec policy first, if it is applicable during negotiation. Otherwise, the dial-in VPN connection

becomes one pure L2TP connection.

Must -Specify the IPSec policy to be definitely applied on the L2TP connection.

Specify Remote Node

Check the checkbox-You can specify the IP address of the remote dial-in user, ISDN number or peer ID (used in IKE aggressive mode).

Uncheck the checkbox-This means the connection type you select above will apply the authentication methods and security methods in the **general settings**.

Netbios Naming Packet

Pass – click it to have an inquiry for data transmission between the hosts located on both sides of VPN Tunnel while connecting.

Block – When there is conflict occurred between the hosts on both sides of VPN Tunnel in connecting, such function can block data transmission of Netbios Naming Packet inside the tunnel.

Multicast via VPN

Some programs might send multicast packets via VPN connection.

Pass – Click this button to let multicast packets pass through the router.

Block – This is default setting. Click this button to let multicast packets be blocked by the router.

User Name

This field is applicable when you select ISDN, PPTP or L2TP with or without IPSec policy above.

Password

This field is applicable when you select ISDN, PPTP or L2TP with or without IPSec policy above.

Enable Mobile One-Time Password (mOTP)

Check this box to make the authentication with mOTP function.

PIN Code – Type the code for authentication (e.g, 1234).

Secret – Use the 32 digit-secret number generated by mOTP in the mobile phone (e.g., e759bb6f0e94c7ab4fe6).

IKE Authentication Method

This group of fields is applicable for IPSec Tunnels and L2TP with IPSec Policy when you specify the IP address of the remote node. The only exception is Digital Signature (X.509) can be set when you select IPSec tunnel either with or without specify the IP address of the remote node.

Pre-Shared Key - Check the box of Pre-Shared Key to invoke this function and type in the required characters (1-63) as the pre-shared key.

Digital Signature (X.509) – Check the box of Digital Signature to invoke this function and Select one predefined Profiles set in the **VPN and Remote Access >>IPSec Peer Identity**.

IPSec Security Method

This group of fields is a must for IPSec Tunnels and L2TP with IPSec Policy when you specify the remote node. Check the Medium, DES, 3DES or AES box as the security method.

Medium - Authentication Header (AH) means data will be

authenticated, but not be encrypted. By default, this option is invoked. You can uncheck it to disable it.

High - Encapsulating Security Payload (ESP) means payload (data) will be encrypted and authenticated. You may select encryption algorithm from Data Encryption Standard (DES), Triple DES (3DES), and AES.

Local ID - Specify a local ID to be used for Dial-in setting in the LAN-to-LAN Profile setup. This item is optional and can be used only in IKE aggressive mode.

Callback Function

The callback function provides a callback service only for the ISDN dial-in user. The remote user will be charged the connection fee by the telecom.

Check to enable Callback function-Enables the callback function.

Specify the callback number-The option is for extra security. Once enabled, the router will ONLY call back to the specified Callback Number.

Check to enable callback budget control-By default, the callback function has a time restriction. Once the callback budget has been exhausted, the callback mechanism will be disabled automatically.

Callback Budget (Unit: minutes)- Specify the time budget for the dial-in user. The budget will be decreased automatically per callback connection.

5.9.6 LAN to LAN

Here you can manage LAN-to-LAN connections by maintaining a table of connection profiles. You may set parameters including specified connection direction (dial-in or dial-out), connection peer ID, connection type (VPN connection - including PPTP, IPSec Tunnel, and L2TP by itself or over IPSec) and corresponding security methods, etc.

The router supports 2 VPN tunnels and provides up to **32** profiles simultaneously. The following figure shows the summary table.

VPN and Remote Access >> LAN to LAN

LAN-to-LAN Profiles: [Set to Factory Default](#)

Index	Name	Status	Index	Name	Status
1.	???	X	17.	???	X
2.	???	X	18.	???	X
3.	???	X	19.	???	X
4.	???	X	20.	???	X
5.	???	X	21.	???	X
6.	???	X	22.	???	X
7.	???	X	23.	???	X
8.	???	X	24.	???	X
9.	???	X	25.	???	X
10.	???	X	26.	???	X
11.	???	X	27.	???	X
12.	???	X	28.	???	X
13.	???	X	29.	???	X
14.	???	X	30.	???	X
15.	???	X	31.	???	X
16.	???	X	32.	???	X

Set to Factory Default

Click to clear all indexes.

Name

Indicate the name of the LAN-to-LAN profile. The symbol ??? represents that the profile is empty.

Status

Indicate the status of individual profiles. The symbol V and X represent the profile to be active and inactive, respectively.

Click each index to edit each profile and you will get the following page. Each LAN-to-LAN profile includes 4 subgroups. If the fields gray out, it means you may leave it untouched. The following explanations will guide you to fill all the necessary fields.

For the web page is too long, we divide the page into several sections for explanation.

Profile Index : 1

1. Common Settings

Profile Name <input type="text" value="???"/> <input type="checkbox"/> Enable this profile	Call Direction <input checked="" type="radio"/> Both <input type="radio"/> Dial-Out <input type="radio"/> Dial-in <input type="checkbox"/> Always on Idle Timeout <input type="text" value="300"/> second(s) <input type="checkbox"/> Enable PING to keep alive PING to the IP <input type="text"/>
VPN Dial-Out Through <input type="text" value="WAN1 First"/> Netbios Naming Packet <input checked="" type="radio"/> Pass <input type="radio"/> Block Multicast via VPN <input type="radio"/> Pass <input checked="" type="radio"/> Block (for some IGMP,IP-Camera,DHCP Relay...etc.)	

2. Dial-Out Settings

Type of Server I am calling <input checked="" type="radio"/> ISDN <input type="radio"/> PPTP <input type="radio"/> IPsec Tunnel <input type="radio"/> L2TP with IPsec Policy <input type="text" value="None"/>	Link Type <input type="text" value="64k bps"/> Username <input type="text" value="???"/> Password <input type="text"/> PPP Authentication <input type="text" value="PAP/CHAP"/> VJ Compression <input checked="" type="radio"/> On <input type="radio"/> Off
Dial Number for ISDN or Server IP/Host Name for VPN. (such as 5551234, draytek.com or 123.45.67.89) <input type="text"/>	IKE Authentication Method <input checked="" type="radio"/> Pre-Shared Key IKE Pre-Shared Key <input type="text"/> <input type="radio"/> Digital Signature(X.509) <input type="text" value="None"/>
	IPsec Security Method <input checked="" type="radio"/> Medium(AH) <input type="radio"/> High(ESP) <input type="text" value="DES without Authentication"/> <input type="button" value="Advanced"/>
	Index(1-15) in Schedule Setup: <input type="text"/> , <input type="text"/> , <input type="text"/> , <input type="text"/>
	Callback Function (CBCP) <input type="checkbox"/> Require Remote to Callback <input type="checkbox"/> Provide ISDN Number to Remote

- Profile Name** Specify a name for the profile of the LAN-to-LAN connection.
- Enable this profile** Check here to activate this profile.
- Netbios Naming Packet** **Pass** – click it to have an inquiry for data transmission between the hosts located on both sides of VPN Tunnel while connecting.
Block – When there is conflict occurred between the hosts on both sides of VPN Tunnel in connecting, such function can block data transmission of Netbios Naming Packet inside the tunnel.
- VPN Dial-Out Through** Use the drop down menu to choose a proper WAN interface for this profile. This setting is useful for dial-out only.

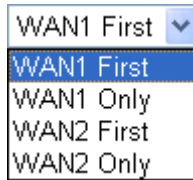

WAN1 First - While connecting, the router will use WAN1 as the first channel for VPN connection. If WAN1 fails, the router will use another WAN interface instead.

WAN1 Only - While connecting, the router will use WAN1 as the only channel for VPN connection.

WAN2 First - While connecting, the router will use WAN2 as the first channel for VPN connection. If WAN2 fails, the router will use another WAN interface instead.

WAN2 Only - While connecting, the router will use WAN2 as the only channel for VPN connection.

Call Direction

Specify the allowed call direction of this LAN-to-LAN profile.

Both-initiator/responder

Dial-Out- initiator only

Dial-In- responder only

Always On or Idle Timeout

Always On-Check to enable router always keep VPN connection.

Idle Timeout: The default value is 300 seconds. If the connection has been idled over the value, the router will drop the connection.

Enable PING to keep alive

This function is to help the router to determine the status of IPSec VPN connection, especially useful in the case of abnormal VPN IPSec tunnel disruption. For details, please refer to the note below. Check to enable the transmission of PING packets to a specified IP address.

PING to the IP

Enter the IP address of the remote host that located at the other-end of the VPN tunnel.

Enable PING to Keep Alive is used to handle abnormal IPSec VPN connection disruption. It will help to provide the state of a VPN connection for router's judgment of redial.

Normally, if any one of VPN peers wants to disconnect the connection, it should follow a serial of packet exchange procedure to inform each other. However, if the remote peer disconnect without notice, Vigor router will by no where to know this situation. To resolve this dilemma, by continuously sending PING packets to the remote host, the Vigor router can know the true existence of this VPN connection and react accordingly. This is independent of DPD (dead peer detection).

ISDN

Build ISDN LAN-to-LAN connection to remote network. You should set up Link Type and identity like User Name

and Password for the authentication of remote server. You can further set up Callback (CBCP) function below.

PPTP Build a PPTP VPN connection to the server through the Internet. You should set the identity like User Name and Password below for the authentication of remote server.

IPSec Tunnel Build an IPSec VPN connection to the server through Internet.

L2TP with IPSec Policy Build a L2TP VPN connection through the Internet. You can select to use L2TP alone or with IPSec. Select from below:

None: Do not apply the IPSec policy. Accordingly, the VPN connection employed the L2TP without IPSec policy can be viewed as one pure L2TP connection.

Nice to Have: Apply the IPSec policy first, if it is applicable during negotiation. Otherwise, the dial-out VPN connection becomes one pure L2TP connection.

Must: Specify the IPSec policy to be definitely applied on the L2TP connection.

Link Type There are three link types provided here for different purpose. **Disable** disables the LAN to LAN dial-out function. **64Kbps** allows you to use one channel for Internet access. **128Kbps** allows you to use both channels for Internet access. **BOD** stands for bandwidth-on-demand. The router will use only one channel in low traffic situations. Once the single channel bandwidth is fully used, the other channel will be activated automatically through the dialup.



User Name This field is applicable when you select ISDN, PPTP or L2TP with or without IPSec policy above.

Password This field is applicable when you select ISDN, PPTP or L2TP with or without IPSec policy above.

PPP Authentication This field is applicable when you select ISDN, PPTP or L2TP with or without IPSec policy above. PAP/CHAP is the most common selection due to wild compatibility.

VJ compression This field is applicable when you select ISDN, PPTP or L2TP with or without IPSec policy above. VJ Compression is used for TCP/IP protocol header compression. Normally set to **Yes** to improve bandwidth utilization.

IKE Authentication Method This group of fields is applicable for IPSec Tunnels and L2TP with IPSec Policy.

Pre-Shared Key - Input 1-63 characters as pre-shared key.

Digital Signature (X.509) - Select one predefined Profiles set in the **VPN and Remote Access >>IPSec Peer Identity**.

IPSec Security Method

This group of fields is a must for IPSec Tunnels and L2TP with IPSec Policy.

Medium

Medium (AH) means data will be authenticated, but not be encrypted. By default, this option is active.

High (ESP-Encapsulating Security Payload)- means payload (data) will be encrypted and authenticated. Select from below:

DES without Authentication -Use DES encryption algorithm and not apply any authentication scheme.

DES with Authentication-Use DES encryption algorithm and apply MD5 or SHA-1 authentication algorithm.

3DES without Authentication-Use triple DES encryption algorithm and not apply any authentication scheme.

3DES with Authentication-Use triple DES encryption algorithm and apply MD5 or SHA-1 authentication algorithm.

AES without Authentication-Use AES encryption algorithm and not apply any authentication scheme.

AES with Authentication-Use AES encryption algorithm and apply MD5 or SHA-1 authentication algorithm.

Advanced

Specify mode, proposal and key life of each IKE phase, Gateway etc.

The window of advance setup is shown as below:

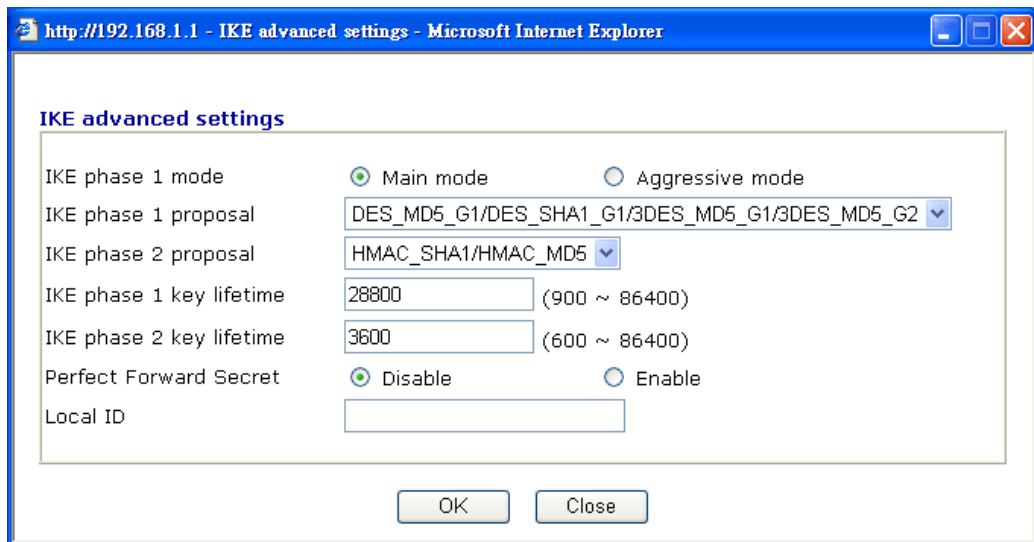

IKE phase 1 mode -Select from **Main** mode and **Aggressive** mode. The ultimate outcome is to exchange security proposals to create a protected secure channel. **Main** mode is more secure than **Aggressive** mode since more exchanges are done in a secure channel to set up the IPSec session. However, the **Aggressive** mode is faster.

The default value in Vigor router is Main mode.

IKE phase 1 proposal-To propose the local available authentication schemes and encryption algorithms to the VPN peers, and get its feedback to find a match. Two combinations are available for Aggressive mode and nine for **Main** mode. We suggest you select the combination that covers the most schemes.

IKE phase 2 proposal-To propose the local available algorithms to the VPN peers, and get its feedback to find a match. Three combinations are available for both modes. We suggest you select the combination that covers the most algorithms.

IKE phase 1 key lifetime-For security reason, the lifetime of key should be defined. The default value is 28800 seconds. You may specify a value in between 900 and 86400 seconds.

IKE phase 2 key lifetime-For security reason, the lifetime of key should be defined. The default value is 3600 seconds. You may specify a value in between 600 and 86400 seconds.

Perfect Forward Secret (PFS)-The IKE Phase 1 key will be reused to avoid the computation complexity in phase 2. The default value is inactive this function.

Local ID-In **Aggressive** mode, Local ID is on behalf of the IP address while identity authenticating with remote VPN server. The length of the ID is limited to 47 characters.

Callback Function

The callback function provides a callback service as a part of PPP suite only for the ISDN dial-in user. The router owner will be charged the connection fee by the telecom.

Require Remote to Callback-Enable this to let the router to require the remote peer to callback for the connection afterwards.

Provide ISDN Number to Remote-In the case that the remote peer requires the Vigor router to callback, the local ISDN number will be provided to the remote peer. Check here to allow the Vigor router to send the ISDN number to the remote router.

3. Dial-In Settings

Allowed Dial-In Type <input checked="" type="checkbox"/> ISDN <input checked="" type="checkbox"/> PPTP <input checked="" type="checkbox"/> IPsec Tunnel <input checked="" type="checkbox"/> L2TP with IPsec Policy <input type="text" value="None"/> <input type="checkbox"/> Specify ISDN CLID or Remote VPN Gateway Peer ISDN Number or Peer VPN Server IP <input type="text"/> or Peer ID <input type="text"/>	Username <input type="text" value="???"/> Password <input type="text"/> VJ Compression <input checked="" type="radio"/> On <input type="radio"/> Off IKE Authentication Method <input checked="" type="checkbox"/> Pre-Shared Key IKE Pre-Shared Key <input type="text"/> <input type="checkbox"/> Digital Signature(X.509) <input type="text" value="None"/> IPsec Security Method <input checked="" type="checkbox"/> Medium(AH) High(ESP) <input checked="" type="checkbox"/> DES <input checked="" type="checkbox"/> 3DES <input checked="" type="checkbox"/> AES Callback Function (CBCP) <input type="checkbox"/> Enable Callback Function <input type="checkbox"/> Use the Following Number to Callback Callback Number <input type="text"/> Callback Budget <input type="text" value="0"/> minute(s)
--	--

4. TCP/IP Network Settings

My WAN IP <input type="text" value="0.0.0.0"/> Remote Gateway IP <input type="text" value="0.0.0.0"/> Remote Network IP <input type="text" value="0.0.0.0"/> Remote Network Mask <input type="text" value="255.255.255.0"/> <input type="button" value="More"/>	RIP Direction <input type="text" value="Disable"/> From first subnet to remote network, you have to do <input type="text" value="Route"/> <input type="checkbox"/> Change default route to this VPN tunnel (Only single WAN supports this)
---	---

Allowed Dial-In Type

Determine the dial-in connection with different types.

ISDN

Allow the remote ISDN LAN-to-LAN connection. You should set the User Name and Password of remote dial-in user below. In addition, you can further set up Callback function below.

PPTP

Allow the remote dial-in user to make a PPTP VPN connection through the Internet. You should set the User Name and Password of remote dial-in user below.

IPsec Tunnel

Allow the remote dial-in user to trigger an IPsec VPN connection through Internet.

L2TP

Allow the remote dial-in user to make a L2TP VPN connection through the Internet. You can select to use L2TP alone or with IPsec. Select from below:

None - Do not apply the IPsec policy. Accordingly, the VPN connection employed the L2TP without IPsec policy can be viewed as one pure L2TP connection.

Nice to Have - Apply the IPsec policy first, if it is applicable during negotiation. Otherwise, the dial-in VPN connection becomes one pure L2TP connection.

	<p>Must - Specify the IPSec policy to be definitely applied on the L2TP connection.</p>
Specify CLID or Remote VPN Gateway	<p>You can specify the IP address of the remote dial-in user or peer ID (should be the same with the ID setting in dial-in type) by checking the box. Enter Peer ISDN number if you select ISDN above. Also, you should further specify the corresponding security methods on the right side.</p> <p>If you uncheck the checkbox, the connection type you select above will apply the authentication methods and security methods in the general settings.</p>
User Name	<p>This field is applicable when you select ISDN, PPTP or L2TP with or without IPSec policy above.</p>
Password	<p>This field is applicable when you select ISDN, PPTP or L2TP with or without IPSec policy above.</p>
VJ Compression	<p>VJ Compression is used for TCP/IP protocol header compression. This field is applicable when you select ISDN, PPTP or L2TP with or without IPSec policy above.</p>
IKE Authentication Method	<p>This group of fields is applicable for IPSec Tunnels and L2TP with IPSec Policy when you specify the IP address of the remote node. The only exception is Digital Signature (X.509) can be set when you select IPSec tunnel either with or without specify the IP address of the remote node.</p> <p>Pre-Shared Key - Check the box of Pre-Shared Key to invoke this function and type in the required characters (1-63) as the pre-shared key.</p> <p>Digital Signature (X.509) –Check the box of Digital Signature to invoke this function and select one predefined Profiles set in the VPN and Remote Access >>IPSec Peer Identity.</p>
IPSec Security Method	<p>This group of fields is a must for IPSec Tunnels and L2TP with IPSec Policy when you specify the remote node.</p> <p>Medium- Authentication Header (AH) means data will be authenticated, but not be encrypted. By default, this option is active.</p> <p>High- Encapsulating Security Payload (ESP) means payload (data) will be encrypted and authenticated. You may select encryption algorithm from Data Encryption Standard (DES), Triple DES (3DES), and AES.</p>
Callback Function	<p>The callback function provides a callback service only for the ISDN LAN-to-LAN connection. The remote user will be charged the connection fee by the telecom.</p> <p>Check to enable Callback function-Enables the callback function.</p> <p>Callback number-The option is for extra security. Once enabled, the router will ONLY call back to the specified Callback Number.</p>

Callback budget- By default, the callback function has limitation of callback period. Once the callback budget is exhausted, the function will be disabled automatically.

Callback Budget (Unit: minutes)- Specify the time budget for the dial-in user. The budget will be decreased automatically per callback connection. The default value 0 means no limitation of callback period.

My WAN IP

This field is only applicable when you select ISDN, PPTP or L2TP with or without IPsec policy above. The default value is 0.0.0.0, which means the Vigor router will get a PPP IP address from the remote router during the IPCP negotiation phase. If the PPP IP address is fixed by remote side, specify the fixed IP address here. Do not change the default value if you do not select ISDN, PPTP or L2TP.

Remote Gateway IP

This field is only applicable when you select ISDN, PPTP or L2TP with or without IPsec policy above. The default value is 0.0.0.0, which means the Vigor router will get a remote Gateway PPP IP address from the remote router during the IPCP negotiation phase. If the PPP IP address is fixed by remote side, specify the fixed IP address here. Do not change the default value if you do not select ISDN, PPTP or L2TP.

**Remote Network IP/
Remote Network Mask**

Add a static route to direct all traffic destined to this Remote Network IP Address/Remote Network Mask through the VPN connection. For IPsec, this is the destination clients IDs of phase 2 quick mode.

More

Add a static route to direct all traffic destined to more Remote Network IP Addresses/ Remote Network Mask through the VPN connection. This is usually used when you find there are several subnets behind the remote VPN router.

RIP Direction

The option specifies the direction of RIP (Routing Information Protocol) packets. You can enable/disable one of direction here. Herein, we provide four options: TX/RX Both, TX Only, RX Only, and Disable.

**From first subnet to
remote network, you have
to do**

If the remote network only allows you to dial in with single IP, please choose **NAT**, otherwise choose **Route**.

**Change default route to
this VPN tunnel**

Check this box to change the default route with this VPN tunnel. Be aware that this setting is available only for one WAN interface is enabled. It is not available when both WAN interfaces are enabled. You have to disable one WAN interface (WAN 1 or WAN 2) on **WAN >> General Setup** for enabling such setting.

5.9.7 Connection Management

You can find the summary table of all VPN connections. You may disconnect any VPN connection by clicking **Drop** button. You may also aggressively Dial-out by using Dial-out Tool and clicking **Dial** button.

VPN and Remote Access >> Connection Management

Dial-out Tool Refresh Seconds :

VPN Connection Status

Current Page: 1 Page No.

VPN	Type	Remote IP	Virtual Network	Tx Pkts	Tx Rate (Bps)	Rx Pkts	Rx Rate (Bps)	UpTime

xxxxxxx : Data is encrypted.
xxxxxxx : Data isn't encrypted.

Dial

Click this button to execute dial out function.

Refresh Seconds

Choose the time for refresh the dial information among 5, 10, and 30.

Refresh

Click this button to refresh the whole connection status.

5.10 Certificate Management

A digital certificate works as an electronic ID, which is issued by a certification authority (CA). It contains information such as your name, a serial number, expiration dates etc., and the digital signature of the certificate-issuing authority so that a recipient can verify that the certificate is real. Here Vigor router support digital certificates conforming to standard X.509.

Any entity wants to utilize digital certificates should first request a certificate issued by a CA server. It should also retrieve certificates of other trusted CA servers so it can authenticate the peer with certificates issued by those trusted CA servers.

Here you can manage generate and manage the local digital certificates, and set trusted CA certificates. Remember to adjust the time of Vigor router before using the certificate so that you can get the correct valid period of certificate.

Below shows the menu items for Certificate Management.



5.10.1 Local Certificate

[Certificate Management >> Local Certificate](#)

X509 Local Certificate Configuration

Name	Subject	Status	Modify
Local	---	---	<input type="button" value="View"/> <input type="button" value="Delete"/>

X509 Local Certificate

Generate

Click this button to open **Generate Certificate Request** window.

Certificate Management >> Local Certificate

Generate Certificate Request

Subject Alternative Name

Type: IP Address (dropdown)
IP:

Subject Name

Country (C):
State (ST):
Location (L):
Organization (O):
Organization Unit (OU):
Common Name (CN):
Email (E):

Key Type: RSA (dropdown)
Key Size: 1024 Bit (dropdown)

Type in all the information that the window request. Then click **Generate** again.

Import

Click this button to import a saved file as the certification information.

Refresh

Click this button to refresh the information listed below.

View

Click this button to view the detailed settings for certificate request.

After clicking **Generate**, the generated information will be displayed on the window below:

Certificate Management >> Local Certificate

X509 Local Certificate Configuration

Name	Subject	Status	Modify
Local	/C=TW/ST=HS/O=Draytek/OU=RD/...	Requesting	<input type="button" value="View"/> <input type="button" value="Delete"/>

X509 Local Certificate Request

```
-----BEGIN CERTIFICATE REQUEST-----
MIIBnTCCAQYCAQAwXTELMakGA1UEBhMCVFcxZAJBgNVBAGTAkhhTMRawDgYDVQQK
EwdEcmF5dGVrMQswCQYDVQQLwJSRDEiMCAgCSqGSIb3DQEJARYTc3VwcG9ydEBk
cmF5dGVrLmNvbTCBnzANBgkqhkiG9w0BAQEFAA0BjQAwgYkCgYEAyZELVTvBytix
OTSZSZQdwlReltv1HnVwma/MFC0y9x+XEwNKG46jdGY1LSAvJTduHH9Oz4OMWx02G
mASVORTj7HbNOdYn88p1xRrQFgk8nkbMLdAqb1Ooc/1sYN/smGb4N+Pbo4VMO1VO
dKiyAPfp/202OWsCddxh/HzZ3Ys8m60CAwEAaAAAMAOGCSqGSIb3DQEBBQUAA4GB
AGNB9071V44sgXwiWnXHJvdFLD0dwcQ01ZL1XRn+OVdheJjvaISCgiqzJQCkaDQ7
nacBqEc1W0chKzES0dyDc8mtIf7k+i045SeuY7nxsWxvPIOn31JMjGMZvQSVrTYu
sOvJGBHHwKSkWb1R&ZL5xvHjDoMX16czT1ybedZSsrJw
-----END CERTIFICATE REQUEST-----
```

5.10.2 Trusted CA Certificate

Trusted CA certificate lists three sets of trusted CA certificate.

[Certificate Management >> Trusted CA Certificate](#)

X509 Trusted CA Certificate Configuration

Name	Subject	Status	Modify	
Trusted CA-1	---	---	<input type="button" value="View"/>	<input type="button" value="Delete"/>
Trusted CA-2	---	---	<input type="button" value="View"/>	<input type="button" value="Delete"/>
Trusted CA-3	---	---	<input type="button" value="View"/>	<input type="button" value="Delete"/>

To import a pre-saved trusted CA certificate, please click **IMPORT** to open the following window. Use **Browse...** to find out the saved text file. Then click **Import**. The one you imported will be listed on the Trusted CA Certificate window. Then click **Import** to use the pre-saved file.

[Certificate Management >> Trusted CA Certificate](#)

Import X509 Trusted CA Certificate

Select a trusted CA certificate file.

Click [Import](#) to upload the certification.

For viewing each trusted CA certificate, click **View** to open the certificate detail information window. If you want to delete a CA certificate, choose the one and click **Delete** to remove all the certificate information.

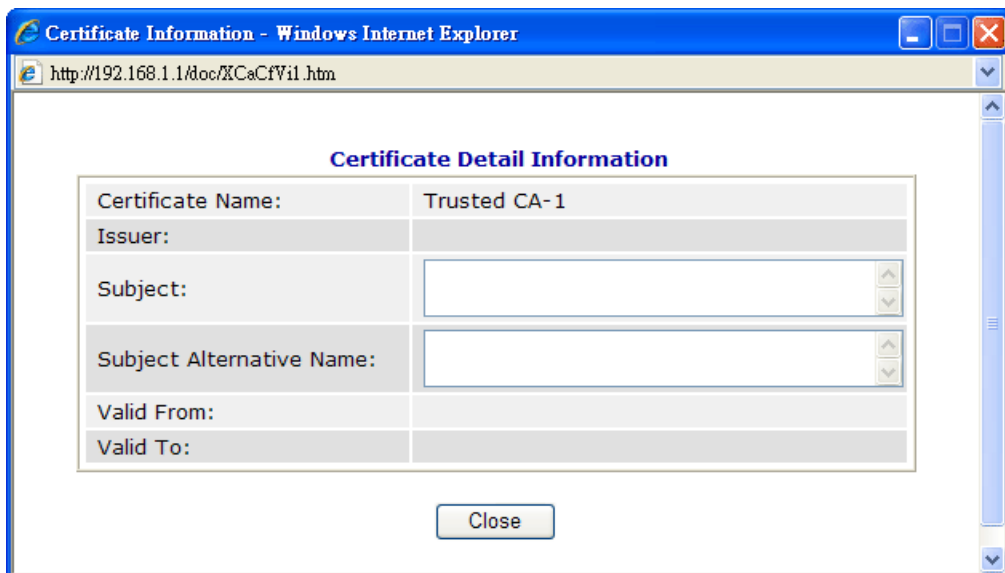

5.10.3 Certificate Backup

Local certificate and Trusted CA certificate for this router can be saved within one file. Please click **Backup** on the following screen to save them. If you want to set encryption password for these certificates, please type characters in both fields of **Encrypt password** and **Confirm password**.

Also, you can use **Restore** to retrieve these two settings to the router whenever you want.

[Certificate Management >> Certificate Backup](#)

Certificate Backup / Restoration

Backup

Encrypt password:

Confirm password:

Click to download certificates to your local PC as a file.

Restoration

Select a backup file to restore.

Decrypt password:

Click to upload the file.

5.11 ISDN

5.11.1 Basic Concept

ISDN means integrated services digital network that is an international communications standard for sending voice, video, and data over digital telephone lines or normal telephone wires.

Below shows the menu items for ISDN.

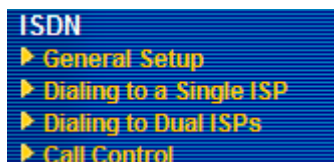

Data call function is supported only when ISDN2 port is configured as ISDN-TE mode. In normal case, the ISDN2 port is configured as ISDN-TE mode in default. If it is configured as ISDN-S0 mode, the data call function will not be supported and **Dialing to a Single ISP**, **Dialing to Dual ISPs** and **Call Control** functions will not be available.

In addition, if ISDN1 port is configured as ISDN-TE mode and ISDN2 is configured as ISDN2-S0 mode, the data call function will not be supported and **Dialing to a Single ISP**, **Dialing to Dual ISPs** and **Call Control** functions will not be available, either.

5.11.2 General Setup

This page provides some basic ISDN settings such as enabling the ISDN port or not, MSN numbers and blocked MSN numbers, etc.

ISDN >> General Setup

ISDN Setup

ISDN Port	<input checked="" type="radio"/> Enable <input type="radio"/> Disable	Blocked MSN numbers for the router 1. <input type="text"/> 2. <input type="text"/> 3. <input type="text"/> 4. <input type="text"/> 5. <input type="text"/>
Country Code	<input type="text" value="International"/>	
D-Channel Mode		
ISDN1	<input type="radio"/> Point-to-Point <input checked="" type="radio"/> Point-to-Multipoint	
ISDN2	<input type="radio"/> Point-to-Point <input checked="" type="radio"/> Point-to-Multipoint	
Own Number	<input type="text"/>	

"Own Number" means that the router will tell the remote end the ISDN number when it's placing an outgoing call.

Index	MSN numbers for the router	Answer mode	Phone CLIR/CLIP
0.	<input type="text"/>	Auto Attendant	<input type="checkbox"/> <input type="checkbox"/>
1.	<input type="text"/>	Auto Attendant	<input type="checkbox"/> <input type="checkbox"/>
2.	<input type="text"/>	Auto Attendant	<input type="checkbox"/> <input type="checkbox"/>
3.	<input type="text"/>	Auto Attendant	<input type="checkbox"/> <input type="checkbox"/>
4.	<input type="text"/>	Auto Attendant	<input type="checkbox"/> <input type="checkbox"/>
5.	<input type="text"/>	Auto Attendant	<input type="checkbox"/> <input type="checkbox"/>
6.	<input type="text"/>	Auto Attendant	<input type="checkbox"/> <input type="checkbox"/>
7.	<input type="text"/>	Auto Attendant	<input type="checkbox"/> <input type="checkbox"/>
8.	<input type="text"/>	Auto Attendant	<input type="checkbox"/> <input type="checkbox"/>
9.	<input type="text"/>	Auto Attendant	<input type="checkbox"/> <input type="checkbox"/>

"MSN Numbers" means that the router is able to accept number-matched incoming calls. In addition, MSN service should be supported by the local ISDN network provider.

ISDN Port

Click **Enable** to open the ISDN port and **Disable** to close it.

Country Code

For proper operation on your local ISDN network, you should choose the correct country code.

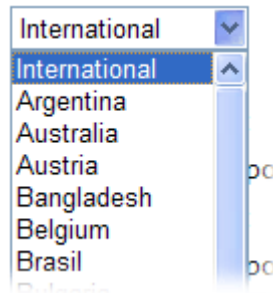

D-Channel Mode

It allows you to configure ISDN layer2 protocol as:

Point-to-Point - Configure ISDN port to use static TEI

(Terminal Endpoint Identifier).

Point-to-Multipoint - Configure ISDN port to use Dynamic TEI.

Own Number

Enter your ISDN number. Every outgoing call will carry the number to the receiver.

Blocked MSN Numbers for the router

Enter the specified MSN number into the fields to prevent the router from dialing the specific MSN number.

MSN Numbers for the Router

MSN Numbers mean that the router is able to accept only number-matched incoming calls. In addition, MSN services should be supported by local ISDN network provider. The router provides three fields for MSN numbers. Note that MSN services must be acquired from your local telecommunication operators. By default, MSN function is disabled. If you leave the fields blank, all incoming calls will be accepted without number matching.

Answer mode

Specify the way to process incoming phone calls which matched the MSN number for router.

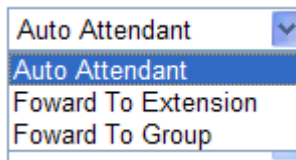

Auto Attendant - The incoming call would be picked by router automatically. You could hear IVR voice to remind you to dial extension number you want to reach.

Forward to Extension - The incoming call would be forwarded to the extension number you setup directly.

Forward to Group - If you have setup group extension number in web page " Hunt Group", the incoming call could be forwarded to the group extension number you selected.

Phone CLIR/CLIP

Check this box to hide or present the caller ID to remote user.

Example:

Below shows an example of TE port MSN number:

Index	MSN numbers for the router	Answer mode	Phone CLIR/CLIP
0.	5972727	Auto Attendant	<input type="checkbox"/> <input type="checkbox"/>
1.	5972728	Foward To Extension 1 - 100 Extension	<input type="checkbox"/> <input checked="" type="checkbox"/>
2.	5972729	Foward To Group 1 - 300 Group	<input type="checkbox"/> <input checked="" type="checkbox"/>
3.		Auto Attendant	<input type="checkbox"/> <input type="checkbox"/>
4.		Auto Attendant	<input type="checkbox"/> <input type="checkbox"/>
5.		Auto Attendant	<input type="checkbox"/> <input type="checkbox"/>
6.		Auto Attendant	<input type="checkbox"/> <input type="checkbox"/>
7.		Auto Attendant	<input type="checkbox"/> <input type="checkbox"/>
8.		Auto Attendant	<input type="checkbox"/> <input type="checkbox"/>
9.		Auto Attendant	<input type="checkbox"/> <input type="checkbox"/>

"MSN Numbers" means that the router is able to accept number-matched incoming calls. In addition, MSN service should be supported by the local ISDN network provider.

Refer to the following explanation:

- If you setup "MSN numbers for the router" as the above figure, it means the Vigor router only accepts MSN numbers of **5972727 / 5972728 / 5972729**.
- If someone dials to the router with **5972727**, the call would be picked up automatically. You could hear IVR voice to remind you to dial the extension number you want to reach.
- If someone dials to the router with **5972728**, the call would be forwarded to extension 100 directly.
- If someone dials to the router with **5972729**, the call would be forwarded to group extension 300.
- If you use a phone with extension 100 to dial an ISDN call, the remote ISDN phone would see the **caller ID: 5972728** (for the Phone CLIP is checked).
- If you use any extension number included in Group extension 300 to dial an ISDN call, the remote ISDN phone would see the **caller ID: 5972729** (for the Phone CLIP is checked).

5.11.3 Dial to Single ISP

Select **Dialing to a Single ISP** if you access the Internet via a single ISP.

[ISDN >> Dialing to a Single ISP](#)

Single ISP

ISP Access Setup	PPP/MP Setup
ISP Name <input type="text"/>	Link Type <input type="text" value="Dialup BOD"/>
Dial Number <input type="text"/>	PPP Authentication <input type="text" value="PAP or CHAP"/>
Username <input type="text"/>	Idle Timeout <input type="text" value="180"/> second(s)
Password <input type="text"/>	IP Address Assignment Method (IPCP)
<input type="checkbox"/> Require ISP callback (CBCP)	Fixed IP <input type="radio"/> Yes <input checked="" type="radio"/> No (Dynamic IP)
Index(1-15) in Schedule Setup:	Fixed IP Address <input type="text"/>
=> <input type="text"/> , <input type="text"/> , <input type="text"/> , <input type="text"/>	

ISP Access Setup

ISP Name - Enter your ISP name such as Seednet, Hinet and so on.

Dial Number - Enter the ISDN access number provided by your ISP.

Username - Enter the username provided by your ISP.

Password - Enter the password provided by your ISP.

Require ISP Callback (CBCP) - If your ISP supports the callback function, check this box to activate the Callback Control Protocol during the PPP negotiation.

Scheduler (1-15) - Enter the index of schedule profiles to control the Internet access according to the preconfigured schedules. Refer to section **Applications >> Schedule** for detailed configuration.

PPP/MP Setup

Link Type - There are three link types provided here for different purpose. **Link Disable** disables the ISDN dial-out function. **Dialup 64Kbps** allows you to use one ISDN B channel for Internet access. **Dialup 128Kbps** allows you to use both ISDN B channels for Internet access. **Dialup BOD** stands for bandwidth-on-demand. The router will use only one B channel in low traffic situations. Once the single B channel bandwidth is fully used, the other B channel will be activated automatically through the dialup. For more detailed BOD parameter settings, please refer to the section of **Call Control**.

PPP Authentication - PAP only allows you to configure the PPP session to use the PAP protocol to negotiate the username and password with the ISP. **PAP or CHAP** is to configure the PPP session to use the PAP or CHAP protocols to negotiate the username and password with the ISP.

Idle Timeout - Idle timeout means the router will be

disconnect after being idle for a preset amount of time. The default is 180 seconds. If you set the time to 0, the ISDN connection to the ISP will always remain on.

IP Address Assignment Method (IPCP)

In most environments, you should not change these settings as most ISPs provide a dynamic IP address for the router when it connects to the ISP. If your ISP provides a fixed IP address, check **Yes** and enter the IP address in the field of **Fixed IP Address**.

5.11.4 Dial to Dual ISPs

Select **Dialing to Dual ISPs** if you have more than one ISP. You will be able to dial to both ISPs at the same time. This is mainly for those ISPs that do not support Multiple-Link PPP (ML-PPP). In such cases, dialing to two ISPs can increase the bandwidth utilization of the ISDN channels to 128kbps data speed.

[ISDN >> Dialing to Dual ISPs](#)

Dual ISP	
<p>Common Settings</p> <p>1. <input type="checkbox"/> Enable Dual ISPs Function</p> <p>2. <input type="checkbox"/> Require ISP callback (CBCP)</p>	<p>PPP/MP Setup</p> <p>Link Type: <input type="text" value="Dialup BOD"/></p> <p>PPP Authentication: <input type="text" value="PAP or CHAP"/></p> <p>Idle Timeout: <input type="text" value="180"/> second(s)</p>
<p>Primary ISP Setup</p> <p>ISP Name: <input type="text"/></p> <p>Dial Number: <input type="text"/></p> <p>Username: <input type="text"/></p> <p>Password: <input type="text"/></p> <p>IP Address Assignment Method (IPCP)</p> <p>Fixed IP: <input type="radio"/> Yes <input checked="" type="radio"/> No (Dynamic IP)</p> <p>Fixed IP Address: <input type="text"/></p>	<p>Secondary ISP Setup</p> <p>ISP Name: <input type="text"/></p> <p>Dial Number: <input type="text"/></p> <p>Username: <input type="text" value="84005755@hinet.net"/></p> <p>Password: <input type="text" value="*****"/></p> <p>IP Address Assignment Method (IPCP)</p> <p>Fixed IP: <input type="radio"/> Yes <input checked="" type="radio"/> No (Dynamic IP)</p> <p>Fixed IP Address: <input type="text"/></p>
<input type="button" value="OK"/>	

Common Settings

Enable Dual ISPs Function - Check to enable the Dual ISPs function. **Require ISP Callback (CBCP)** -If your ISP supports the callback function, check this box to activate the Callback Control Protocol during the PPP negotiation.

PPP/MP Setup

Link Type – There are three link types provided here for different purpose. **Link Disable** disables the ISDN dial-out function. **Dialup 128Kbps** allows you to use both ISDN B channels for Internet access. **Dialup BOD** stands for bandwidth-on-demand. The router will use only one B channel in low traffic situations. Once the single B channel bandwidth is fully used, the other B channel will be activated automatically through the dialup.

PPP Authentication - PAP only allows you to configure the PPP session to use the PAP protocol to negotiate the username and password with the ISP. **PAP or CHAP** can

configure the PPP session to use the PAP or CHAP protocols to negotiate the username and password with the ISP.

Idle Timeout - Idle timeout means the router will be disconnect after being idle for a preset amount of time. The default is 180 seconds. If you set the time to 0, the ISDN connection to the ISP will always remain on.

Primary ISP Setup

ISP Name - Enter your ISP name.

Dial Number -Enter the ISDN access number provided by your ISP.

Username - Enter the username provided by your ISP.

Password - Enter the password provided by your ISP.

IP Address Assignment Method (IPCP) for primary ISP setup

In most environments, you should not change these settings as most ISPs provide a dynamic IP address for the router when it connects to the ISP. If your ISP provides a fixed IP address, check **Yes** and enter the IP address in the field of **Fixed IP Address**.

Secondary ISP Setup)

ISP Name - Enter the secondary ISP name.

Dial Number -Enter the ISDN access number provided by the ISP.

Username - Enter the username provided by your ISP.

Password - Enter the password provided by your ISP.

IP Address Assignment Method (IPCP) for secondary ISP setup

In most environments, you should not change these settings as most ISPs provide a dynamic IP address for the router when it connects to the ISP. If your ISP provides a fixed IP address, check **Yes** and enter the IP address in the field of **Fixed IP Address**.

5.11.5 Call Control

Some applications require that the router be remotely activated, or be able to dial up to the ISP via the ISDN interface. Vigor routers provide this feature by allowing user to make a phone call to the router and then ask it to dial up to the ISP. Accordingly, a teleworker can access the remote network to retrieve resources. Of course, a fixed IP address is required for WAN connection and some internal network resource has to be exposed for remote users, such as FTP, and WWW.

ISDN >> Call Control

Call Control Setup

Dial Retry	<input type="text" value="0"/> times	Remote Activation	<input type="text"/>
Dial Delay Interval	<input type="text" value="0"/> second(s)		

PPP/MP Dial-Out Setup

Basic Setup		Bandwidth On Demand (BOD) Setup	
Link Type	<input type="text" value="Dialup BOD"/> ▼	High Water Mark	<input type="text" value="7000"/> cps
PPP Authentication	<input type="text" value="PAP or CHAP"/> ▼	High Water Time	<input type="text" value="30"/> second(s)
TCP Header Compression	<input type="text" value="None"/> ▼	Low Water Mark	<input type="text" value="6000"/> cps
Idle Timeout	<input type="text" value="180"/> second(s)	Low Water Time	<input type="text" value="30"/> second(s)

OK

Call Control Setup

Dial Retry - It specifies the dial retry counts per triggered packet. A triggered packet is the packet whose destination is outside the local network. The default setting is no dial retry. If set to 5, for each triggered packet, the router will dial 5 times until it is connected to the ISP or remote access router.

Dial Delay Interval - It specifies the interval between dialup retries. By default, the interval is 0 second.

Remote Activation – It can help users who would like to access the server which is off the Internet in the head office. To remotely make the server to be available on the Internet, i.e. make the router in the head office activating its Internet access either by dialing-up or starting broadband connection, users can make a regular phone call (the number is set in the Remote Activation field) to the router as signaling it for activation. The phone call will be soon disconnected once the router is on line.

Note that **Dialing to a Single ISP** should be pre-configured properly.

Basic Setup

Link Type - Because ISDN has two B channels (64Kbps/per channel), you can specify whether you would like to have single B channel, two B channels or BOD (Bandwidth on Demand). Four options are available: Link Disable, Dialup 64Kbps, Dialup 128Kbps, Dialup BOD.

Link Type

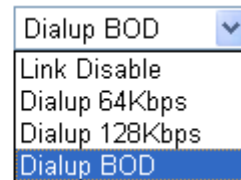

PPP Authentication - It specifies the PPP authentication method for PPP/MP connections. Normally you can set it to PAP/CHAP for better compatibility.

TCP Header Compression - VJ Compression: It is used for TCP/IP protocol header compression. Normally it is set to Yes to improve bandwidth utilization.

Idle Timeout - Because our ISDN link type is **Dial On Demand**, the connection will be initiated only when needed.

Bandwidth-On-Demand (BOD) Setup

Bandwidth-On-Demand is for Multiple-Link PPP (ML-PPP or MP). The parameters are only applied when you set the **Link Type** to **Dialup BOD**. The ISDN usually use one B channel to access the Internet or remote network when you choose the Dialup BOD link type. The router will use the parameters here to decide on when you activate/drop the additional B channel. Note that **cps** (characters-per-second) measures the total link utilization.

High Water Mark and High Water Time - These parameters specify the situation in which the second channel will be activated. With the first connected channel, if its utilization exceeds the High Water Mark and such a channel is being used over the High Water Time, the additional channel will be activated. Thus, the total link speed will be 128kbps (two B channels).

Low Water Mark and Low Water Time - These parameters specify the situation in which the second channel will be dropped. In terms of the two B channels, if their utilization is under the Low Water Mark and these two channels are being used over the High Water Time, the additional channel will be dropped. As a result, the total link speed will be 64kbps (one B channel).

5.12 IP PBX

IP PBX (***IP -Private Branch eXchange***) is a private telephone network used within an enterprise. Users of the PBX can share a certain number of outside lines for making telephone calls external to the PBX.

IP PBX integrates the benefits of VoIP and transfers the message from IP phone into the data that can be accepted by traditional PBX through IP network. It is a new platform that enterprises can use data network to deliver voice. Additionally, to move the IP phone set(s), users just need to plug into another network connector. Such thing simplifies the procedure of moving, increasing, changing and deleting phone settings; also it can join with other system such as CALL center to be a multi-functional communication platform. Moreover, it can save large cost in communication for the enterprise.

This menu can assist users to configure most of settings in IP PBX.

Below shows menu items for IP PBX:

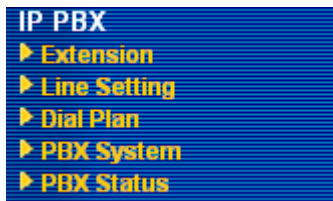

5.12.1 Extension

The system allows you to set 50 extension numbers for ISDN/SIP/Phone call. Please open **IP PBX>>Extension** to get the following page.

[IP PBX >> Extension](#)

Internal Phone Extension

Index	Ext.	Name	Email Address	Outgoing Call	Status
1.	---	---		SIP1 SIP2 SIP3 SIP4 SIP5 SIP6 ISDN2-TE	x
2.	---	---		SIP1 SIP2 SIP3 SIP4 SIP5 SIP6 ISDN2-TE	x
3.	---	---		SIP1 SIP2 SIP3 SIP4 SIP5 SIP6 ISDN2-TE	x
4.	---	---		SIP1 SIP2 SIP3 SIP4 SIP5 SIP6 ISDN2-TE	x
5.	---	---		SIP1 SIP2 SIP3 SIP4 SIP5 SIP6 ISDN2-TE	x
6.	---	---		SIP1 SIP2 SIP3 SIP4 SIP5 SIP6 ISDN2-TE	x
7.	---	---		SIP1 SIP2 SIP3 SIP4 SIP5 SIP6 ISDN2-TE	x
8.	---	---		SIP1 SIP2 SIP3 SIP4 SIP5 SIP6 ISDN2-TE	x
9.	---	---		SIP1 SIP2 SIP3 SIP4 SIP5 SIP6 ISDN2-TE	x
10.	---	---		SIP1 SIP2 SIP3 SIP4 SIP5 SIP6 ISDN2-TE	x

<< [1-10](#) | [11-20](#) | [21-30](#) | [31-40](#) | [41-50](#) >>

[Next](#) >>

Please click any number under Index to set detailed configuration.

Internal Phone Extension Index 1

Internal Phone Extension Active	<input type="radio"/> Enable <input checked="" type="radio"/> Disable
Extension Number	<input type="text" value="---"/>
Display Name	<input type="text" value="---"/>
Type	<input type="text" value="SIP"/> ▼
<input type="checkbox"/> Authentication	
Password	<input type="text" value="..."/>
E-mail Address	<input type="text"/> <input type="button" value="Send a test e-mail"/>
Voice mail Password	<input type="text" value="..."/>
MWI	<input type="radio"/> Notify User who Subscribed <input checked="" type="radio"/> Force Notify User
Outgoing Call Use	<input checked="" type="checkbox"/> SIP1 <input checked="" type="checkbox"/> SIP2 <input checked="" type="checkbox"/> SIP3 <input checked="" type="checkbox"/> SIP4 <input checked="" type="checkbox"/> SIP5 <input checked="" type="checkbox"/> SIP6 <input checked="" type="checkbox"/> ISDN2-TE <input checked="" type="checkbox"/> PSTN
Answer Mode	
No answer after	<input type="text" value="60"/> sec then <input type="text" value="Keep Ring"/> ▼
Busy then	<input type="text" value="Do Nothing"/> ▼
Not on-line	<input type="text" value="Forward To SIP Trunk"/> ▼
Forward To SIP Trunk	<input type="text" value="1 - 001"/> ▼ and dial to <input type="text"/> (20 char max.)

Internal Phone Extension Active

Click **Enable** to invoke such profile.

Extension Number

Type the number of extension for such index.

Display Name

Type a name as a display for this extension profile.

Type

Determine the type for such extension profile.

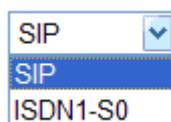

SIP – Choose this type to make such extension profile available for general IP phone.

ISDN – Choose this type to make such extension profile available for ISDN phone call.

Authentication

Check this box to make the IP PBX executing authentication while the number is dialed.

Password

Type a number for the IP PBX to execute authentication. When an IP phone connects to network, IP PBX will use such password for authentication.

E-mail Address

Type an e-mail address to receive media (voice) file sent by incoming calls.

Send a test e-mail: Click this button to send a test e-mail to the mail box you typed here.

Voice Mail Password

Type a password here. When the user want to listen the voice

mail, he/she must use such password to open it.

MWI (Message Waiting Indicator)

There are two types of MWI for users to choose. Please click the one according to the real application.

Notify User who Subscribed - The user needs to send out SUBSCRIBE message first. When IPPBX detects new voice message from some extension number or the condition of the voice message is changed, it will transfer “NOTIFY” message to the users within the valid time subscribed.

Force Notify User- The user does not send out SUBSCRIBE message automatically. The IPPBX will deliver “NOTIFY” message to the users if there is a new message or the user registers on IPPBX again.

Outgoing Call Use

There are six outside lines (SIP accounts) and two ISDN lines (available based on the Phone Setting configuration) and one PSTN for you to specify for such extension. Please check the one(s) you want.

Answer Mode

Specify the way to process incoming phone calls.

No answer after – When the incoming phone call is not picked up, it will be processed by keeping ringing, leaving voice mail, forwarding to certain extension or group, or forwarding a PSTN or mobile via SIP Trunk. Please specify the waiting time and determine the way you want to process.

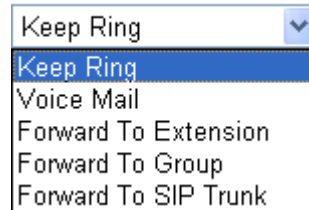

Busy then – When this extension number is busy, the incoming phone call will be processed by leaving voice mail, forwarding to certain extension or group, or forwarding to SIP Trunk. Please determine the way you want to process.

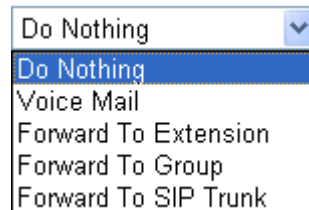

Not on-line – When this extension number is not online, the incoming phone call will be processed by leaving voice mail, forwarding to certain extension or group, or forwarding to SIP Trunk. Please determine the way you want to process.

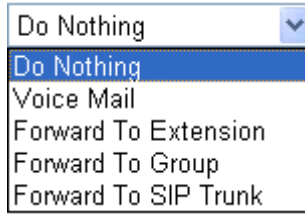

Forward TO SIP Trunk

If you choose **Forward To SIP Trunk** as the **Answer Mode** setting, you have to specify one of the SIP Trunk numbers (from 001 to 006) and type an external number in the field of **dial to**. Later, the internal phone calls will be transferred to such specified external number if they match the conditions of such profile.

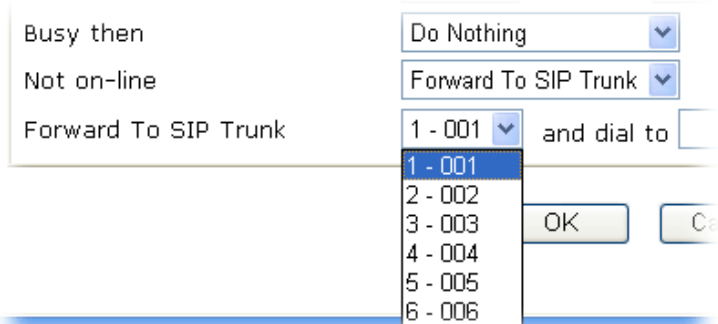

Note: The fiftieth extension profile is dedicated to Phone type.

49.	903	ISDN Phone1	SIP1 SIP2 SIP3 SIP4 SIP5 SIP6 ISDN2-TE	v
50.	901	Phone	SIP1 SIP2 SIP3 SIP4 SIP5 SIP6 ISDN2-TE	v

<< [1-10](#) | [11-20](#) | [21-30](#) | [31-40](#) | [41-50](#) >> << [Back](#)

In such page, you can configure settings to fit real requirement except for display name, type, authentication, password and not on-line.

Internal Phone Extension Index 50

Internal Phone Extension Active	<input checked="" type="radio"/> Enable <input type="radio"/> Disable
Extension Number	<input type="text" value="901"/>
Display Name	<input type="text" value="Phone"/>
Type	<input type="text" value="Phone"/> ▼
<input type="checkbox"/> Authentication	
Password	<input type="password" value="..."/>
E-mail Address	<input type="text"/>
Voice mail Password	<input type="password" value="..."/>
MWI	
<input type="radio"/> Notify User who Subscribed	<input checked="" type="radio"/> Force Notify User
Outgoing Call Use	
<input checked="" type="checkbox"/> SIP1	<input checked="" type="checkbox"/> SIP2
<input checked="" type="checkbox"/> SIP3	<input checked="" type="checkbox"/> SIP4
<input checked="" type="checkbox"/> SIP5	<input checked="" type="checkbox"/> SIP6
<input checked="" type="checkbox"/> ISDN2-TE	<input checked="" type="checkbox"/> PSTN
Answer Mode	
No answer after	<input type="text" value="60"/> sec then <input type="text" value="Keep Ring"/> ▼
Busy then	<input type="text" value="Do Nothing"/> ▼
Not on-line	<input type="text" value="Do Nothing"/> ▼

Send a test e-mail

OK Cancel

5.12.2 Line Setting

There are six SIP outside lines and one ISDN line provided by this IP PBX device. Users can set them respectively from SIP Trunk and ISDN Trunk.

[IP PBX >> Line Setting](#)

[Line Setting](#)

SIP Trunk ISDN Trunk PSTN Trunk

DID (Direct Inward Dialing) is a service provided by SIP providers. It allows one main SIP account (**SIP Trunk**) attached with several sub-accounts (defined in **Alias List** under **SIP Trunk**). When the main accounts have been registered on VigorIPPBX 2820, it means the router owns these sub-accounts at the same time. That is, people can dial main SIP accounts or sub-accounts via VigorIPPBX 2820.

5.12.2.1 SIP Trunk

This page allows you to set profiles for 6 SIP outside lines (main account) at one time with 50 alias names (sub account).

[IP PBX >> SIP Trunk List](#)

SIP Trunk List Refresh Seconds: | [Refresh](#) |

Index	Profile Name	Domain/Realm	Proxy	Account Number/Name	Trunk Number	Status
1.					001	-
2.					002	-
3.					003	-
4.					004	-
5.					005	-
6.					006	-

R:Success registered on SIP server
 -:Fail to register on SIP server

[Alias List](#)

Profile Name	Display the name for such main account.
Domain/Realm	Display domain name or IP address of the SIP Registrar server.
Proxy	Display the domain name or IP address of SIP proxy server.
Account Number/Name	Display the account name of SIP Address.
Trunk Number	Display the short number for such account.
Status	Display current status for the account (successful registration or failed registration).
Alias List	Allows you to set sub accounts for the main accounts in SIP Trunk.

Please click any number under Index to set detailed configuration.

SIP Trunk Index 1

Profile Name	<input type="text"/> (11 char max.)
Register via	Auto <input type="checkbox"/> Call without Registration
SIP Local Port	<input type="text" value="5070"/>
Domain/Reallm	<input type="text"/> (63 char max.)
Proxy	<input type="text"/> (63 char max.)
Proxy Port	<input type="text" value="5060"/>
Display Name	<input type="text"/> (23 char max.)
Account Number/Name	<input type="text"/> (63 char max.)
<input type="checkbox"/> Authentication ID	<input type="text"/> (63 char max.)
Password	<input type="text"/> (63 char max.)
Expiry Time	1 hour <input type="text" value="3600"/> sec
Trunk number	<input type="text" value="001"/> (3 char max.)
Out-going call CLI	<input checked="" type="radio"/> Main number <input type="radio"/> Alias number
Office hours answer mode	Auto Attendant
Non-Office hours answer mode	Auto Attendant

Note: SIP Local Port can not be equal to PBX Proxy Port.

OK Cancel

Profile Name

Assign a name for this profile for identifying. You can type similar name with the domain. For example, if the domain name is *draytel.org*, then you might set *draytel-1* in this field.

Register via

If you want to make VoIP call without register personal information, please choose **None** and check the box to achieve the goal. Some SIP server allows user to use VoIP function without registering. Choosing **Auto** is recommended. The system will select a proper way for your VoIP call.

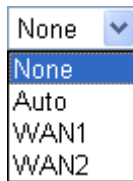

SIP Port

Set the port number for sending/receiving SIP message for building a session. The default value is **6060**. Your peer must set the same value in his/her Registrar.

Domain/Realm

Set the domain name or IP address of the SIP Registrar server.

Proxy

Set domain name or IP address of SIP proxy server. By the time you can type **:port number** after the domain name to specify that port as the destination of data transmission (e.g., **nat.draytel.org:5065**)

Proxy Port

Set port number for the proxy server.

Display Name

The caller-ID that you want to be displayed on your friend's screen.

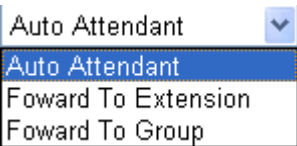
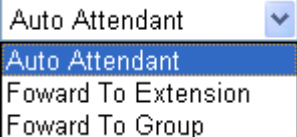
Account Number/Name	Enter your account name of SIP Address, e.g. every text before @..
Authentication ID	Check the box to invoke this function and enter the name or number used for SIP Authorization with SIP Registrar. If this setting value is the same as Account Name, it is not necessary for you to check the box and set any value in this field.
Password	The password provided to you when you registered with a SIP service.
Expiry Time	It is the time duration that your SIP Registrar server keeps your registration record. Before the time expires, the router will send another register request to SIP Registrar again.
Trunk Number	There are two ways to dial outside lines for an extension number. First, dial a short number and wait for a while. When dial tone appears, please dial the real outside line number. Second, dial a short number and then the real outside line number without waiting for dial tone. The short number is defined here as Trunk Number.
Out-going call CLI	<p>Determine which phone number will be shown to the remote end.</p> <p>Main number – Choose this item to display the SIP trunk number.</p> <p>Alias number – Choose this item to display the alias phone number, that is, the sub account.</p>
Office hours answer mode	<p>Set the answering mode for such outside line in office time. You can specify it with Auto Attendant (AA), or forward it to any Extension or Group directly.</p> 
Non-office hours answer mode	<p>Set the answering mode for such outside line in non-office time. You can specify it with Auto Attendant (AA), or forward it to any Extension or Group directly.</p> 

Alias List

Click the **Alias List** link to access into the configuration page as shown below.

[IP PBX >> Alias](#)

Alias List

Index	Profile Name	Number	Office Hours	Non Office Hours	Active	Trunk
1.			Auto Attendant	Auto Attendant	No	
2.			Auto Attendant	Auto Attendant	No	
3.			Auto Attendant	Auto Attendant	No	
4.			Auto Attendant	Auto Attendant	No	
5.			Auto Attendant	Auto Attendant	No	
6.			Auto Attendant	Auto Attendant	No	
7.			Auto Attendant	Auto Attendant	No	
8.			Auto Attendant	Auto Attendant	No	
9.			Auto Attendant	Auto Attendant	No	
10.			Auto Attendant	Auto Attendant	No	

<< [1-10](#) | [11-20](#) | [21-30](#) | [31-40](#) | [41-50](#) >>

[Next](#) >>

Profile Name	Display the alias name for such sub account.
Number	Display the phone number of such account.
Office Hours	Display the selected answer mode for office hours.
Non Office Hours	Display the selected answer mode for non office hours.
Active	Display current activation status for such account, enabled or disabled.
Trunk	Display the SIP Trunk for such sub account attached.

You can set 50 profiles as alias for SIP Trunk list. Click the number under Index to set detailed configuration.

[IP PBX >> Alias](#)

Alias 1.

Active	<input type="radio"/> Enable <input checked="" type="radio"/> Disable
Alias Name	<input type="text"/>
Alias Number	<input type="text"/>
Alias of SIP Trunk	1 - ??? <input type="button" value="v"/>
Out-going call CLI	<input checked="" type="radio"/> Main number <input type="radio"/> Alias number
Answer Mode	
Office hours answer mode	Auto Attendant <input type="button" value="v"/>
Non-Office hours answer mode	Auto Attendant <input type="button" value="v"/>

Active Click **Enable** to activate this entry. Or, click **Disable** to inactive this entry.

Alias Type a name for such account.

- Alias Number** Type a number for such account.
- Alias of SIP Trunk** Choose one of the items listed in SIP Trunk List for this alias profile.
- Out-going call CLI** Determine which phone number will be shown to the remote end.
 - Main number** – Choose this item to display the SIP trunk number.
 - Alias number** – Choose this item to display the alias phone number, that is, the sub account.
- Office hours answer mode** Set the answering mode for such outside line in office time. You can specify it with Auto Attendant (AA), or forward it to any Extension or Group directly.

- Non-office hours answer mode** Set the answering mode for such outside line in non-office time. You can specify it with Auto Attendant (AA), or forward it to any Extension or Group directly.

5.12.2.2 ISDN Trunk

This page allows you to set profile for ISDN outside line.

IP PBX >> ISDN Trunk

ISDN Trunk

ISDN 1 Trunk Number	<input type="text" value="903"/>
ISDN 2 Trunk Number	<input type="text" value="904"/>
Office hours answer mode	<input style="background-color: #e0e0e0; border: 1px solid #ccc; width: 100%;" type="button" value="Auto Attendant"/>
Non-Office hours answer mode	<input style="background-color: #e0e0e0; border: 1px solid #ccc; width: 100%;" type="button" value="Auto Attendant"/>
<input type="checkbox"/> ISDN Trunk Auto Hunt	<input type="text" value="666"/>

- ISDN 1 Trunk Number** Set the trunk number for extension to access when they want to make ISDN calls via this port.
- ISDN 2 Trunk Number** Set the trunk number for extensions to access when they want to make ISDN calls via this port.

Note: When this field grayed out and can not set the number, it means the port is set as ISDN-S0 type. Therefore, it can not be used as ISDN Trunk port. If you want to use this port as ISDN Trunk, please go to

IPPBX>PBX System> Phone Setting page to change the port type.

Office hours answer mode

Set the answering mode for such outside line in office time. You can specify it with Auto Attendant (AA), or forward it to any Extension or Group directly.

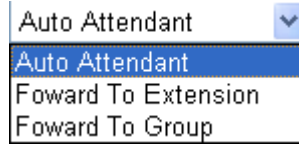

Non-office hours answer mode

Set the answering mode for such outside line in non-office time. You can specify it with Auto Attendant, or forward it to any Extension or Group directly.

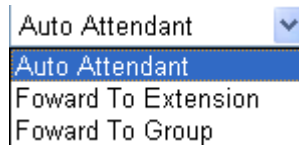

ISDN Trunk Auto Hunt

When both ISDN ports set to TE mode, you can specify an auto hunt number. When people want to dialing to I SDN network via this number by using extension, the router will auto hunt an available line for it.

5.12.2.3 PSTN Trunk

This page allows you to set profile for PSTN line.

[IP PBX >> PSTN Trunk](#)

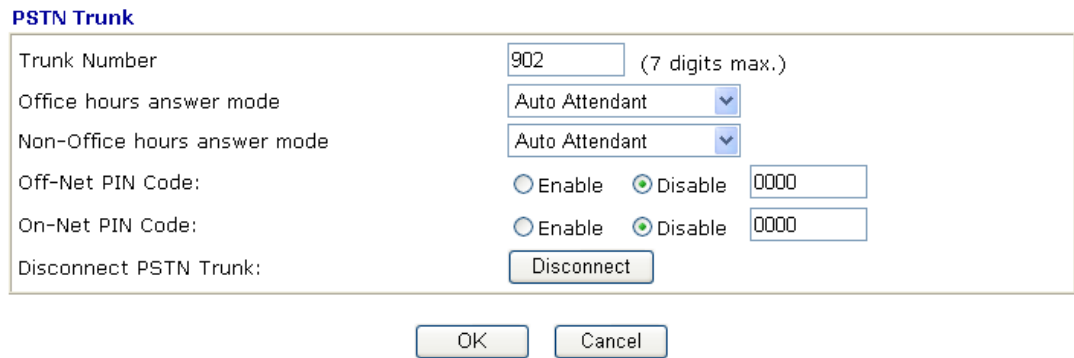

Trunk Number

Type the PSTN Trunk number in this field. When an extension wants to access the PSTN trunk, it needs to dial the trunk number, just like you dial 0 to access trunk line in normal PBX system.

Office hours answer mode

Set the answering mode for such outside line in office time. You can specify it with Auto Attendant (AA), or forward it to any Extension or Group directly.

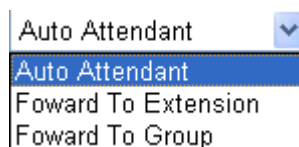

Non-office hours answer mode

Set the answering mode for such outside line in non-office time. You can specify it with Auto Attendant, or forward it to any Extension or Group directly.

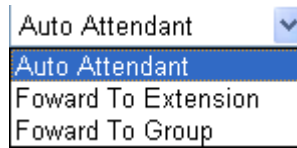

Off-Net Pin Code

If a user needs to do off-net (from VoIP to PSTN) call, he has to input the PIN code number to do the authentication for checking if the call is off-net or not. Select **Enable** and type the number as a Pin Code.

On-Net PIN Code

If a user needs to do on-net (from PSTN to VoIP) call, he has to input the PIN code number to do the authentication for checking if the call is on-net or not. Select **Enable** and type the number as a Pin Code.

Disconnect PSTN Trunk

Press this button to disconnect PSTN trunk when FXO seize the line and no way to release it.

5.12.3 Dial Plan

[IP PBX >> Dial Plan](#)

Dial Plan Configuration



5.12.3.1 Digit Map

For the convenience of user, this page allows users to edit prefix number for the SIP account with adding number, stripping number or replacing number. It is used to help user having a quick and easy way to dial out through VoIP interface.

[IP PBX >> DialPlan Setup](#)

Digit Map Setup

#	Enable	Match Prefix	Mode	OP Number	Min Len	Max Len	Route	Backup Route
1	<input checked="" type="checkbox"/>	886	Replace	86	0	0	ISDN2-TE	None
2	<input checked="" type="checkbox"/>		None		0	0	ISDN2-TE	None
3	<input type="checkbox"/>		None		0	0	ISDN2-TE	None
4	<input type="checkbox"/>		Add		0	0	ISDN2-TE	None
5	<input type="checkbox"/>		Strip		0	0	ISDN2-TE	None
6	<input type="checkbox"/>		Replace		0	0	ISDN2-TE	None
7	<input type="checkbox"/>		None		0	0	ISDN2-TE	None

18	<input type="checkbox"/>		None		0	0	ISDN2-TE	None
19	<input type="checkbox"/>		None		0	0	ISDN2-TE	None
20	<input type="checkbox"/>		None		0	0	ISDN2-TE	None

- Note:**
1. The length for Min Len and Max Len fields should be between 0~25.
 2. Wildcard '?' is supported.

Tips for One stage dialing for trunk line:

1. Set the mode to "Strip".
2. Let the OP number and Prefix number be the same.
3. Set a suitable range for the length fields.
4. Select a specific route for this rule.

For example, set op number and prefix number to 1, and set the route to VoIP1. When an extension dial "12345", PBX will dial "2345" to the route of VoIP1.

5. Backup route will trigger when default route not registered or receive fail response.

OK Cancel

Enable

Check this box to invoke this setting.

Match Prefix

It is used to match with the number you dialed and can be modified with the **OP Number** by the mode (add, strip or replace).

Mode

None - No action.

Add - When you choose this mode, the OP number will be added before the prefix number for calling out through the specific route.

Strip - When you choose this mode, partial or the whole prefix number will be deleted according to the OP number. Take the above picture (Prefix Table Setup web page) as an example, the OP number of 886 will be deleted completely for the prefix number is set with 886.

Replace - When you choose this mode, the OP number will be replaced by the prefix number for calling out through the specific VoIP interface. Take the above picture (Prefix Table Setup web page) as an example, the prefix number of 03 will be replaced by 8863. For example: dial number of "031111111" will be changed to "8863111111" and sent to SIP server.

Mode

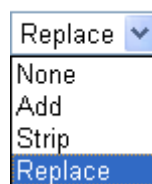

OP Number

The front number you type here is the first part of the account number that you want to execute special function (according to the chosen mode) by using the prefix number.

Min Len

Set the minimal length of the dial number for applying the prefix number settings. Take the above picture (Prefix Table Setup web page) as an example, if the dial number is between 7 and 9, that number can apply the prefix number settings here.

Max Len

Set the maximum length of the dial number for applying the

prefix number settings.

Route

Choose the one that you want to enable the match prefix settings from the saved SIP accounts. Please set up one SIP account first to make this route available. This item will be changed according to the port settings configured in **IP PBX>>PBX System>>Phone Settings** and **IP PBX>>Line Settings>>SIP Trunk**.

IP PBX >> PBX System

Phone List

Index	Port	Call Feature	Codec	T
1	Phone	CW,CT,	G.729A/B	U De
2	ISDN1-S0		G.729A/B	U De
3	ISDN2-TE		G.729A/B	U De

Refresh Seconds: 5 | Refresh |

Account Number/Name	Trunk Number	Status
	001	-
	002	-
	003	-
	004	-
	005	-
	006	-

Backup Route

It will be triggered when the original route is not registered or receives failed response.

Backup Route

None

None

ISDN2-TE

VoIP1

VoIP2

VoIP3

VoIP4

VoIP5

VoIP6

None

5.12.3.2 Phone Book

In this section, you can set your VoIP contacts in the “phonebook”. It can help you to make calls quickly and easily by using **Speed Dial Number**. There are total 20 index entries in the phonebook for you to store all your friends and family members’ phone numbers.

Phone Book Setup

#	Enable	Speed Dial Number	Phone Number	Route
1	<input checked="" type="checkbox"/>	<input type="text"/>	<input type="text"/>	VoIP1
2	<input type="checkbox"/>	<input type="text"/>	<input type="text"/>	VoIP1
3	<input type="checkbox"/>	<input type="text"/>	<input type="text"/>	VoIP2
4	<input type="checkbox"/>	<input type="text"/>	<input type="text"/>	VoIP3
5	<input type="checkbox"/>	<input type="text"/>	<input type="text"/>	VoIP4
6	<input type="checkbox"/>	<input type="text"/>	<input type="text"/>	VoIP5
7	<input type="checkbox"/>	<input type="text"/>	<input type="text"/>	VoIP6
17	<input type="checkbox"/>	<input type="text"/>	<input type="text"/>	VoIP1
18	<input type="checkbox"/>	<input type="text"/>	<input type="text"/>	VoIP1
19	<input type="checkbox"/>	<input type="text"/>	<input type="text"/>	VoIP1
20	<input type="checkbox"/>	<input type="text"/>	<input type="text"/>	VoIP1

- Enable** Check the box to enable the entry.
- Speed Dial Number** Type the digit number (maximum 6) in this field which can dial to the client with the phone number specified later.
- Phone Number** Type the complete phone number (maximum 19) for the client that you want to dial out.
- Route** Choose the interface (from VoIP 1 to VoIP 6) for the phone call to dial out.

5.12.3.3 Call Barring

Call barring is used to block phone calls coming from the one that is not welcomed.

Call Barring Setup [Set to Factory Default](#)

Index	Call Direction	Barring Type	Barring Number/URL/URI	Route	Schedule	Status
1.						x
2.						x
3.						x
4.						x
5.						x
6.						x
7.						x
8.						x
9.						x
10.						x

<< [1-10](#) | [11-20](#) >> [Next](#) >>

- Advanced:**
- [Block Anonymous](#)
 - [Block Unknown Domain](#)

Click any index number to display the dial plan setup page.

Call Barring Index No. 1

<input checked="" type="checkbox"/> Enable	
Call Direction	IN
Apply To	All
Barring Type	Specific URI/URL
Specific URI/URL	
Interface	1-???
Index(1-15) in Schedule Setup	

OK Cancel

Enable

Click this to enable this entry.

Call Direction

Determine the direction for the phone call, IN – incoming call, OUT-outgoing call, IN & OUT – both incoming and outgoing calls.

IN

- IN
- OUT
- IN & OUT

Apply To

Call barring can be applied to specific extension number (set in **IP PBX >>Extension**) or group (**IP PBX>>PBX System>>Hunt Group**) respectively or applied to all of extensions/groups completely.

Extension 1 - --- Extension

Specific URI/URL

Group 1 - ??? Group

Specific URI/URL

Barring Type

Determine the type of the VoIP phone call, URI/URL or number. It will bring out different setting options.

Specific URI/URL

- Specific URI/URL
- Specific Number

Specific Number/Specific URI/URL

This field will be changed based on the type you selected for barring Type. Please type numbers or URI/URL

Interface

“All” means all the phone calls (including ISDN1/2 & SIP) will be blocked with such mechanism. Or you can specify certain port (set in **IP PBX>>Line Setting>> SIP Trunk**) to be blocked by choosing from the drop down list.

Index (1-15) in Schedule

Enter the index of schedule profiles to control the call barring according to the preconfigured schedules. Refer to section **Application >>Schedule** for detailed

configuration.

Additionally, you can set advanced settings for call barring such as **Block Anonymous** or **Block Unknown Domain**. Simply click the relational links to open the web page.

For **Block Anonymous** – this function can block the incoming calls without caller ID on the interface specified in the following window. Such controlling also can be done based on preconfigured schedules.

[IP PBX >> DialPlan Setup](#)

Call Barring Block Anonymous

Enable
Index(1-15) in [Schedule](#) Setup , , ,

Note:Block the incoming calls which do not have the caller ID.

For **Block Unknown Domain** – this function can block incoming calls from unrecognized domain that is not specified in SIP accounts. Such controlling also can be done based on preconfigured schedules.

[IP PBX >> DialPlan Setup](#)

Call Barring Block Unknown Domain

Enable
Index(1-15) in [Schedule](#) Setup , , ,

Note:If the domain of the incoming call is different from the domain found in SIP accounts, the call should be blocked.

5.12.4 PBX System

This page allows you to set relational (advanced) settings for PBX

[IP PBX >> PBX System](#)

PBX System

[SIP Proxy Setting](#)
[Hunt Group](#)
[Voice Mail Configuration](#)
[Office Hours](#)
[Auto Attendant Wizard](#)
[Prompt Maintenance](#)
[Phone Setting](#)
[SIP Trunk and Extension Configuration Backup](#)

5.12.4.1 SIP Proxy Setting

To make the IP phone to be registered in IP PBX device successfully, it is necessary for the users to configure settings in this page.

SIP Proxy Setting

SIP Local Port	5060
SIP Proxy Realm	PBX.com
Parking Server Number	777
Call Pickup Number	*1
RTP Local Port Start	15050
RTP Local Port End	20000

Note: The Call Pickup Number used for both specific number pickup and group pickup.

OK Cancel

SIP Local Port

Set a port number as SIP local port. The default setting is 5060.

SIP Proxy Realm

Type SIP service domain name. In full SIP URI, such is the part after @ symbol.

Parking Server Number

This number is used to communicate with the parking server and invoke the parking function. The default setting number is "777".

1. When you receive a phone call and need to go to the remote end to talk with the same caller, you have to hold the phone call and transfer the call to this number from VoIP phone set.
2. The parking sever will give you another voice number (e.g., your parking number is XXXX).
Please remember it and hang up the phone set.
3. Next, use another phone set in remote end to communicate with that caller again by dialing the voice number (XXXX).

Call Pickup Number

Press the number specified here to pickup a call which is ringing on another extension. For specific extension pickup, press 'pickup number' + 'extension number' + #; for group pickup, just press 'pickup number' + #.

For example, pickup number is *1 and 101 ~ 105 are set in the same hunt group. When an incoming call rings extension 101; the extension 102~105 can just dial *1# to pickup the call. However, if the extension 106 wants to pickup that call, it needs to dial *1101#.

**RTP Local Port Start/
RTP Local Port End**

If your VoIP service provider gave you such information, please type the port number for RTP traffic. Otherwise, keep the default setting. For one port number used, type the same port number in RTP Local Port Start and RTP Local Port End fields. To set a range for port numbers type different port numbers in RTP Local Port Start and RTP Local Port End fields.

5.12.4.2 Hunt Group

This page allows you to make several extension numbers under certain group. Thus, when a phone call incomes, all the extension numbers under such group will ring.

[IP PBX >> PBX System](#)

Hunt Group

Index	Group Name	Group Extension	Hunt List (Max 20 Extension)
1.			
2.			
3.			
4.			
5.			
6.			
7.			
8.			
9.			
10.			

- Index** You can set 10 groups for using in different conditions. Simply click the number under Index to specify detailed information.
- Group Name** Display the name of such group.
- Group Extension** Display the extension number of such group.
- Hunt List** Display the members inside the group.

Click any index number to display the hunt group setup page.

Hunt Groups Index 1

Hunt Group Name

Hunt Group Extension

Hunt Rule

Timeout Seconds (MUST greater than 10 seconds)

Overflow Rule

Hunt List (Maximum Of Group Member:20)

Available		Chosen
32 - ---	Add >>	
33 - ---		
34 - ---		
35 - ---		
36 - ---		
37 - ---		
38 - ---	Add All	
39 - ---	Remove <<	
40 - ---	Remove All	
41 - ---	Move Up	
42 - ---	Move Down	
43 - ---		
44 - ---		
45 - ---		
46 - ---		
47 - ---		
48 - ---		
49 - 903		
50 - 901		

OK Cancel

- Hunt Group Name** Type suitable name for such group.
- Hunt Group Extension** Type extension number for such group.
- Hunt Rule** Use the drop down menu to choose rule for such group.
Simultaneously – Choose such rule can make all the phones in the groups ring while receiving incoming calls.
Sequentially - Choose such rule can make all the phones in the groups ring one by one while receiving incoming calls.
- Timeout** Set the timeout for such group. The default setting is 60 seconds. After timeout, the system will execute overflow rule selected below.
- Overflow Rule** When the hunt group does not have any response to an incoming call, the call will be processed with the way chosen here such as being terminated, keeping ringing, forwarding to certain group, forwarding to certain extension or leaving voice mail and so one. If you choose Forward to Group or Forward to Extension, a drop down box will appear for you to choose the extension / group to transfer to.

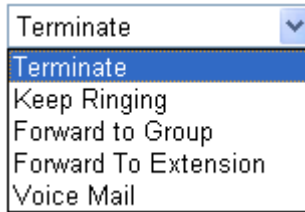

- Add>>** Click this button to move the selected item in Available area to Chosen area.
- Add All** Click this button to move all of the items in Available area to Chosen area.
- Remove<<** Click this button to move the selected item in Chosen area to Available area.
- Remove All** Click this button to clear all of the selections in Chosen area.
- Move Up** Click this button to move the selected item to the upper place.
- Move Down** Click this button to move the selected item to the lower place.

5.12.4.3 Voice Mail Configuration

This page allows users to set actions for voices mails.

[IP PBX >> PBX System](#)

Voice Mail Configuration

Extension for checking messages	<input type="text" value="888"/>	(20 ~ 65535)
<input type="checkbox"/> Send Voice Message by Email		
<input type="checkbox"/> Delete Voice Message after Sending Mail		
Day for keeping voice mail	<input type="text" value="3"/>	(1~7)
Maximum messages time	<input type="text" value="30 Sec"/>	
Mail Voice-Mail Setup		
SMTP Server	<input type="text"/>	
SMTP Port	<input type="text" value="25"/>	
<input type="checkbox"/> Authentication		
User Name	<input type="text"/>	
Password	<input type="text"/>	

Extension for checking messages

The number specified here is used for the user to listen personal voice mail from IP PBX device.

Send Voice Message by Email

IP PBX can send the voice mail to the specified e-mail address for the incoming call if you check this box.

Delete Voice Message after Sending Mail - IP PBX can send the voice mail to the specified e-mail address for the incoming call directly and delete the temporary file in IP PBX if you check this box.

Days for keeping voice mail

Type the days for keeping each voice mail.

Maximum message time

Type the recording length for each voice mail.

SMTP Server

Type IP address or domain name for the server specified for receiving voice messages.

SMTP Port

Type the port number for the server. The default value is 25.

Authentication

Check this box to authenticate the mail server.

User Name

Type a name for IP PBX to authenticate the mail server automatically while connecting.

Password

Type a password for IP PBX to authenticate the mail server automatically while connecting.

5.12.4.4 Office Hours

You can set ten groups of office hours including starting point, ending point on duty day(s).

[IP PBX >> PBX System](#)

Office Hours

Index	Enable	Office Hour Start (HHMM)		Office Hour End (HHMM)		Weekdays
1	<input checked="" type="checkbox"/>	02	25	04	25	<input checked="" type="checkbox"/> Sun <input type="checkbox"/> Mon <input type="checkbox"/> Tue <input checked="" type="checkbox"/> Wed <input type="checkbox"/> Thu <input type="checkbox"/> Fri <input type="checkbox"/> Sat
2	<input type="checkbox"/>	00	00	00	00	<input type="checkbox"/> Sun <input type="checkbox"/> Mon <input type="checkbox"/> Tue <input type="checkbox"/> Wed <input type="checkbox"/> Thu <input type="checkbox"/> Fri <input type="checkbox"/> Sat
3	<input type="checkbox"/>	00	00	00	00	<input type="checkbox"/> Sun <input type="checkbox"/> Mon <input type="checkbox"/> Tue <input type="checkbox"/> Wed <input type="checkbox"/> Thu <input type="checkbox"/> Fri <input type="checkbox"/> Sat
4	<input type="checkbox"/>	00	00	00	00	<input type="checkbox"/> Sun <input type="checkbox"/> Mon <input type="checkbox"/> Tue <input type="checkbox"/> Wed <input type="checkbox"/> Thu <input type="checkbox"/> Fri <input type="checkbox"/> Sat
5	<input type="checkbox"/>	00	00	00	00	<input type="checkbox"/> Sun <input type="checkbox"/> Mon <input type="checkbox"/> Tue <input type="checkbox"/> Wed <input type="checkbox"/> Thu <input type="checkbox"/> Fri <input type="checkbox"/> Sat
6	<input type="checkbox"/>	00	00	00	00	<input type="checkbox"/> Sun <input type="checkbox"/> Mon <input type="checkbox"/> Tue <input type="checkbox"/> Wed <input type="checkbox"/> Thu <input type="checkbox"/> Fri <input type="checkbox"/> Sat
7	<input type="checkbox"/>	00	00	00	00	<input type="checkbox"/> Sun <input type="checkbox"/> Mon <input type="checkbox"/> Tue <input type="checkbox"/> Wed <input type="checkbox"/> Thu <input type="checkbox"/> Fri <input type="checkbox"/> Sat
8	<input type="checkbox"/>	00	00	00	00	<input type="checkbox"/> Sun <input type="checkbox"/> Mon <input type="checkbox"/> Tue <input type="checkbox"/> Wed <input type="checkbox"/> Thu <input type="checkbox"/> Fri <input type="checkbox"/> Sat
9	<input type="checkbox"/>	00	00	00	00	<input type="checkbox"/> Sun <input type="checkbox"/> Mon <input type="checkbox"/> Tue <input type="checkbox"/> Wed <input type="checkbox"/> Thu <input type="checkbox"/> Fri <input type="checkbox"/> Sat
10	<input type="checkbox"/>	00	00	00	00	<input type="checkbox"/> Sun <input type="checkbox"/> Mon <input type="checkbox"/> Tue <input type="checkbox"/> Wed <input type="checkbox"/> Thu <input type="checkbox"/> Fri <input type="checkbox"/> Sat

Holiday Setting

Month	Date
1	<input type="text"/>
2	<input type="text"/>
3	<input type="text"/>
4	<input type="text"/>
5	<input type="text"/>
6	<input type="text"/>
7	<input type="text"/>
8	<input type="text"/>
9	<input type="text"/>
10	<input type="text"/>
11	<input type="text"/>
12	<input type="text"/>

Office Hour Start

Use the drop down menu to choose the time as the starting point.

Office Hour End

Use the drop down menu to choose the time as the ending point.

Weekdays

Check the day(s) to apply the office hour for that index.

Date

Specify date(s) for applying the office hour settings in holiday, for example, type 2,4 6 & 7 in the field of Date for Month 1. It means January 2,4,6 & 7 will apply the office hour settings configured in this page.

5.12.4.5 Auto Attendant Wizard

The first page is configured for phone calls in office hours.

[IP PBX >> PBX System](#)

Auto Attendant Wizard - Office Hours

Key	Action
0	Ring Extension 1 - ---
1	Ring Extension 1 - ---
2	Ring Extension 1 - ---
3	Ring Extension 1 - ---
4	Ring Extension 1 - ---
5	Ring Extension 1 - ---
6	Ring Extension 1 - ---
7	Ring Extension 1 - ---
8	Ring Extension 1 - ---
9	Ring Extension 1 - ---

Click **Next**. The second page is configured for phone calls in non-office hours.

[IP PBX >> PBX System](#)

Auto Attendant Wizard - Non-Office Hours

Key	Action
0	Ring Extension 1 - ---
1	Ring Extension 1 - ---
2	Ring Extension 1 - ---
3	Ring Extension 1 - ---
4	Ring Extension 1 - ---
5	Ring Extension 1 - ---
6	Ring Extension 1 - ---
7	Ring Extension 1 - ---
8	Ring Extension 1 - ---
9	Ring Extension 1 - ---

Key 0-9

Key 0 is fixed with Ring Extension.

Key 1 – 9 can be set with different actions.

Action

Drop down menu 1 contains Ring Extension /Plays

Prompt/Ring Hunt Group/Not Used.

The screenshot shows a configuration window with a dropdown menu titled "Action". The menu is open, showing four options: "Ring Extension", "Plays Prompt", "Ring Hunt Group", and "Not Used". The "Ring Extension" option is highlighted in blue. To the right of the menu, there are three input fields, each with a dropdown arrow and the value "1 - ---".

Ring Extension - Only the extension number selected here will ring.

Plays Prompt - Audio file will be played automatically.

Ring Hunt Group – Only the extension number within the Hunt Group will ring.

Not Used – Nothing will be done for the key.

Drop down menu 2 contains extension name (ex. Tom, Mike) or prompt [Prompt 1~ Prompt 10, audio files] or Hunt Group Name [(ex. Sales, RD2)]. It will be changed according to drop down menu 1.

The screenshot shows a configuration window with four rows of dropdown menus. The first row is "Ring Extension" with a value of "1 - ---". The second row is "Plays Prompt" with a value of "Prompt 1". The third row is "Ring Hunt Group" with a value of "1 - ???". The fourth row is "Not Used".

Finally, the following window will appear.

IP PBX >> PBX System

Auto Attendant Wizard - Record Prompts

Please enter **** and (1151#~1160#:Record user ivr data;1251#~1260#:Play user ivr data.) to access IVR and auto-attendant message menu.

To record user prompts:

Step 1: Connect an analog phone to the phone port.

Step 2: Enter****to access the IVR menu.

Step 3: Enter 11XX# to record a prompt.

[Here "XX" can be from 51 to 60 for recording user prompt 1 to user prompt 10 respectively.]

You can record the office hours and non-office hour greetings or other prompts.

Prompt 5 is used as office hours greeting.

Prompt 6 is used as non-office hours greeting.

< Back OK Cancel

5.12.4.6 Prompt Maintenance

The IP PBX system provides several audio files for users to choose for playing. Moreover, users can upload other audio files from USB storage or hard disk or others to make the IP

PBX system playing. Users can record audio files and upload to router or download to PC. However, the file format of the audio file must follow the rule stated on the web page. Users can record the audio files through a phone set connected to the router or use audio record program on PC.

IP PBX >> PBX System

Prompt Maintenance

Download

Prompt G711 01

Upload

Note: The file name follows a pre-defined rule:
 System Prompt File: v2820pbx_sysprompt.ivr ;
 User Prompt File: v2820pbx_g711_userpromptXX.wav; XX: 01~10 ;
 If g711 Prompt File is upload, we will generate related G729 Prompt File automatically. But we can not generate G711 Prompt file based on G729 Prompt file;

Supported wav file format, the length of time is 75 sec at most.

Codec	Channels	Sample rate	Bits
Linear PCM	Stereo, Mono	8k, 11.025k, 12k, 16k, 22.05k, 24k, 32k, 44.1k, 48k	16
A-law g711	Stereo, Mono	8k, 11.025k, 12k, 16k, 22.05k, 24k, 32k, 44.1k, 48k	8
u-law g711	Stereo, Mono	8k, 11.025k, 12k, 16k, 22.05k, 24k, 32k, 44.1k, 48k	8

Download

The audio file can be saved with IVR file format or WAV file format. In general, it will be saved in the router's memory after you record it. To back up the audio file(s) (saved in FLASH of the router) to your computer, please choose the one you want from the drop-down menu and click **Back Up**.

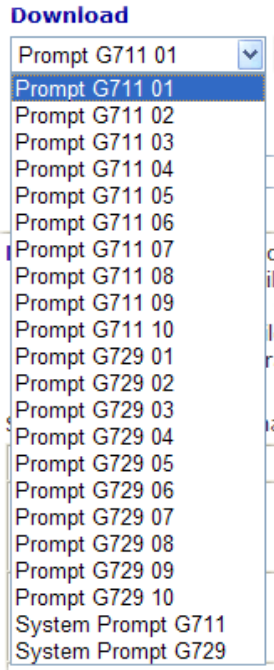

Prompt 1 to prompt 10 will be used for user-defined audio files (file format must be .WAV). System Prompt file is provided by router firmware.

Upload

System Prompt file is provided by router firmware. To use such audio file, you have to upload it to flash memory of the router after finishing firmware update.

Click this **Browse** button to browse and choose other audio files.

Restore

Click this button to save the file to the router. Next time, the audio file will be played in IP PBX system.

Record audio file

Below shows a flow chart for using a phone set to record audio file.

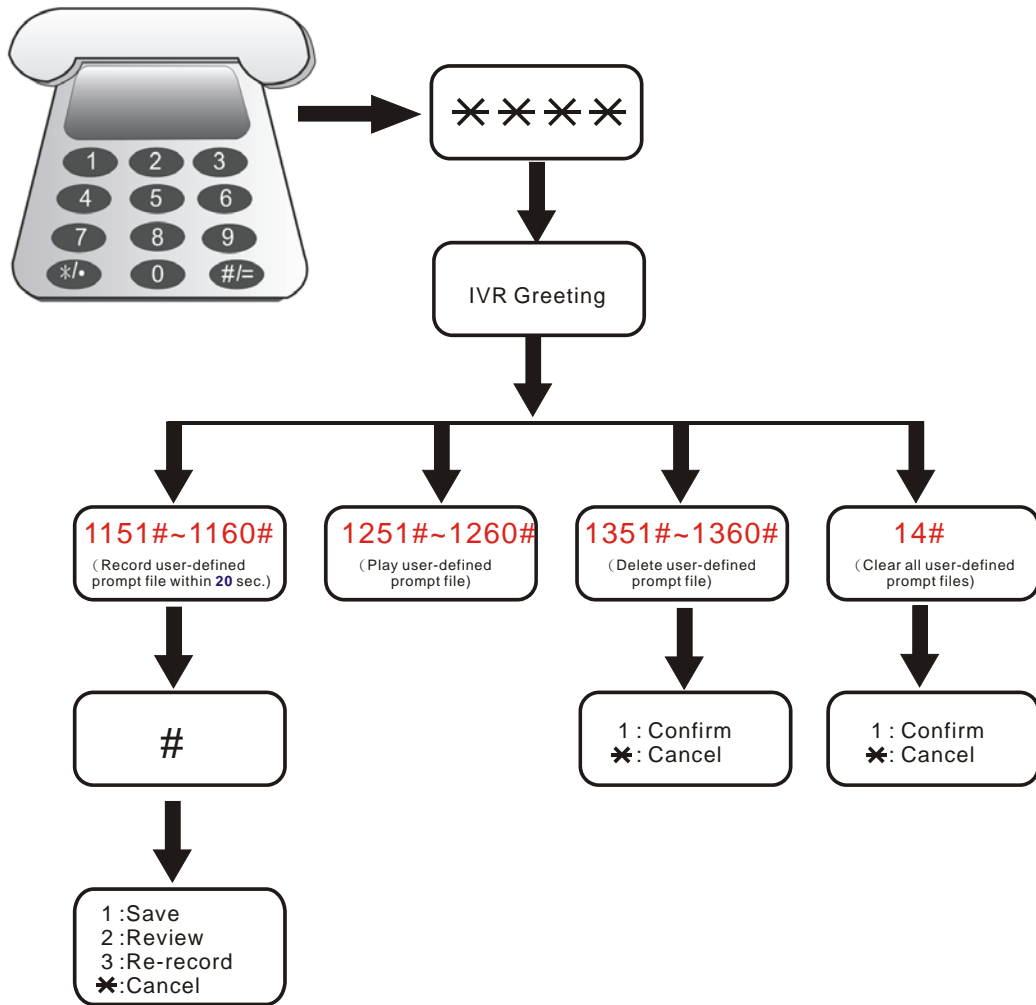

5.12.4.7 Phone Setting

This page allows user to set phone settings.

[IP PBX >> PBX System](#)

Phone List Refresh Seconds:

Index	Port	Call Feature	Codec	Tone	Gain (Mic/Speaker)	Extension Number	DTMF Relay
1	Phone	CW,CT,	G.729A/B	User Defined	5/5	901	OutBand
2	<input type="text" value="ISDN1-S0"/>		G.729A/B	User Defined	5/5	903	OutBand
3	<input type="text" value="ISDN2-TE"/>		G.729A/B	User Defined	5/5	904	OutBand
4	FXO		G.729A/B	User Defined	5/5	902	OutBand

RTP

Symmetric RTP

Dynamic RTP Port Start

Dynamic RTP Port End

RTP TOS

VoIP Collection Timer sec

VoIP Collection Timer Length

Phone List

Port – There are four phone ports provided here for you to configure. Index 1 and Index 4 are fixed and two (Index 2 & 3) are configurable. **Phone** port allows you to set general settings for analog phones. **FXO** port allows you to configure settings for PBX line. **ISDN** port allows you to set common settings for ISDN network connection. ISDN1 and ISDN2 port are configurable. Please use the drop down list to choose **ISDN1/2-TE** for Internet connection or choose **ISDN1/2-S0** (ISDN intern) for ISDN phone. In addition, you can connect six phones to this router in certain case. Please refer to **Section 1-4** for detailed information of ISDN phone/network connection.

Call Feature – A brief description for call feature will be shown in this field for your reference.

Codec – The default Codec setting for each port will be shown in this field for your reference. You can click the number below the Index field to change it for each phone port.

Tone - Display the tone settings that configured in the advanced settings page of Phone Index.

Gain - Display the volume gain settings for Mic/Speaker that configured in the advanced settings page of Phone Index.

Default SIP Account – “draytel_1” is the default SIP account. You can click the number below the Index field

to change SIP account for each phone port.

DTMF Relay – Display DTMF mode that configured in the advanced settings page of Phone Index.

RTP

Symmetric RTP – Check this box to invoke the function. To make the data transmission going through on both ends of local router and remote router not misleading due to IP lost (for example, sending data from the public IP of remote router to the private IP of local router), you can check this box to solve this problem.

Dynamic RTP Port Start - Specifies the start port for RTP stream. The default value is 10050.

Dynamic RTP Port End - Specifies the end port for RTP stream. The default value is 15000.

RTP TOS – It decides the level of VoIP package. Use the drop down list to choose any one of them.

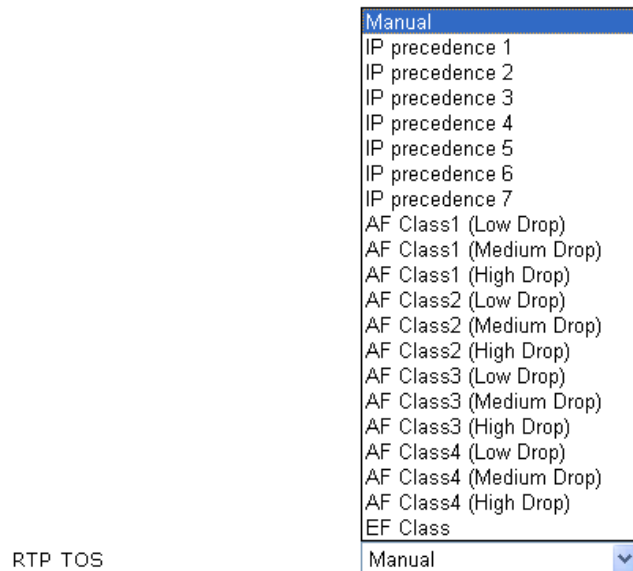

VoIP Collection Timer – Not available.

VoIP Collection Timer Length - Not available.

Detailed Settings for Phone Port

Click the number link of Phone port, you can access into the following page for configuring Phone settings. Below is the sample page for Phone port.

[IP PBX >> PBX System](#)

Phone

<p>Call Feature</p> <p><input type="checkbox"/> Hotline <input type="text"/></p> <p><input type="checkbox"/> Session Timer <input type="text" value="90"/> sec</p> <p><input type="checkbox"/> DND(Do Not Disturb) Mode Index(1-15) in Schedule Setup: <input type="text"/>, <input type="text"/>, <input type="text"/>, <input type="text"/></p> <p>Note: Action and Idle Timeout settings will be ignored.</p> <p><input type="checkbox"/> CLIR (hide caller ID)</p> <p><input checked="" type="checkbox"/> Call Waiting</p> <p><input checked="" type="checkbox"/> Call Transfer</p>	<p>Codecs</p> <p>Prefer Codec <input type="text" value="G.729A/B (8Kbps)"/> ▼</p> <p><input type="checkbox"/> Single Codec</p> <p>Packet Size <input type="text" value="20ms"/> ▼</p> <p>Voice Active Detector <input type="text" value="Off"/> ▼</p>
---	--

OK Cancel Advanced

Hotline

Check the box to enable it. Type in the SIP URL in the field for dialing automatically when you pick up the phone set.

Session Timer

Check the box to enable the function. In the limited time that you set in this field, if there is no response, the connecting call will be closed automatically.

DND (Do Not Disturb) Mode

Set a period of peace time without disturbing by VoIP phone call. During the period, the one who dial in will listen busy tone, yet the local user will not listen any ring tone.

Index (1-15) in Schedule - Enter the index of schedule profiles to control the DND mode according to the preconfigured schedules. Refer to section **Applications>> Schedule** for detailed configuration.

CLIR (hide caller ID)

Check this box to hide the caller ID on the display panel of the phone set.

Call Waiting

Check this box to invoke this function. A notice sound will appear to tell the user new phone call is waiting for your response. Click hook flash to pick up the waiting phone call.

Call Transfer

Check this box to invoke this function. Click hook flash to initiate another phone call. When the phone call connection succeeds, hang up the phone. The other two sides can communicate, then.

Codecs

Prefer Codec - Select one of five codecs as the default for your VoIP calls. The codec used for each call will be negotiated with the peer party before each session, and so may not be your default choice. The default codec is G.729A/B; it occupies little bandwidth while maintaining

good voice quality.

If the upstream speed is only 64Kbps, do not use G.711 codec. It is better for you to have at least 256Kbps upstream if you would like to use G.711.

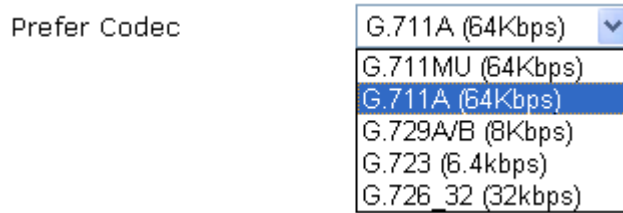

Single Codec – If the box is checked, only the selected Codec will be applied.

Packet Size - The amount of data contained in a single packet. The default value is 20 ms, which means the data packet will contain 20 ms voice information.



Voice Active Detector - This function can detect if the voice on both sides is active or not. If not, the router will do something to save the bandwidth for other using. Click On to invoke this function; click off to close the function.

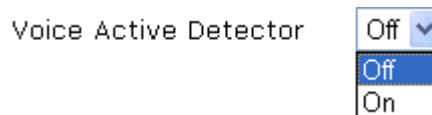

In addition, you can press the **Advanced** button to configure tone settings, volume gain, MISC and DTMF mode. **Advanced** setting is provided for fitting the telecommunication custom for the local area of the router installed. Wrong tone settings might cause inconvenience for users. To set the sound pattern of the phone set, simply choose a proper region to let the system find out the preset tone settings and caller ID type automatically. Or you can adjust tone settings manually if you choose User Defined. TOn1, TOff1, TOn2 and TOff2 mean the cadence of the tone pattern. TOn1 and TOn2 represent sound-on; TOff1 and TOff2 represent the sound-off.

Advance Settings >> Phone1

Tone Settings

Region

	Low Freq (Hz)	High Freq (Hz)	T on 1 (msec)	T off 1 (msec)	T on 2 (msec)	T off 2 (msec)
Dial tone	<input type="text" value="350"/>	<input type="text" value="440"/>	<input type="text" value="0"/>	<input type="text" value="0"/>	<input type="text" value="0"/>	<input type="text" value="0"/>
Ringing tone	<input type="text" value="400"/>	<input type="text" value="450"/>	<input type="text" value="400"/>	<input type="text" value="200"/>	<input type="text" value="400"/>	<input type="text" value="2000"/>
Busy tone	<input type="text" value="400"/>	<input type="text" value="0"/>	<input type="text" value="375"/>	<input type="text" value="375"/>	<input type="text" value="0"/>	<input type="text" value="0"/>
Congestion tone	<input type="text" value="0"/>	<input type="text" value="0"/>	<input type="text" value="0"/>	<input type="text" value="0"/>	<input type="text" value="0"/>	<input type="text" value="0"/>

Volume Gain

Mic Gain(1-10)

Speaker Gain(1-10)

MISC

Dial Tone Power Level

Ring Frequency

DTMF

DTMF Mode

Payload Type(RFC2833)

Region

Select the proper region which you are located. The common settings of **Caller ID Type**, **Dial tone**, **Ringing tone**, **Busy tone** and **Congestion tone** will be shown automatically on the page. If you cannot find out a suitable one, please choose **User Defined** and fill out the corresponding values for dial tone, ringing tone, busy tone, congestion tone by yourself for VoIP phone.

Tone Settings

Region

- User Defined
- UK
- US
- Denmark
- Italy
- Germany
- Netherlands
- Portugal
- Sweden
- Australia
- Slovenia
- Czech
- Slovakia
- Hungary
- Switzerland
- France

Also, you can specify each field for your necessity. It is recommended for you to use the default settings for VoIP communication.

Volume Gain

Mic Gain (1-10)/Speaker Gain (1-10) - Adjust the volume of microphone and speaker by entering number

from 1- 10. The larger of the number, the louder the volume is.

MISC

Dial Tone Power Level - This setting is used to adjust the loudness of the dial tone. The smaller the number is, the louder the dial tone is. It is recommended for you to use the default setting.

Ring Frequency - This setting is used to drive the frequency of the ring tone. It is recommended for you to use the default setting.

DTMF

DTMF Mode – There are four DTMF modes for you to choose.

InBand - Choose this one then the Vigor will send the DTMF tone as audio directly when you press the keypad on the phone

OutBand - Choose this one then the Vigor will capture the keypad number you pressed and transform it to digital form then send to the other side; the receiver will generate the tone according to the digital form it receive. This function is very useful when the network traffic congestion occurs and it still can remain the accuracy of DTMF tone.

SIP INFO- Choose this one then the Vigor will capture the DTMF tone and transfer it into SIP form. Then it will be sent to the remote end with SIP message.

DTMF mode

InBand	▼
InBand	
OutBand (RFC2833)	
SIP INFO (cisco format)	
SIP INFO (nortel format)	

Payload Type (rfc2833) - Choose a number from 96 to 127, the default value was 101. This setting is available for the OutBand (RFC2833) mode.

Detailed Settings for ISDN1/2-S0 Port

Click the number link of Index 2 or Index 3 (ISDN1-S0 or ISDN2-S0), you can access into the following page for configuring Phone settings.

IP PBX >> PBX System

ISDN1-S0

<p>Call Feature</p> <p><input type="checkbox"/> Hotline <input style="width: 100px;" type="text"/></p> <p><input type="checkbox"/> Session Timer <input style="width: 50px;" type="text"/> sec</p> <p><input type="checkbox"/> DND(Do Not Disturb) Mode Index(1-15) in Schedule Setup: <input type="checkbox"/>, <input type="checkbox"/>, <input type="checkbox"/>, <input type="checkbox"/></p> <p>Note: Action and Idle Timeout settings will be ignored.</p> <p><input type="checkbox"/> CLIR (hide caller ID)</p> <p><input type="checkbox"/> Call Waiting</p> <p><input type="checkbox"/> Call Transfer</p>	<p>Codecs</p> <p>Prefer Codec <input style="width: 100px;" type="text" value="G.729A/B (8Kbps)"/></p> <p><input type="checkbox"/> Single Codec</p> <p>Packet Size <input style="width: 50px;" type="text" value="20ms"/></p> <p>Voice Active Detector <input style="width: 50px;" type="text" value="Off"/></p>
---	--

Hotline

Check the box to enable it. Type in the SIP URL in the field for dialing automatically when you pick up the phone set.

Session Timer

Check the box to enable the function. In the limited time that you set in this field, if there is no response, the connecting call will be closed automatically.

DND (Do Not Disturb) mode

Set a period of peace time without disturbing by VoIP phone call. During the period, the one who dial in will listen busy tone, yet the local user will not listen any ring tone.

Index (1-15) in Schedule - Enter the index of schedule profiles to control the DND mode according to the preconfigured schedules. Refer to section **Applications>> Schedule** for detailed configuration.

CLIR (hide caller ID)

Check this box to hide the caller ID on the display panel of the phone set.

Call Waiting

Check this box to invoke this function. A notice sound will appear to tell the user new phone call is waiting for your response. Click hook flash to pick up the waiting phone call.

Call Transfer

Check this box to invoke this function. Click hook flash to initiate another phone call. When the phone call connection succeeds, hang up the phone. The other two sides can communicate, then.

Codecs

Prefer Codec - Select one of five codecs as the default for your VoIP calls. The codec used for each call will be negotiated with the peer party before each session, and so may not be your default choice. The default codec is G.729A/B; it occupies little bandwidth while maintaining

good voice quality.

If your upstream speed is only 64Kbps, do not use G.711 codec. It is better for you to have at least 256Kbps upstream if you would like to use G.711.

Prefer Codec

G.711A (64Kbps)	▼
G.711MU (64Kbps)	
G.711A (64Kbps)	
G.729A/B (8Kbps)	
G.723 (6.4kbps)	
G.726_32 (32kbps)	

Single Codec – If the box is checked, only the selected Codec will be applied.

Packet Size - The amount of data contained in a single packet. The default value is 20 ms, which means the data packet will contain 20 ms voice information.

Packet Size

20ms	▼
10ms	
20ms	
30ms	
40ms	
50ms	
60ms	

Voice Active Detector - This function can detect if the voice on both sides is active or not. If not, the router will do something to save the bandwidth for other using. Click On to invoke this function; click off to close the function.

Voice Active Detector

Off	▼
Off	
On	

In addition, you can press the **Advanced** button to configure tone settings, volume gain, MISC, DTMF mode and MSN number. **Advanced** setting is provided for fitting the telecommunication custom for the local area of the router installed. Wrong tone settings might cause inconvenience for users. To set the sound pattern of the phone set, simply choose a proper region to let the system find out the preset tone settings and caller ID type automatically. Or you can adjust tone settings manually if you choose User Defined. TOn1, TOff1, TOn2 and TOff2 mean the cadence of the tone pattern. TOn1 and TOn2 represent sound-on; TOff1 and TOff2 represent the sound-off.

Advance Settings >> ISDN1-S0

Tone Settings

Region

	Low Freq (Hz)	High Freq (Hz)	T on 1 (msec)	T off 1 (msec)	T on 2 (msec)	T off 2 (msec)
Dial tone	350	440	0	0	0	0
Ringing tone	400	450	400	200	400	2000
Busy tone	400	0	375	375	0	0
Congestion tone	0	0	0	0	0	0

Volume Gain

Mic Gain(1-10)

Speaker Gain(1-10)

DTMF

DTMF Mode

Payload Type (RFC2833) (96 - 127)

MISC

Dial Tone Power Level (1 - 35)

Ring Frequency (10 - 50HZ)

Region

Select the proper region which you are located. The common settings of **Caller ID Type**, **Dial tone**, **Ringing tone**, **Busy tone** and **Congestion tone** will be shown automatically on the page. If you cannot find out a suitable one, please choose **User Defined** and fill out the corresponding values for dial tone, ringing tone, busy tone, congestion tone by yourself for VoIP phone.



Also, you can specify each field for your necessity. It is recommended for you to use the default settings for VoIP communication.

Volume Gain

Mic Gain (1-10)/Speaker Gain (1-10) - Adjust the volume of microphone and speaker by entering number from 1- 10. The larger of the number, the louder the

volume is.

MISC

Dial Tone Power Level - This setting is used to adjust the loudness of the dial tone. The smaller the number is, the louder the dial tone is. It is recommended for you to use the default setting.

Ring Frequency - This setting is used to drive the frequency of the ring tone. It is recommended for you to use the default setting.

DTMF

DTMF Mode – There are four DTMF modes for you to choose.

InBand - Choose this one then the Vigor will send the DTMF tone as audio directly when you press the keypad on the phone

OutBand - Choose this one then the Vigor will capture the keypad number you pressed and transform it to digital form then send to the other side; the receiver will generate the tone according to the digital form it receive. This function is very useful when the network traffic congestion occurs and it still can remain the accuracy of DTMF tone.

SIP INFO- Choose this one then the Vigor will capture the DTMF tone and transfer it into SIP form. Then it will be sent to the remote end with SIP message.

DTMF mode

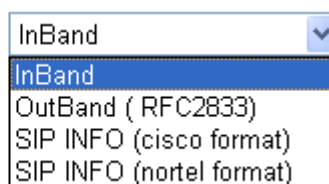

Payload Type (rfc2833) - Choose a number from 96 to 127, the default value was 101. This setting is available for the OutBand (RFC2833) mode.

Detailed Settings for ISDN1/2-TE Port

The vigor router allows users to switch the function of ISDN1/ISDN2 port between TE or S0 mode. Please use the drop down list to choose the one you want.



Choose ISDN-TE and click the number link for that port, you will see the following page.

ISDN2-TE

<p>Call Feature</p> <p><input type="checkbox"/> Session Timer 90 sec</p> <p><input type="checkbox"/> DND(Do Not Disturb) Mode Index(1-15) in Schedule Setup: <input type="checkbox"/>, <input type="checkbox"/>, <input type="checkbox"/>, <input type="checkbox"/></p> <p>Note: Action and Idle Timeout settings will be ignored.</p> <p><input type="checkbox"/> CLIR (hide caller ID)</p>	<p>Codecs</p> <p>Prefer Codec G.729A/B (8Kbps) ▾</p> <p><input type="checkbox"/> Single Codec</p> <p>Packet Size 20ms ▾</p> <p>Voice Active Detector Off ▾</p> <p>Extension Number 904</p>
--	--

Session Timer

Check the box to enable the function. In the limited time that you set in this field, if there is no response, the connecting call will be closed automatically.

DND (Do Not Disturb) mode

Set a period of peace time without disturbing by VoIP phone call. During the period, the one who dial in will listen busy tone, yet the local user will not listen any ring tone.

Index (1-15) in Schedule - Enter the index of schedule profiles to control the DND mode according to the preconfigured schedules. Refer to section **Applications>> Schedule** for detailed configuration.

CLIR (hide caller ID)

Check this box to hide the caller ID on the display panel of the phone set.

Codecs

Prefer Codec - Select one of five codecs as the default for your VoIP calls. The codec used for each call will be negotiated with the peer party before each session, and so may not be your default choice. The default codec is G.729A/B; it occupies little bandwidth while maintaining good voice quality.

If your upstream speed is only 64Kbps, do not use G.711 codec. It is better for you to have at least 256Kbps upstream if you would like to use G.711.

Prefer Codec

G.711A (64Kbps) ▾
G.711MU (64Kbps)
G.711A (64Kbps)
G.729A/B (8Kbps)
G.723 (6.4kbps)
G.726_32 (32kbps)

Single Codec – If the box is checked, only the selected Codec will be applied.

Packet Size-The amount of data contained in a single packet. The default value is 20 ms, which means the data packet will contain 20 ms voice information.

Packet Size

20ms	▼
10ms	
20ms	
30ms	
40ms	
50ms	
60ms	

Voice Active Detector - This function can detect if the voice on both sides is active or not. If not, the router will do something to save the bandwidth for other using. Click On to invoke this function; click off to close the function.

Voice Active Detector

Off	▼
Off	
On	

Extension Number

Type for specifying an extension number for such phone set.

In addition, you can press the **Advanced** button to configure tone settings, volume gain, MISC and DTMF mode. **Advanced** setting is provided for fitting the telecommunication custom for the local area of the router installed. Wrong tone settings might cause inconvenience for users. To set the sound pattern of the phone set, simply choose a proper region to let the system find out the preset tone settings and caller ID type automatically. Or you can adjust tone settings manually if you choose User Defined. TON1, TOff1, TOn2 and TOff2 mean the cadence of the tone pattern. TON1 and TOn2 represent sound-on; TOff1 and TOff2 represent the sound-off.

IP PBX >> Phone Settings

Advance Settings >> ISDN2-TE

Tone Settings						
Region	User Defined ▼					
	Low Freq (Hz)	High Freq (Hz)	T on 1 (msec)	T off 1 (msec)	T on 2 (msec)	T off 2 (msec)
Dial tone	350	440	0	0	0	0
Ringing tone	400	450	400	200	400	2000
Busy tone	400	0	375	375	0	0
Congestion tone	0	0	0	0	0	0
Volume Gain			DTMF			
Mic Gain(1-10)	5		DTMF Mode	OutBand (RFC2833) ▼		
Speaker Gain(1-10)	5		Payload Type (RFC2833) (96 - 127)	101		
MISC						
Dial Tone Power Level (1 - 35)	27					
Authentication PIN Code						
<input checked="" type="checkbox"/>	Check for ISDN to VoIP Calls	0000				
<input type="checkbox"/>	Check for VoIP to ISDN Calls	0000				

OK	Cancel
----	--------

Region

Select the proper region which you are located. The common settings of **Caller ID Type**, **Dial tone**, **Ringing tone**, **Busy tone** and **Congestion tone** will be shown

automatically on the page. If you cannot find out a suitable one, please choose **User Defined** and fill out the corresponding values for dial tone, ringing tone, busy tone, and congestion tone by yourself for VoIP phone.



Also, you can specify each field for your necessity. It is recommended for you to use the default settings for VoIP communication.

Volume Gain

Mic Gain (1-10)/Speaker Gain (1-10) - Adjust the volume of microphone and speaker by entering number from 1- 10. The larger of the number, the louder the volume is.

MISC

Dial Tone Power Level - This setting is used to adjust the loudness of the dial tone. The smaller the number is, the louder the dial tone is. It is recommended for you to use the default setting.

Authentication PIN Code

Check for ISDN to VoIP Calls – Set a pin code for the router to authenticate which one is allowed to dial ISDN to VoIP call. The figure that you can type in this field is limited from three to eight with digits from zero to nine.

Check for VoIP to ISDN Calls - Set a pin code for the router to authenticate which one is allowed to dial VoIP to ISDN call. The figure that you can type in this field is limited from three to eight with digits from zero to nine.

DTMP

DTMF mode – There are four selections provided here:

InBand: Choose this one then the Vigor will send the DTMF tone as audio directly when you press the keypad on the phone

OutBand: Choose this one then the Vigor will capture the keypad number you pressed and transform it to digital form then send to the other side; the receiver will generate the tone according to the digital form it receive. This

function is very useful when the network traffic congestion occurs and it still can remain the accuracy of DTMF tone.

SIP INFO: Choose this one then the Vigor will capture the DTMF tone and transfer it into SIP form. Then it will be sent to the remote end with SIP message.

DTMF mode

InBand	▼
InBand	
OutBand (RFC2833)	
SIP INFO (cisco format)	
SIP INFO (nortel format)	

Payload Type (rfc2833) - Choose a number from 96 to 127, the default value was 101. This setting is available for the OutBand (RFC2833) mode.

Detailed Settings for FXO Port

Click the number link of FXO port, you can access into the following page for configuring Phone settings. Below is the sample page for FXO port.

[IP PBX >> PBX System](#)

FXO

Call Feature <input type="checkbox"/> Session Timer 90 sec <input type="checkbox"/> DND(Do Not Disturb) Mode Index(1-15) in Schedule Setup: <input type="text"/> , <input type="text"/> , <input type="text"/> , <input type="text"/> Note: Action and Idle Timeout settings will be ignored. <input type="checkbox"/> CLIR (hide caller ID)	Codecs Prefer Codec G.729A/B (8Kbps) ▾ <input type="checkbox"/> Single Codec Packet Size 20ms ▾ Voice Active Detector Off ▾
---	---

OK Cancel Advanced

Session Timer

Check the box to enable the function. In the limited time that you set in this field, if there is no response, the connecting call will be closed automatically.

DND (Do Not Disturb) mode

Set a period of peace time without disturbing by VoIP phone call. During the period, the one who dial in will listen busy tone, yet the local user will not listen any ring tone.

Index (1-15) in Schedule - Enter the index of schedule profiles to control the DND mode according to the preconfigured schedules. Refer to section **Applications>> Schedule** for detailed configuration.

CLIR (hide caller ID)

Check this box to hide the caller ID on the display panel of the phone set.

Codecs

Prefer Codec - Select one of five codecs as the default for your VoIP calls. The codec used for each call will be negotiated with the peer party before each session, and so may not be your default choice. The default codec is G.729A/B; it occupies little bandwidth while maintaining good voice quality.

If your upstream speed is only 64Kbps, do not use G.711 codec. It is better for you to have at least 256Kbps upstream if you would like to use G.711.

Prefer Codec

G.711A (64Kbps) ▾
G.711MU (64Kbps)
G.711A (64Kbps)
G.729A/B (8Kbps)
G.723 (6.4kbps)
G.726_32 (32kbps)

Single Codec – If the box is checked, only the selected Codec will be applied.

Packet Size-The amount of data contained in a single packet. The default value is 20 ms, which means the data

packet will contain 20 ms voice information.

Packet Size

- 10ms
- 20ms**
- 30ms
- 40ms
- 50ms
- 60ms

Voice Active Detector - This function can detect if the voice on both sides is active or not. If not, the router will do something to save the bandwidth for other using. Click On to invoke this function; click off to close the function.

Voice Active Detector

- Off**
- On

In addition, you can press the **Advanced** button to configure tone settings, volume gain, MISC and DTMF mode. **Advanced** setting is provided for fitting the telecommunication custom for the local area of the router installed. Wrong tone settings might cause inconvenience for users. To set the sound pattern of the phone set, simply choose a proper region to let the system find out the preset tone settings and caller ID type automatically. Or you can adjust tone settings manually if you choose User Defined. TOn1, TOff1, TOn2 and TOff2 mean the cadence of the tone pattern. TOn1 and TOn2 represent sound-on; TOff1 and TOff2 represent the sound-off.

[IP PBX >> Phone Settings](#)

[Advance Settings >> FXO](#)

Tone Settings

Region

	Low Freq (Hz)	High Freq (Hz)	T on 1 (msec)	T off 1 (msec)	T on 2 (msec)	T off 2 (msec)
Dial tone	<input type="text" value="425"/>	<input type="text" value="0"/>	<input type="text" value="0"/>	<input type="text" value="0"/>	<input type="text" value="0"/>	<input type="text" value="0"/>
Ringing tone	<input type="text" value="425"/>	<input type="text" value="0"/>	<input type="text" value="1000"/>	<input type="text" value="4000"/>	<input type="text" value="0"/>	<input type="text" value="0"/>
Busy tone	<input type="text" value="425"/>	<input type="text" value="0"/>	<input type="text" value="500"/>	<input type="text" value="500"/>	<input type="text" value="0"/>	<input type="text" value="0"/>
Congestion tone	<input type="text" value="0"/>	<input type="text" value="0"/>	<input type="text" value="0"/>	<input type="text" value="0"/>	<input type="text" value="0"/>	<input type="text" value="0"/>

Volume Gain

Mic Gain(1-10)

Speaker Gain(1-10)

MISC

Dial Tone Power Level (1 - 50)

DTMF

DTMF Mode

Payload Type (RFC2833) (96 - 127)

Region

Select the proper region which you are located. The common settings of **Caller ID Type**, **Dial tone**, **Ringing tone**, **Busy tone** and **Congestion tone** will be shown automatically on the page. If you cannot find out a suitable one, please choose **User Defined** and fill out the corresponding values for dial tone, ringing tone, busy tone, and congestion tone by yourself for VoIP phone.



Also, you can specify each field for your necessity. It is recommended for you to use the default settings for VoIP communication.

Volume Gain

Mic Gain (1-10)/Speaker Gain (1-10) - Adjust the volume of microphone and speaker by entering number from 1- 10. The larger of the number, the louder the volume is.

MISC

Dial Tone Power Level - This setting is used to adjust the loudness of the dial tone. The smaller the number is, the louder the dial tone is. It is recommended for you to use the default setting.

DTMP

DTMF mode – There are four selections provided here:

InBand: Choose this one then the Vigor will send the DTMF tone as audio directly when you press the keypad on the phone

OutBand: Choose this one then the Vigor will capture the keypad number you pressed and transform it to digital form then send to the other side; the receiver will generate the tone according to the digital form it receive. This function is very useful when the network traffic congestion occurs and it still can remain the accuracy of DTMF tone.

SIP INFO: Choose this one then the Vigor will capture the DTMF tone and transfer it into SIP form. Then it will be sent to the remote end with SIP message.

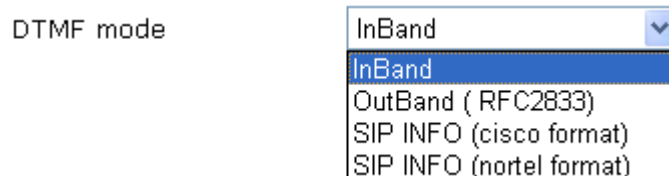

Payload Type (rfc2833) - Choose a number from 96 to 127, the default value was 101. This setting is available for the OutBand (RFC2833) mode.

Four ISDN Channels Application

There are two ISDN physical connectors for connecting to ISDN phones. However, if these two ISDN connectors are configured with ISDN-TE port from the web page, LAN users can connect to four ISDN phones at one time through ISDN PBX system.

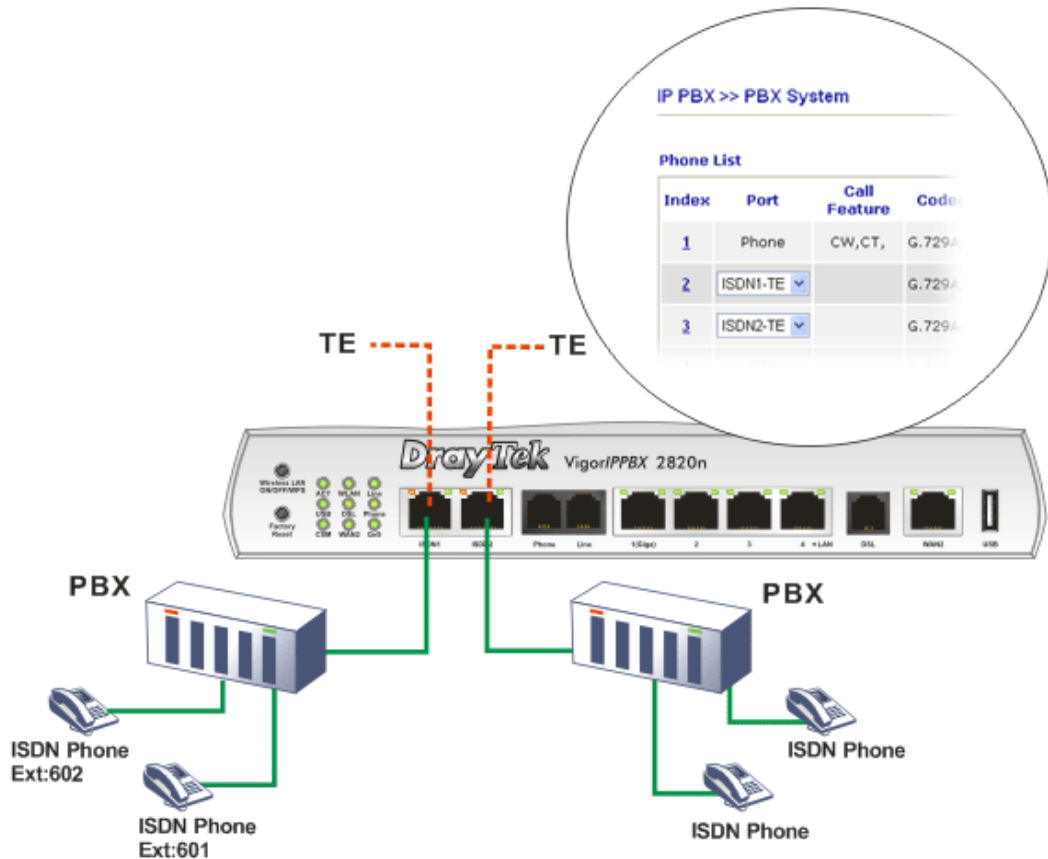

Follow the steps below to configure the phone ports with features of ISDN-TE.

1. Open **IP PBX >> PBX System**.
2. Click **Phone Settings** to open the configuration page.

IP PBX >> PBX System

Phone List Refresh Seco

Index	Port	Call Feature	Codec	Tone	Gain (Mic/Speaker)	Ex
1	Phone	CW,CT,	G.729A/B	User Defined	5/5	
2	ISDN1-TE		G.729A/B	User Defined	5/5	
3	ISDN2-TE		G.729A/B	User Defined	5/5	
4	FXO		G.729A/B	User Defined	5/5	

3. Choose **ISDN1-TE** as the **Port** setting in index 2 and **ISDN2-TE** as the **Port** setting in index 3.

4. Click **OK** to save the change.
5. Next, click index 2 link / index 3 link to configure detailed settings for each port respectively.

When you finished the configuration, four ISDN lines are ready for the user to communicate with others.

5.12.4.8 SIP Trunk and Extension Configuration Backup

This page allows you to backup or restore SIP Trunk and Extension Configuration to the host and restore them to the router if required.

IP PBX >> SIP Trunk and Extension Configuration Backup

SIP Trunk Setting Backup / Restoration

Restoration

Select a SIPTrunk_Setting.bak file.

Click Restore to upload the file.

Backup

Click Backup to download current running sip trunk settings as a file.

Extension Setting Backup / Restoration

Restoration

Select a Ext_Setting.bak file.

Click Restore to upload the file.

Backup

Click Backup to download current running extension settings as a file.

Backup the Configuration for SIP Trunk or Extension Settings

Follow the steps below to backup your configuration.

1. Click **Backup** button. A dialog appears for you to confirm the settings backup. Click **Save** button to open another dialog for saving configuration as a file.
2. In **Save As** dialog, the default filename is **v2820pbx_SIPTrunk_Setting_2010XXXX** (for SIP Trunk) or **v2820pbx_Ext_Setting_2010XXX** (for extension settings). You could give it another name by yourself.
3. Click **Save** button, the configuration will download automatically to your computer as a file named **v2820pbx_SIPTrunk_Setting_2010XXXX** (for SIP Trunk) or **v2820pbx_Ext_Setting_2010XXX** (for extension settings).

The above example is using **Windows** platform for demonstrating examples. The **Mac** or **Linux** platform will display different windows, but the backup function is still available.

Restore Configuration

1. Click **Browse** button in the field of Restoration to choose the correct configuration file for uploading to the router.
2. Click **Restore** button and wait for few seconds, the following picture will tell you that the restoration procedure is successful.

5.12.5 PBX Status

[IP PBX >> PBX Status](#)

PBX Status

Call Detail Records Extension Monitor
--

5.12.5.1 Call Detail Records

This page displays call records of IP PBX such as failed call, successful call, no-answer call, date of the call and the duration of each call, and so on.

[IP PBX >> PBX Status](#)

CDR Export

Click Export to download CDR record as a file(.csv).

Call Detail Records

Refresh Seconds:

| [Refresh](#) |

Index	Date	From	To	Result	Duration
1					
2					
3					
4					
5					
6					
7					
8					
9					
10					
11					
12					
13					
14					
15					
16					
17					
18					
19					
20					
21					
22					
23					
24					
25					
26					
27					
28					
29					
30					
31					
32					
33					
34					
35					
36					
37					
38					
39					
40					
41					
42					
43					
44					
45					
46					
47					
48					
49					
50					

<< [1-50](#) | [51-100](#) | [101-150](#) | [151-200](#) | [201-250](#) | [251-300](#) | [301-350](#) | [351-400](#) | [401-450](#) | [451-500](#)
 | [501-550](#) | [551-600](#) | [601-650](#) | [651-700](#) | [701-750](#) | [751-800](#) | [801-850](#) | [851-900](#) | [901-950](#) | [951-1000](#) >>

Such records can be exported as a file (with file format .csv) and stored in the host. Simply click **Export**.

5.12.5.2 Extension Monitor

This page displays owner's name, IP address, status and peer ID for each extension number.

[IP PBX >> PBX Status](#)

Extension Monitor Refresh Seconds: | [Refresh](#) |

Index	Name	Extension	IP	Status	Peer ID
1	---	---		Offline	
2	---	---		Offline	
3	---	---		Offline	
4	---	---		Offline	
5	---	---		Offline	
6	---	---		Offline	
7	---	---		Offline	
8	---	---		Offline	
9	---	---		Offline	
10	---	---		Offline	

[<< 1-10](#) | [11-20](#) | [21-30](#) | [31-40](#) | [41-50](#) >>

[Next >>](#)

5.13 Wireless LAN

This function is used for “n” models only.

5.13.1 Basic Concepts

Over recent years, the market for wireless communications has enjoyed tremendous growth. Wireless technology now reaches or is capable of reaching virtually every location on the surface of the earth. Hundreds of millions of people exchange information every day via wireless communication products. The Vigor “n” model, a.k.a. Vigor wireless router, is designed for maximum flexibility and efficiency of a small office/home. Any authorized staff can bring a built-in WLAN client PDA or notebook into a meeting room for conference without laying a clot of LAN cable or drilling holes everywhere. Wireless LAN enables high mobility so WLAN users can simultaneously access all LAN facilities just like on a wired LAN as well as Internet access.

The Vigor wireless routers are equipped with a wireless LAN interface compliant with the standard IEEE 802.11n protocol. To boost its performance further, the Vigor Router is also loaded with advanced wireless technology to lift up data rate up to 300 Mbps*. Hence, you can finally smoothly enjoy stream music and video.

Note: * The actual data throughput will vary according to the network conditions and environmental factors, including volume of network traffic, network overhead and building materials.

In an Infrastructure Mode of wireless network, Vigor wireless router plays a role as an Access Point (AP) connecting to lots of wireless clients or Stations (STA). All the STAs will share the same Internet connection via Vigor wireless router. The **General Settings** will set up the information of this wireless network, including its SSID as identification, located channel etc.

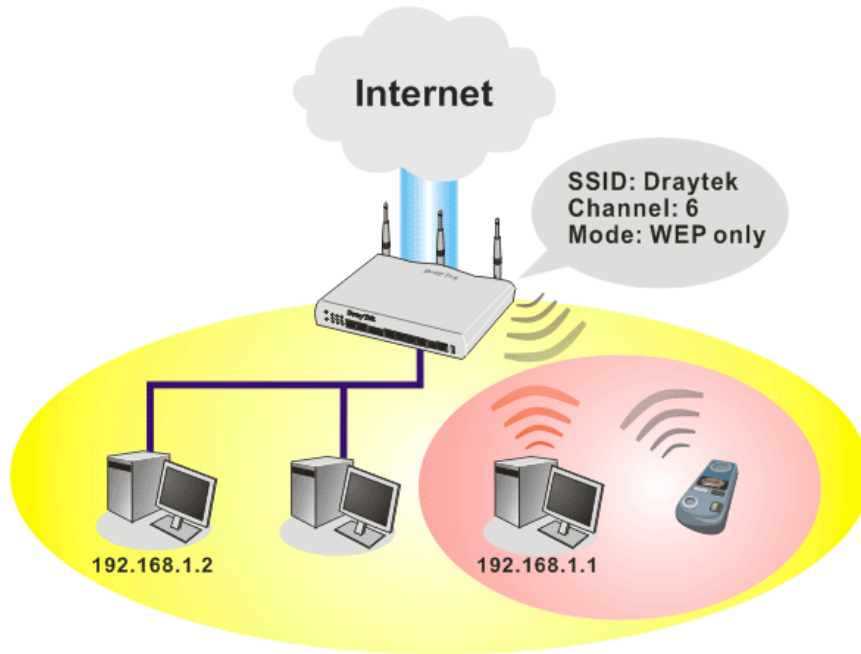

Security Overview

Real-time Hardware Encryption: Vigor Router is equipped with a hardware AES encryption engine so it can apply the highest protection to your data without influencing user experience.

Complete Security Standard Selection: To ensure the security and privacy of your wireless communication, we provide several prevailing standards on market.

WEP (Wired Equivalent Privacy) is a legacy method to encrypt each frame transmitted via radio using either a 64-bit or 128-bit key. Usually access point will preset a set of four keys and it will communicate with each station using only one out of the four keys.

WPA (Wi-Fi Protected Access), the most dominating security mechanism in industry, is separated into two categories: WPA-personal or called WPA Pre-Share Key (WPA/PSK), and WPA-Enterprise or called WPA/802.1x.

In WPA-Personal, a pre-defined key is used for encryption during data transmission. WPA applies Temporal Key Integrity Protocol (TKIP) for data encryption while WPA2 applies AES. The WPA-Enterprise combines not only encryption but also authentication.

Since WEP has been proved vulnerable, you may consider using WPA for the most secure connection. You should select the appropriate security mechanism according to your needs. No matter which security suite you select, they all will enhance the over-the-air data protection and /or privacy on your wireless network. The Vigor wireless router is very flexible and can support multiple secure connections with both WEP and WPA at the same time.

Separate the Wireless and the Wired LAN- WLAN Isolation enables you to isolate your wireless LAN from wired LAN for either quarantine or limit access reasons. To isolate means neither of the parties can access each other. To elaborate an example for business use, you may set up a wireless LAN for visitors only so they can connect to Internet without hassle of the confidential information leakage. For a more flexible deployment, you may add filters of MAC addresses to isolate users' access from wired LAN.

Manage Wireless Stations - Station List will display all the station in your wireless network and the status of their connection.

Below shows the menu items for Wireless LAN.

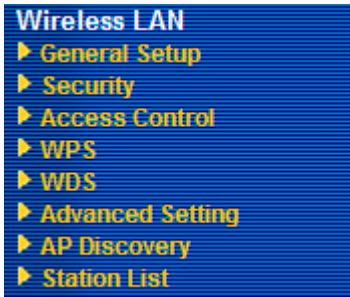

5.13.2 General Setup

By clicking the **General Settings**, a new web page will appear so that you could configure the SSID and the wireless channel. Please refer to the following figure for more information.

Wireless LAN >> General Setup

General Setting (IEEE 802.11)

Enable Wireless LAN

Mode : Mixed(11b+11g+11n) v

Index(1-15) in [Schedule](#) Setup: , , ,

Only schedule profiles that have the action "Force Down" are applied to the WLAN, all other actions are ignored.

	Enable	Hide SSID	SSID	Member	VPN
1	<input type="checkbox"/>	<input type="checkbox"/>	DrayTek	<input type="checkbox"/>	<input type="checkbox"/>
2	<input type="checkbox"/>	<input type="checkbox"/>		<input type="checkbox"/>	<input type="checkbox"/>
3	<input type="checkbox"/>	<input type="checkbox"/>		<input type="checkbox"/>	<input type="checkbox"/>
4	<input type="checkbox"/>	<input type="checkbox"/>		<input type="checkbox"/>	<input type="checkbox"/>

Isolate Member: Wireless clients (stations) with the same SSID cannot access for each other.

Channel: Channel 6, 2437MHz v Long Preamble:

Long Preamble: necessary for some old 802.11 b devices only(lower performance)

Packet-OVERDRIVE™

Tx Burst

Note:
The same technology must also be supported in clients to boost WLAN performance.

	Enable	Upload	Download
SSID 1	<input type="checkbox"/>	30000 kbps	30000 kbps
SSID 2	<input type="checkbox"/>	30000 kbps	30000 kbps
SSID 3	<input type="checkbox"/>	30000 kbps	30000 kbps
SSID 4	<input type="checkbox"/>	30000 kbps	30000 kbps

Note: range 100~50,000 kbps

OK
Cancel

Enable Wireless LAN

Check the box to enable wireless function.

Mode

At present, the router can connect to 11b Only, 11g Only, 11n Only, Mixed(11b+11g), Mixed(11g+11n) and Mixed(11b+11g+11n) stations simultaneously. Simply choose

Mix (11b+11g+11n) mode.

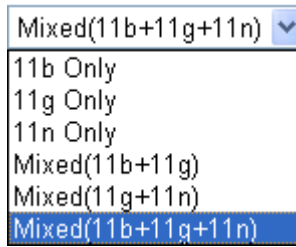

Index(1-15)

Set the wireless LAN to work at certain time interval only. You may choose up to 4 schedules out of the 15 schedules pre-defined in **Applications >> Schedule** setup. The default setting of this filed is blank and the function will always work.

Hide SSID

Check it to prevent from wireless sniffing and make it harder for unauthorized clients or STAs to join your wireless LAN. Depending on the wireless utility, the user may only see the information except SSID or just cannot see any thing about Vigor wireless router while site surveying. The system allows you to set four sets of SSID for different usage. In default, the first set of SSID will be enabled. You can hide it for your necessity.

SSID

Means the identification of the wireless LAN. SSID can be any text numbers or various special characters. The default SSID is "default". We suggest you to change it.

Member

Check this box to make the wireless clients (stations) with the same SSID not accessing for each other.

VPN

Check this box to make wireless clients (stations) with the same SSID not accessing for VPN connection.

Channel

Means the channel of frequency of the wireless LAN. The default channel is 6. You may switch channel if the selected channel is under serious interference. If you have no idea of choosing the frequency, please select Auto to let system determine for you.

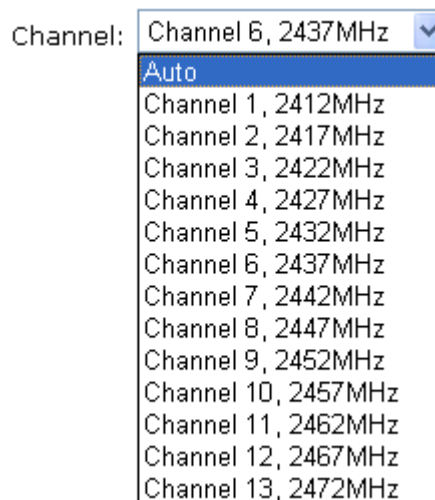

Long Preamble

This option is to define the length of the sync field in an 802.11 packet. Most modern wireless network uses short preamble with 56 bit sync field instead of long preamble with 128 bit sync field. However, some original 11b wireless network devices only support long preamble. Check it to use **Long Preamble** if needed to communicate with this kind of devices.

Packet-OVERDRIVE

This feature can enhance the performance in data transmission about 40% for 11g (5% for 11n) by checking **Tx Burst**. It is active only when both sides of Access Point and Station (in wireless client) invoke this function at the same time. That is, the wireless client must support this feature and invoke the function, too.

Note: Vigor N61 wireless adapter supports this function. Therefore, you can use and install it into your PC for matching with Packet-OVERDRIVE (refer to the following picture of Vigor N61 wireless utility window, choose **Enable** for **TxBURST** on the tab of **Option**).

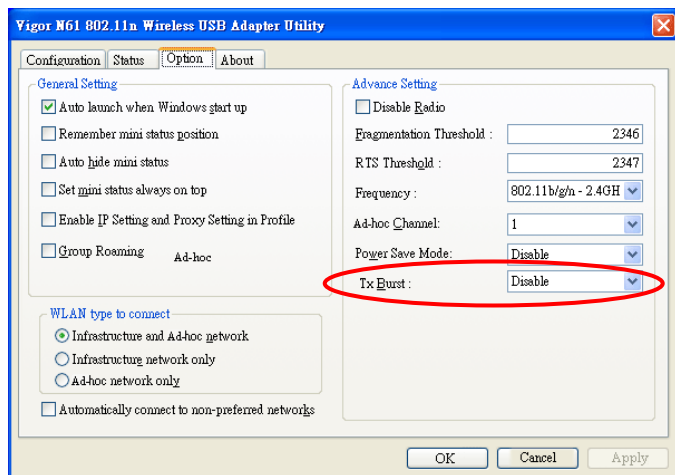

Rate Control

It controls the data transmission rate through wireless connection.

Upload – Check Enable and type the transmitting rate for data upload. Default value is 30,000 kbps.

Download – Type the transmitting rate for data download. Default value is 30,000 kbps.

5.13.3 Security

This page allows you to set security with different modes for SSID 1, 2, 3 and 4 respectively. After configuring the correct settings, please click **OK** to save and invoke it.

By clicking the **Security Settings**, a new web page will appear so that you could configure the settings of WEP and WPA.

[Wireless LAN >> Security Settings](#)

SSID 1	SSID 2	SSID 3	SSID 4
Mode: <input type="text" value="WPA/PSK"/>			
Set up RADIUS Server if 802.1x is enabled.			
WPA:			
Encryption Mode: <input type="text" value="TKIP"/>			
Pre-Shared Key(PSK): <input type="text" value="*****"/>			
Type 8~63 ASCII character or 64 Hexadecimal digits leading by "0x", for example "cfgs01a2..." or "0x655abcd....".			
WEP:			
Encryption Mode: <input type="text" value="64-Bit"/>			
<input checked="" type="radio"/> Key 1 : <input type="text" value="*****"/>			
<input type="radio"/> Key 2 : <input type="text" value="*****"/>			
<input type="radio"/> Key 3 : <input type="text" value="*****"/>			
<input type="radio"/> Key 4 : <input type="text" value="*****"/>			
For 64 bit WEP key Type 5 ASCII character or 10 Hexadecimal digits leading by "0x", for example "AB312" or "0x4142333132".			
For 128 bit WEP key Type 13 ASCII character or 26 Hexadecimal digits leading by "0x", for example "0123456789abc" or "0x30313233343536373839414243".			
<input type="button" value="OK"/> <input type="button" value="Cancel"/>			

Mode

There are several modes provided for you to choose.

<input type="text" value="WPA/PSK"/>
Disable WEP WEP/802.1x Only WPA/802.1x Only WPA2/802.1x Only Mixed(WPA+WPA2/802.1x only) WPA/PSK WPA2/PSK Mixed(WPA+WPA2)/PSK

Disable - Turn off the encryption mechanism.

WEP-Accepts only WEP clients and the encryption key should be entered in WEP Key.

WEP/802.1x Only - Accepts only WEP clients and the encryption key is obtained dynamically from RADIUS server with 802.1X protocol.

WPA/802.1x Only- Accepts only WPA clients and the encryption key is obtained dynamically from RADIUS server with 802.1X protocol.

WPA2/802.1x Only- Accepts only WPA2 clients and the encryption key is obtained dynamically from RADIUS server with 802.1X protocol.

Mixed (WPA+WPA2/802.1x only) - Accepts WPA and WPA2 clients simultaneously and the encryption key is obtained dynamically from RADIUS server with 802.1X protocol.

WPA/PSK-Accepts only WPA clients and the encryption key should be entered in PSK.

WPA2/PSK-Accepts only WPA2 clients and the encryption key should be entered in PSK.

Mixed (WPA+ WPA2)/PSK - Accepts WPA and WPA2 clients simultaneously and the encryption key should be entered in PSK.

Note: You should also set RADIUS Server simultaneously if WEP/802.1x Only, WPA/802.1x Only, WPA2/802.1x Only or Mixed (WPA+WPA2/802.1x only) is selected.

WPA

The WPA encrypts each frame transmitted from the radio using the key, which either PSK (Pre-Shared Key) entered manually in this field below or automatically negotiated via 802.1x authentication. Either **8~63** ASCII characters, such as 012345678(or 64 Hexadecimal digits leading by 0x, such as "0x321253abcde...").

Type - Select from Mixed (WPA+WPA2) or WPA2 only.

Pre-Shared Key (PSK) - Either **8~63** ASCII characters, such as 012345678..(or 64 Hexadecimal digits leading by 0x, such as "0x321253abcde...").

WEP

64-Bit - For 64 bits WEP key, either **5** ASCII characters, such as 12345 (or 10 hexadecimal digitals leading by 0x, such as 0x4142434445.)

128-Bit - For 128 bits WEP key, either **13** ASCII characters, such as ABCDEFGHIJKLM (or 26 hexadecimal digits leading by 0x, such as 0x414243444546474849A4B4C4D).

Encryption Mode:

64-Bit	▼
64-Bit	
128-Bit	

All wireless devices must support the same WEP encryption bit size and have the same key. **Four keys** can be entered here, but only one key can be selected at a time. The keys can be entered in ASCII or Hexadecimal. Check the key you wish to use.

5.13.4 Access Control

In the **Access Control**, the router may restrict wireless access to certain wireless clients only by locking their MAC address into a black or white list. The user may block wireless clients by inserting their MAC addresses into a black list, or only let them be able to connect by inserting their MAC addresses into a white list. In the **Access Control** web page, users may configure the white/black list modes used by each SSID and the MAC addresses applied to their lists.

[Wireless LAN >> Access Control](#)

Access Control

Enable Mac Address Filter SSID 1 White List SSID 2 White List
 SSID 3 White List SSID 4 White List

MAC Address Filter

Index	Attribute	MAC Address	Apply SSID
<div style="border: 1px solid #ccc; width: 100%; height: 100%;"></div>			

Client's MAC Address : : : : : :

Apply SSID : SSID 1 SSID 2 SSID 3 SSID 4

Attribute : s: Isolate the station from LAN

Enable Mac Access Filter	Select the access control filter type to be applied to wireless LAN identified with SSID 1 to 4 respectively.
MAC Address Filter	Display all access control entries that were inserted before.
Client's MAC Address	Manually enter the MAC address of wireless client.
Apply SSID	After entering the client's MAC address, check the box of the SSIDs desired to insert this MAC address into their access control list.
Attribute	s: Isolate the station from LAN - select to isolate the wireless client from the wired LAN network.
Add	Add a new access control entry into the list.
Delete	Delete the selected access control entry in the list.
Edit	Edit the selected access control entry in the list.
Cancel	Give up current modified settings.
OK	Click it to save the settings in access control list.
Clear All	Clean all entries in the MAC address list.

5.13.5 WPS

WPS (Wi-Fi Protected Setup) provides easy procedure to make network connection between wireless station and wireless access point (vigor router) with the encryption of WPA and WPA2.

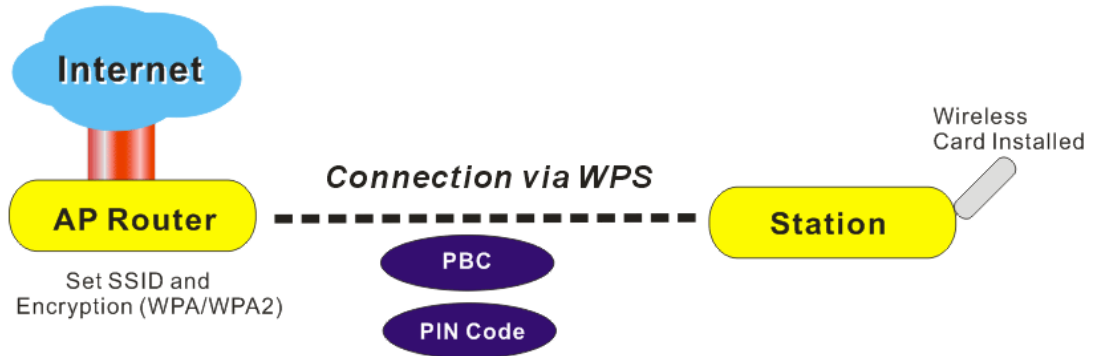

Note: Such function is available for the wireless station with WPS supported.

It is the simplest way to build connection between wireless network clients and vigor router. Users do not need to select any encryption mode and type any long encryption passphrase to setup a wireless client every time. He/she only needs to press the **WPS** button on AP and selects that AP on the utility of wireless station. Then WPS will connect for client and router automatically.

There are two methods to do network connection through WPS between AP and Stations: pressing the *Start PBC* button or using *PIN Code*.

- On the side of VigorIPPBX 2820 series which served as an AP, press **Wireless LAN ON/OFF/WPS** button for 2 seconds to wait for client device making network connection through WPS or click **Start PBC** on web configuration interface. On the side of a station with network card installed, press **Start PBC** button of network card.

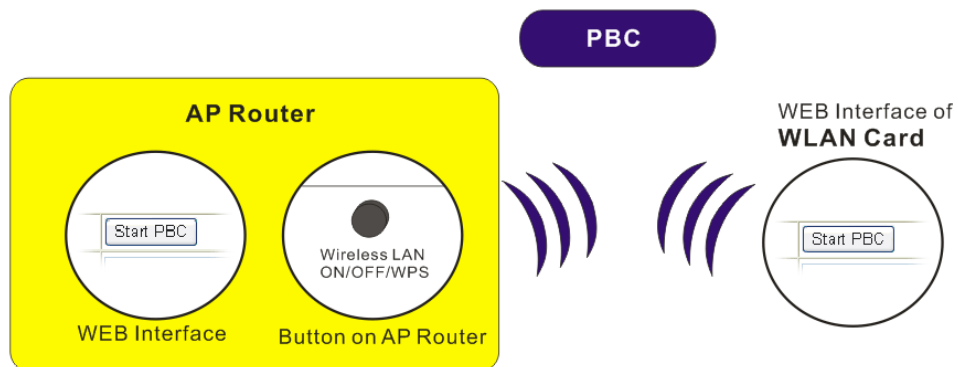

- If you want to use PIN code, you have to know the PIN code specified in wireless client. Then provide the PIN code of the wireless client you wish to connect to the vigor router.

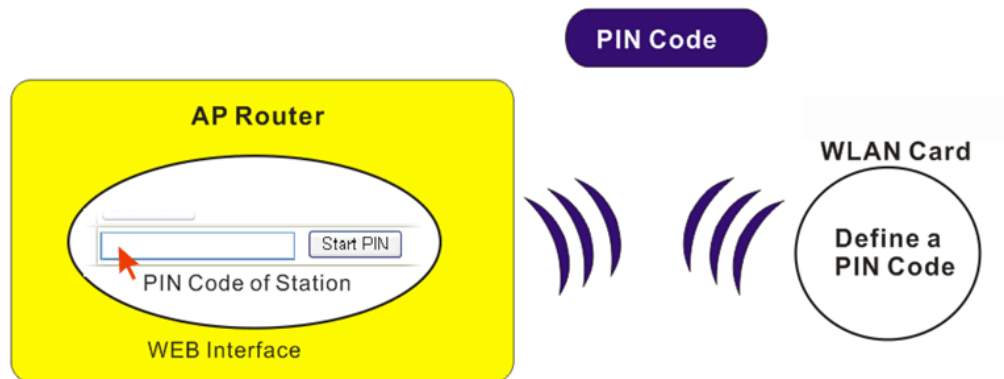

For WPS is supported in WPA-PSK or WPA2-PSK mode, if you do not choose such mode in **Wireless LAN>>Security**, you will see the following message box.

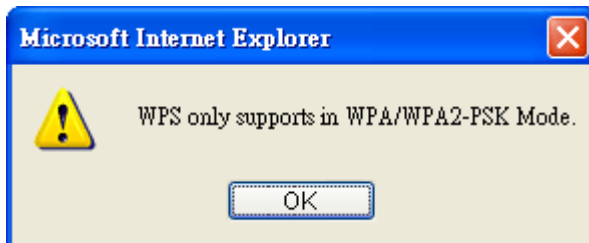

Please click **OK** and go back **Wireless LAN>>Security** to choose WPA-PSK or WPA2-PSK mode and access WPS again.

Below shows **Wireless LAN>>WPS** web page.

Wireless LAN >> WPS (Wi-Fi Protected Setup)

Enable WPS

Wi-Fi Protected Setup Information

WPS Status	Configured
SSID	DrayTek
Authentication Mode	Disable

Device Configure

Configure via Push Button	<input type="button" value="Start PBC"/>
Configure via Client PinCode	<input type="text"/> <input type="button" value="Start PIN"/>

Status: The Authentication Mode is NOT WPA/WPA2 PSK!!

Note: WPS can help your wireless client automatically connect to the Access point.

: WPS is Disabled.

: WPS is Enabled.

: Waiting for WPS requests from wireless clients.

Enable WPS

Check this box to enable WPS setting.

WPS Status

Display related system information for WPS.

SSID

Display the SSID1 of the router. WPS is supported by SSID1 only.

Authentication Mode	Display current authentication mode of the router. Only WPA2/PSK and WPA/PSK support WPS.
Configure via Push Button	Click Start PBC to invoke Push-Button style WPS setup procedure. The router will wait for WPS requests from wireless clients about two minutes. The WPS LED on the router will blink fast when WPS is in progress. It will return to normal condition after two minutes. (You need to setup WPS within two minutes)
Configure via Client PinCode	Please input the PIN code specified in wireless client you wish to connect, and click Start PIN button. The WLAN LED on the router will blink fast when WPS is in progress. It will return to normal condition after two minutes. (You need to setup WPS within two minutes)

5.13.6 WDS

WDS means Wireless Distribution System. It is a protocol for connecting two access points (AP) wirelessly. Usually, it can be used for the following application:

- Provide bridge traffic between two LANs through the air.
- Extend the coverage range of a WLAN.

To meet the above requirement, two WDS modes are implemented in Vigor router. One is **Bridge**, the other is **Repeater**. Below shows the function of WDS-bridge interface:

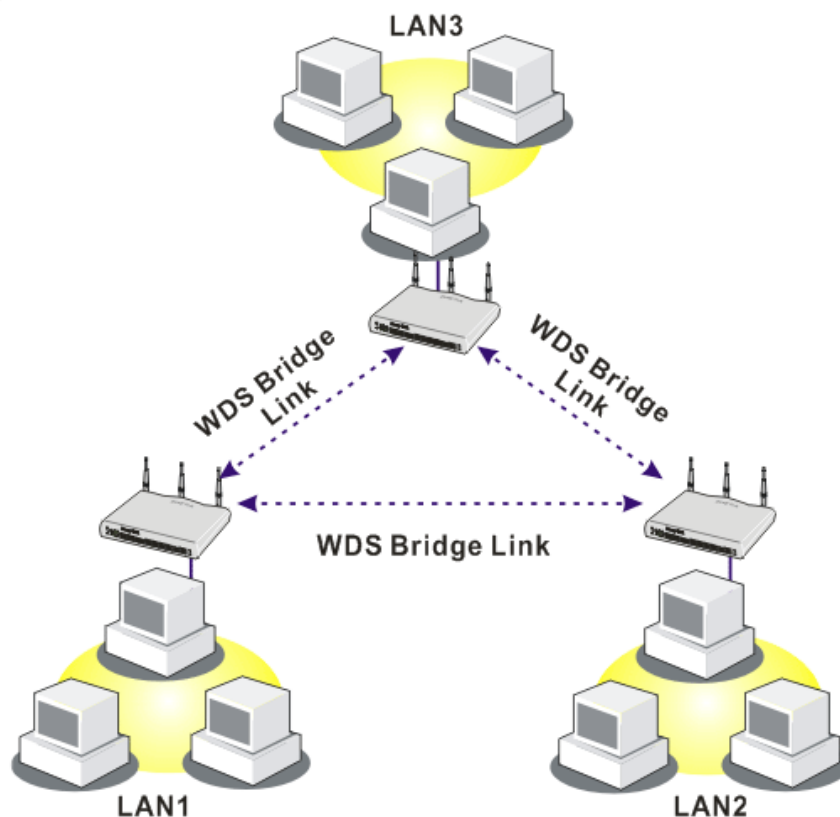

The application for the WDS-Repeater mode is depicted as below:

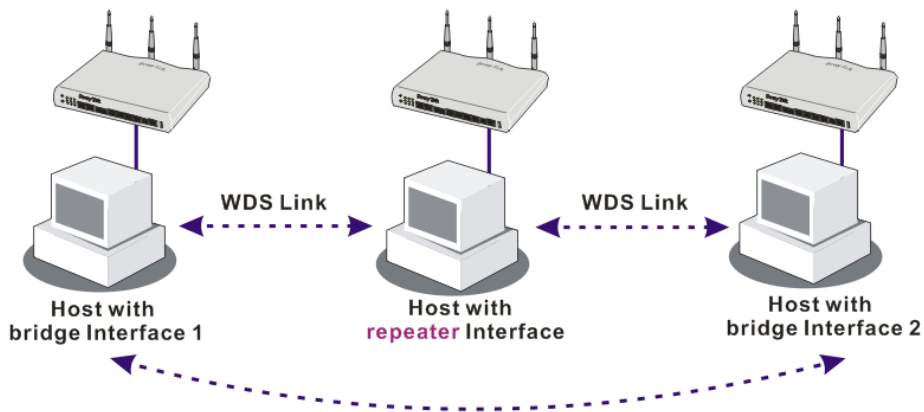

The major difference between these two modes is that: while in **Repeater** mode, the packets received from one peer AP can be repeated to another peer AP through WDS links. Yet in **Bridge** mode, packets received from a WDS link will only be forwarded to local wired or wireless hosts. In other words, only Repeater mode can do WDS-to-WDS packet forwarding.

In the following examples, hosts connected to Bridge 1 or 3 can communicate with hosts connected to Bridge 2 through WDS links. However, hosts connected to Bridge 1 CANNOT communicate with hosts connected to Bridge 3 through Bridge 2.

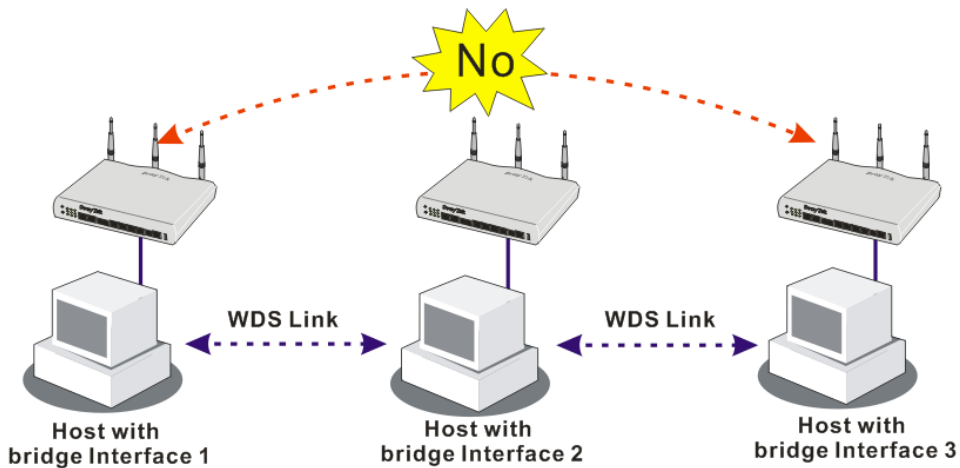

Click **WDS** from **Wireless LAN** menu. The following page will be shown.

WDS Settings
[Set to Factory Default](#)

Mode: Repeater

Security:

Disable
 WEP
 Pre-shared Key

WEP:

Use the same WEP key set in [Security Settings](#).

Pre-shared Key:

Type:

DrayTek WPA
 WPA
 WPA2

Key: :*****

Type 8~63 ASCII characters or 64 hexadecimal digits leading by "0x", for example "cfigs01a2..." or "0x655abcd....".

Bridge

Enable Peer MAC Address

[] : [] : [] : [] : [] : []
 [] : [] : [] : [] : [] : []
 [] : [] : [] : [] : [] : []
 [] : [] : [] : [] : [] : []

Note: Disable unused links to get better performance.

Repeater

Enable Peer MAC Address

[] : [] : [] : [] : [] : []
 [] : [] : [] : [] : [] : []
 [] : [] : [] : [] : [] : []
 [] : [] : [] : [] : [] : []

Access Point Function:

Enable
 Disable

Status:

Send "Hello" message to peers.

Link Status

Note: The status is valid only when the peer also supports this function.

OK
Cancel

Mode

Choose the mode for WDS setting. **Disable** mode will not invoke any WDS setting. **Bridge** mode is designed to fulfill the first type of application. **Repeater** mode is for the second one.

Disable

Disable
Bridge
Repeater

Security

There are three types for security, **Disable**, **WEP** and **Pre-shared key**. The setting you choose here will make the following WEP or Pre-shared key field valid or not. Choose one of the types for the router.

WEP

Check this box to use the same key set in **Security Settings** page. If you did not set any key in **Security Settings** page, this check box will be dimmed.

Pre-shared Key

Type – There are three types for you to choose. **DrayTek WPA** can be used for all DrayTek wireless routers like Vigor2700, Vigor2800, Vigor2820, and etc., except for other brand's wireless routers. **WPA** and **WPA2** are used for WDS devices (e.g., AP700). For example, if you have a wireless AP and a Vigor2820n wireless router, you can set the encryption mode as WPA

or WPA2 to establish your WDS system between AP and the router.

Key - Type 8 ~ 63 ASCII characters or 64 hexadecimal digits leading by "0x".

Bridge

If you choose Bridge as the connecting mode, please type in the peer MAC address in these fields. Four peer MAC addresses are allowed to be entered in this page at one time. Yet please disable the unused link to get better performance. If you want to invoke the peer MAC address, remember to check **Enable** box in the front of the MAC address after typing.

Repeater

If you choose Repeater as the connecting mode, please type in the peer MAC address in these fields. Four peer MAC addresses are allowed to be entered in this page at one time. Similarly, if you want to invoke the peer MAC address, remember to check **Enable** box in the front of the MAC address after typing.

Access Point Function

Click **Enable** to make this router serving as an access point; click **Disable** to cancel this function.

Status

It allows user to send "hello" message to peers. Yet, it is valid only when the peer also supports this function.

5.13.7 Advanced Setting

This page allows users to set advanced settings such as operation mode, channel bandwidth, guard interval, and aggregation MSDU for wireless data transmission.

[Wireless LAN >> Advanced Setting](#)

HT Physical Mode

Operation Mode	<input checked="" type="radio"/> Mixed Mode	<input type="radio"/> Green Field
Channel Bandwidth	<input type="radio"/> 20	<input checked="" type="radio"/> 20/40
Guard Interval	<input type="radio"/> long	<input checked="" type="radio"/> auto
Aggregation MSDU(A-MSDU)	<input type="radio"/> Disable	<input checked="" type="radio"/> Enable

OK

Operation Mode

Mixed Mode – the router can transmit data with the ways supported in both 802.11a/b/g and 802.11n standards. However, the entire wireless transmission will be slowed down if 802.11g or 802.11b wireless client is connected.

Green Field – to get the highest throughput, please choose such mode. Such mode can make the data transmission happening between 11n systems only. In addition, it does not have protection mechanism to avoid the conflict with neighboring devices of 802.11a/b/g.

Channel Bandwidth

20 - the router will use 20Mhz for data transmission and receiving between the AP and the stations.

20/40 – the router will use 20Mhz or 40Mhz for data

transmission and receiving according to the station capability. Such channel can increase the performance for data transit.

Guard Interval

It is to assure the safety of propagation delays and reflections for the sensitive digital data. If you choose **auto** as guard interval, the AP router will choose short guard interval (increasing the wireless performance) or long guard interval for data transmit based on the station capability.

Aggregation MSDU

Aggregation MSDU can combine frames with different sizes. It is used for improving MAC layer's performance for some brand's clients. The default setting is **Enable**.

5.13.8 AP Discovery

Vigor router can scan all regulatory channels and find working APs in the neighborhood. Based on the scanning result, users will know which channel is clean for usage. Also, it can be used to facilitate finding an AP for a WDS link. Notice that during the scanning process (about 5 seconds), no client is allowed to connect to Vigor.

This page is used to scan the existence of the APs on the wireless LAN. Yet, only the AP which is in the same channel of this router can be found. Please click **Scan** to discover all the connected APs.

[Wireless LAN >> Access Point Discovery](#)

Access Point List

BSSID	Channel	SSID
-------	---------	------

See [Statistics](#).

Note: During the scanning process (~5 seconds), no station is allowed to connect with the router.

Add to [WDS Settings](#) :

AP's MAC address : : : : :

Bridge Repeater

Scan

It is used to discover all the connected AP. The results will be shown on the box above this button.

Statistics

It displays the statistics for the channels used by APs.

Recommended channels for usage:
1 2 3 4 5 6 7 8 9 10 11 12 13

AP number v.s. Channel

1	2	3	4	5	6	7	8	9	10	11	12	13	14
---	---	---	---	---	---	---	---	---	----	----	----	----	----

Channel

Cancel

Add to

If you want the found AP applying the WDS settings, please type in the AP's MAC address on the bottom of the page or choose the AP MAC address from the Scan result field, and click **Bridge** or **Repeater**. Next, click **Add to**. Later, the MAC address of the AP will be added to Bridge or Repeater field of WDS settings page.

5.13.9 Station List

Station List provides the knowledge of connecting wireless clients now along with its status code. There is a code summary below for explanation. For convenient **Access Control**, you can select a WLAN station and click **Add to Access Control** below.

Station List

Status	MAC Address	Associated with

Refresh

Status Codes :
C: Connected, No encryption.
E: Connected, WEP.
P: Connected, WPA.
A: Connected, WPA2.
B: Blocked by Access Control.
N: Connecting.
F: Fail to pass 802.1X or WPA/PSK authentication.

Note: After a station connects to the router successfully, it may be turned off without notice. In that case, it will still be on the list until the connection expires.

Add to Access Control :

Client's MAC address : : : : :

Add

Refresh

Click this button to refresh the status of station list.

Add

Click this button to add current selected MAC address into **Access Control**.

5.14 USB Application

USB diskette can be regarded as a server. By way of Vigor router, clients on LAN can access, write and read data stored in USB diskette. After setting the configuration in **USB Application**, you can type the IP address of the Vigor router and username/password created in **USB Application>>USB User Management** on the client software. Thus, the client can use the FTP site (USB diskette) or share the Samba service through Vigor router.



5.14.1 USB General Settings

This page will determine the number of concurrent FTP connection, default charset for FTP server and enable Samba service. At present, the Vigor router can support USB diskette with versions of FAT16 and FAT32 only. Therefore, before connecting the USB diskette into the Vigor router, please make sure the memory format for the USB diskette is FAT16 or FAT32. It is recommended for you to use FAT32 for viewing the filename completely (FAT16 cannot support long filename).

[USB Application >> USB General Settings](#)

USB General Settings

General Settings

Simultaneous FTP Connections (Maximum 6)

Default Charset ▼

Samba Service Settings(Network Neighborhood)

Enable Disable

NetBios Name Service

Workgroup Name

Host Name

Note: 1. If Charset is set to "default", only English long file name is supported.
2. Multi-session ftp download will be banned by Router FTP server. If your ftp client have multi-connection mechanism, such as FileZilla, you may limit client connections setting to 1 to get better performance.
3. A workgroup name must not be the same as the host name. The workgroup name and the host name can have as many as 15 characters and a host name can have as many as 23 characters , but both cannot contain any of the following: ; : " < > * + = \ | ?.

General Settings

Simultaneous FTP Connection - This field is used to specify the quantity of the FTP sessions. The router allows up to 6 FTP sessions connecting to USB storage diskette at one time.

Default Charset - At present, Vigor router supports three types of character sets: default, GB2312 and BIG5.

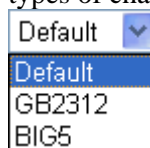

Default Charset is for English based file name. For Simplified Chinese file/directory names, please choose

GB2312; for Traditional Chinese file/directory names, choose BIG5.

Samba Service Settings

Click **Enable** to invoke samba service via the router.

NetBios Name Service

For the NetBios service of USB diskette, you have to specify a workgroup name and a host name. A workgroup name must not be the same as the host name. The workgroup name can have as many as 15 characters and the host name can have as many as 23 characters. Both them cannot contain any of the following-- ; : " < > * + = \ | ?.

Workgroup Name – Type a name for the workgroup.

Host Name – Type the host name for the router.

5.14.2 USB User Management

This page allows you to set profiles for FTP/Samba users. Any user who wants to access into the USB diskette must type the same username and password configured in this page. Before adding or modifying settings in this page, please insert a USB diskette first. Otherwise, an error message will appear to warn you.

[USB Application >> USB User Management](#)

USB User Management			Set to Factory Default		
Index	Username	Home Folder	Index	Username	Home Folder
1.			9.		
2.			10.		
3.			11.		
4.			12.		
5.			13.		
6.			14.		
7.			15.		
8.			16.		

Click index number to access into configuration page.

[USB Application >> USB User Management](#)

Profile Index: 1

FTP/Samba User Enable Disable

Username

Password (Maximum 11 Characters)

Confirm Password

Home Folder 

Access Rule

File Read Write Delete

Directory List Create Remove

Note: The folder name can only contain the following characters: A-Z a-z 0-9 \$ % ' - _ @ ~ ` ! () / and space.

FTP/Samba User

Enable – Click this button to activate this profile (account) for FTP service or Samba User service. Later, the user

can use the username specified in this page to login into FTP server.

Disable – Click this button to disable such profile.

Username

Type the username for FTP/Samba users for accessing into FTP server (USB diskette). Be aware that users cannot access into USB diskette in anonymity. Later, you can open FTP client software and type the username specified here for accessing into USB storage diskette.

Note: “Admin” could not be typed here as username, for the word is specified for accessing into web pages of Vigor router only. Also, it is reserved for FTP firmware upgrade usage.

Password

Type the password for FTP/Samba users for accessing FTP server. Later, you can open FTP client software and type the password specified here for accessing into USB storage diskette.

Confirm Password

Type the password again to make confirmation.

Home Folder

It determines the range for the client to access into.

The user can enter a directory name in this field. Then, after clicking **OK**, the router will create the specific/new folder in the USB diskette. In addition, if the user types “/” here, he/she can access into all of the disk folders and files in USB diskette.

Note: When write protect status for the USB diskette is **ON**, you cannot type any new folder name in this field. Only “/” can be used in such case.

You can click  to open the following dialog to add any new folder which can be specified as the Home Folder.

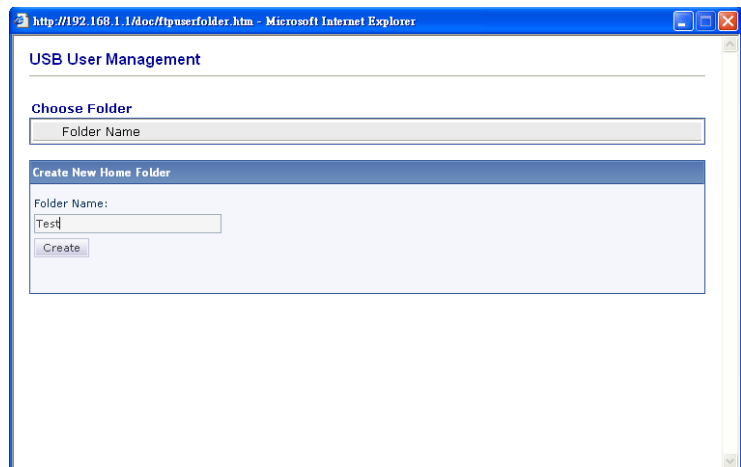

Access Rule

It determines the authority for such profile. Any user, who uses such profile for accessing into USB diskette, must follow the rule specified here.

File – Check the items (Read, Write and Delete) for such profile.

Directory –Check the items (List, Create and Remove) for such profile.

Before you click **OK**, you have to insert a USB diskette into the USB interface of the Vigor router. Otherwise, you cannot save the configuration.

5.14.3 File Explorer

To review the content of USB diskette via USB port of the router, please open USB Application Explorer to browse the files.

[USB Application >> File Explorer](#)

File Explorer

Current Path: /

Name	Size	Delete	Rename
public		✗	
GBK2Uni.dat	128 KB	✗	
Uni2Big.dat	128 KB	✗	
Uni2GBK.dat	128 KB	✗	
MSN_MAIN_0.xml	14 KB	✗	
MSDOS.SYS	1 KB	✗	
NTDETECT.COM	46 KB	✗	
openssl_多CN.zip	585 KB	✗	
SmartStartTime.txt	2 KB	✗	
SmartVPNv350.rar	565 KB	✗	
v2820pbx_g729_sysprompt.ivr	123 KB	✗	
v2820pbx_sysprompt.ivr	978 KB	✗	
BY.rar	5,039 KB	✗	
NewCert222.der	1 KB	✗	
SyslogRC6c.exe	1,252 KB	✗	
SyslogRd.exe	1,252 KB	✗	
SyslogRd1.exe	1,252 KB	✗	
tools_21.6mb.zip	18,223 KB	✗	
sadfsafd.ea	5,430 KB	✗	
bootfont.bin	315 KB	✗	
EConfickerRemover.exe	119 KB	✗	
fat32format.exe	48 KB	✗	
fraggle.exe	18 KB	✗	
fraggle2.exe	18 KB	✗	
GLF1D63.tmp	10 KB	✗	

Upload File

Select a file:

Note: The folder can not be deleted when it is not empty.



Refresh

Click this icon to refresh files list.



Back

Click this icon to return to the upper directory.



Create

Click this icon to add a new folder.

Current Path

Display current folder.

Upload

Click this button to upload the selected file to the USB diskette. The uploaded file in the USB diskette can be shared for other user through FTP.

5.14.4 Disk Status

This page is to monitor the status for the users who accessing into FTP or Samba server (USB diskette) via the Vigor router. If you want to remove the diskette from USB port in router, please click **Disconnect USB Disk** first. And then, remove the USB diskette later.

[USB Application >> USB Disk Status](#)

USB Mass Storage Device Status

Connection Status: Disk Connected	<input type="button" value="Disconnect USB Disk"/>
Write Protect Status: No	
Disk Capacity: 2009 MB	
Free Capacity: 1562 MB Refresh	
FTP & SMB Users Connected Refresh	
Index	Service
	IP Address(Port)
	Username

Note: If the write protect switch of USB disk is turned on, the USB disk is in **READ-ONLY** mode. No data can be written to it.

Connection Status	If there is no USB diskette connected to Vigor router, “ No Disk Connected ” will be shown here.
Write Protect Status	Display current status if such USB disk is protected (data not allowed to be written in) or not.
Disk Capacity	It displays the total capacity of the USB diskette.
Free Capacity	It displays the free space of the USB diskette. Click Refresh at any time to get new status for free capacity.
Index	It displays the number of the client which connecting to FTP server.
Service	It displays the server (FTP or SMB) that the client wants to connect.
IP Address (Port)	It displays the IP address of the user’s host which connecting to the FTP server.
Username	It displays the username that user uses to login to the FTP server.

When you insert USB diskette into the Vigor router, the system will start to find out such device within several seconds.

5.15 System Maintenance

For the system setup, there are several items that you have to know the way of configuration: Status, Administrator Password, Configuration Backup, Syslog, Time setup, Reboot System, and Firmware Upgrade.

Below shows the menu items for System Maintenance.

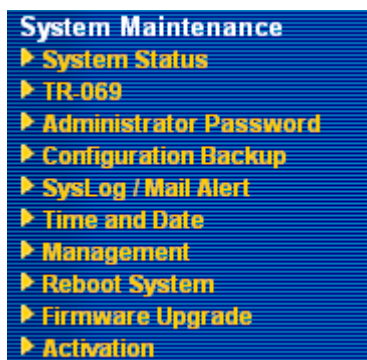

5.15.1 System Status

The **System Status** provides basic network settings of Vigor router. It includes LAN and WAN interface information. Also, you could get the current running firmware version or firmware related information from this presentation.

System Status

Model Name : VigorIPPBX 2820
Firmware Version : 3.5.5_RC3
Build Date/Time : Jun 15 2010 19:00:18
ADSL Firmware Version : 211011_A Hardware: Annex A

LAN	
MAC Address	: 00-50-7F-68-F8-28
1st IP Address	: 192.168.1.1
1st Subnet Mask	: 255.255.255.0
DHCP Server	: Yes
DNS	: 8.8.8.8

WAN 1	
Link Status	: Disconnected
MAC Address	: 00-50-7F-68-F8-29
Connection	: ---
IP Address	: ---
Default Gateway	: ---

SIP Trunk		
Index	Profile	Status
1.	---	---
2.	---	---
3.	---	---
4.	---	---
5.	---	---
6.	---	---

WAN 2	
Link Status	: Connected
MAC Address	: 00-50-7F-68-F8-2A
Connection	: Static IP
IP Address	: 172.16.3.102
Default Gateway	: 172.16.1.1

Wireless LAN	
MAC Address	: 00-50-7F-68-F8-28
Frequency Domain	: Europe
Firmware Version	: 1.8.1.0
SSID	: DrayTek

Model Name	Display the model name of the router.
Firmware Version	Display the firmware version of the router.
Build Date/Time	Display the date and time of the current firmware build.
ADSL Firmware Version	Display the ADSL firmware version.

LAN-----

MAC Address	Display the MAC address of the LAN Interface.
--------------------	---

1st IP Address	Display the IP address of the LAN interface.
1st Subnet Mask	Display the subnet mask address of the LAN interface.
DHCP Server	Display the current status of DHCP server of the LAN interface.
DNS	Display the assigned IP address of the primary DNS.
WAN-----	
Link Status	Display current connection status.
MAC Address	Display the MAC address of the WAN Interface.
Connection	Display the connection type.
IP Address	Display the IP address of the WAN interface.
Default Gateway	Display the assigned IP address of the default gateway.
SIP Trunk-----	
Index/Profile/Status	Display current status for SIP profiles.
Wireless LAN-----	
MAC Address	Display the MAC address of the WLAN Interface.
Frequency Domain	It can be Europe (13 usable channels), USA (11 usable channels) etc. The available channels supported by the wireless products in different countries are various.
Firmware Version	It indicates information about equipped WLAN miniPCi card. This also helps to provide availability of some features that are bound with some WLAN miniPCi.
SSID	Display the SSID of the router.

5.15.2 TR-069

This device supports TR-069 standard. It is very convenient for an administrator to manage a TR-069 device through an Auto Configuration Server, e.g., VigorACS.

[System Maintenance >> TR-069 Setting](#)

ACS and CPE Settings

ACS Server On	Internet ▾
ACS Server	
URL	<input type="text"/>
Username	<input type="text"/>
Password	<input type="password"/>
CPE Client	
<input type="radio"/> Enable	<input checked="" type="radio"/> Disable
URL	<input type="text" value="http://172.16.3.229:8069/cwm/CRN.html"/>
Port	<input type="text" value="8069"/>
Username	<input type="text" value="vigor"/>
Password	<input type="password"/>

Periodic Inform Settings

<input type="radio"/> Disable	<input checked="" type="radio"/> Enable
Interval Time	<input type="text" value="900"/> second(s)

OK

ACS Server On

Choose the interface for the router connecting to ACS server.

ACS Server On

PVC ▾
Internet
PVC

ACS Server

URL/Username/Password – Such data must be typed according to the ACS (Auto Configuration Server) you want to link. Please refer to Auto Configuration Server user's manual for detailed information.

CPE Client

It is not necessary for you to type them. Such information is useful for Auto Configuration Server.

Enable/Disable – Sometimes, port conflict might be occurred. To solve such problem, you might want to change port number for CPE. Please click Enable and change the port number.

Periodic Inform Settings

The default setting is **Enable**. Please set interval time or schedule time for the router to send notification to CPE. Or click **Disable** to close the mechanism of notification.

5.15.3 Administrator Password

This page allows you to set new password.

[System Maintenance >> Administrator Password Setup](#)

Administrator Password

Old Password	<input type="text"/>
New Password	<input type="text"/>
Confirm Password	<input type="text"/>

Old Password Type in the old password. The factory default setting for password is blank.

New Password Type in new password in this field.

Confirm Password Type in the new password again.

When you click OK, the login window will appear. Please use the new password to access into the web configurator again.

5.15.4 Configuration Backup

Backup the Configuration

Follow the steps below to backup your configuration.

4. Go to **System Maintenance >> Configuration Backup**. The following windows will be popped-up, as shown below.

[System Maintenance >> Configuration Backup](#)

Configuration Backup / Restoration

Restoration

Select a configuration file.

Click Restore to upload the file.

Backup

Click Backup to download current running configurations as a file.

5. Click **Backup** button to get into the following dialog. Click **Save** button to open another dialog for saving configuration as a file.

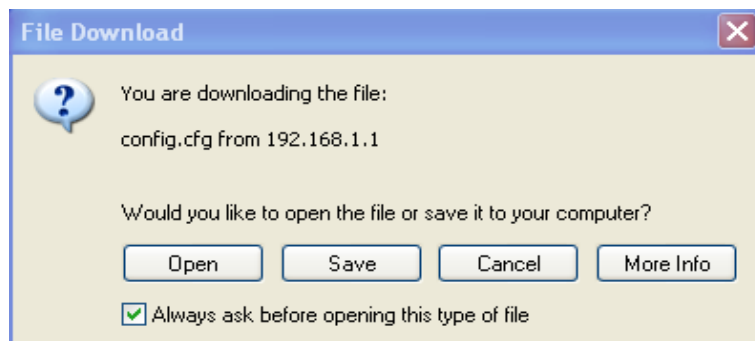

- In **Save As** dialog, the default filename is **config.cfg**. You could give it another name by yourself.

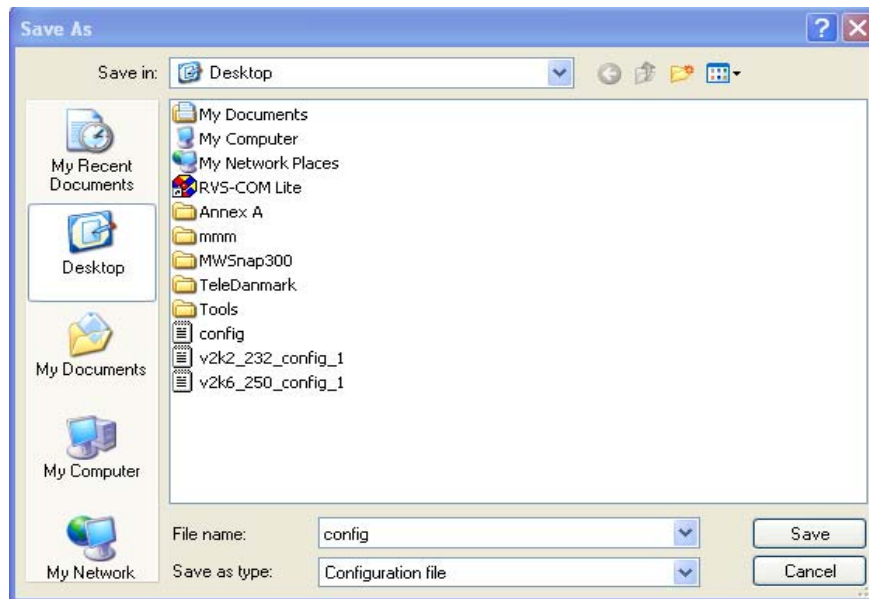

- Click **Save** button, the configuration will download automatically to your computer as a file named **config.cfg**.

The above example is using **Windows** platform for demonstrating examples. The **Mac** or **Linux** platform will appear different windows, but the backup function is still available.

Note: Backup for Certification must be done independently. The Configuration Backup does not include information of Certificate.

Restore Configuration

- Go to **System Maintenance >> Configuration Backup**. The following windows will be popped-up, as shown below.

System Maintenance >> Configuration Backup

Configuration Backup / Restoration

Restoration

Select a configuration file.

Click Restore to upload the file.

Backup

Click Backup to download current running configurations as a file.

- Click **Browse** button to choose the correct configuration file for uploading to the router.
- Click **Restore** button and wait for few seconds, the following picture will tell you that the restoration procedure is successful.

5.15.5 Syslog/Mail Alert

SysLog function is provided for users to monitor router. There is no bother to directly get into the Web Configurator of the router or borrow debug equipments.

[System Maintenance >> SysLog / Mail Alert Setup](#)

SysLog / Mail Alert Setup

<p>SysLog Access Setup</p> <p><input checked="" type="checkbox"/> Enable</p> <p>Syslog Save to:</p> <p><input checked="" type="checkbox"/> Syslog Server</p> <p><input type="checkbox"/> USB Disk</p> <p>Router Name <input style="width: 100%;" type="text"/></p> <p>Server IP Address <input style="width: 100%;" type="text"/></p> <p>Destination Port <input style="width: 50%;" type="text" value="514"/></p> <p>Enable syslog message:</p> <p><input checked="" type="checkbox"/> Firewall Log</p> <p><input checked="" type="checkbox"/> VPN Log</p> <p><input checked="" type="checkbox"/> User Access Log</p> <p><input checked="" type="checkbox"/> Call Log</p> <p><input checked="" type="checkbox"/> WAN Log</p> <p><input checked="" type="checkbox"/> Router/DSL information</p>	<p>Mail Alert Setup</p> <p><input type="checkbox"/> Enable <input style="float: right;" type="button" value="Send a test e-mail"/></p> <p>SMTP Server <input style="width: 100%;" type="text"/></p> <p>Mail To <input style="width: 100%;" type="text"/></p> <p>Return-Path <input style="width: 100%;" type="text"/></p> <p><input type="checkbox"/> Authentication</p> <p>User Name <input style="width: 100%;" type="text"/></p> <p>Password <input style="width: 100%;" type="text"/></p> <p>Enable E-Mail Alert:</p> <p><input checked="" type="checkbox"/> DoS Attack</p> <p><input checked="" type="checkbox"/> IM-P2P</p>
---	--

Enable	Check Enable to activate function of syslog.
Syslog Save to	Check Syslog Server to save the log to Syslog directly. Check USB Disk to save the log to the attached USB diskette.
Router Name	Type in the router name provided by ISP.
Server IP Address	The IP address of the Syslog server.
Destination Port	Assign a port for the Syslog protocol.
Enable syslog message	Check the box listed on this web page to send the corresponding message of firewall, VPN, User Access, Call, WAN, Router/DSL information to Syslog.
Enable (Alert Setup...)	Check Enable to activate function of mail alert.
Send a test e-mail	Make a simple test for the e-mail address specified in this page. Please assign the mail address first and click this button to execute a test for verify the mail address is available or not.
SMTP Server	The IP address of the SMTP server.
Mail To	Assign a mail address for sending mails out.
Return-Path	Assign an e-mail address of another mailbox to accept all returned messages if fatal problems occur at the recipient mailbox. The e-mail address typed here also acts as the Sender address while Vigor sends out the alert e-mails.

- Authentication** Check this box to activate this function while using e-mail application.
- User Name** Type the user name for authentication.
- Password** Type the password for authentication.
- Enable E-mail Alert** Check the box to send alert message to the e-mail box while the modem detecting the item(s) you specify here.
- DoS Attack
 - IM-P2P

Click **OK** to save these settings.

For viewing the Syslog, please do the following:

1. Just set your monitor PC's IP address in the field of Server IP Address
2. Install the Router Tools in the **Utility** within provided CD. After installation, click on the **Router Tools>>Syslog** from program menu.

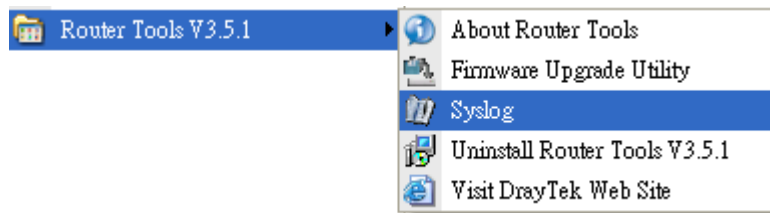

3. From the Syslog screen, select the router you want to monitor. Be reminded that in **Network Information**, select the network adapter used to connect to the router. Otherwise, you won't succeed in retrieving information from the router.

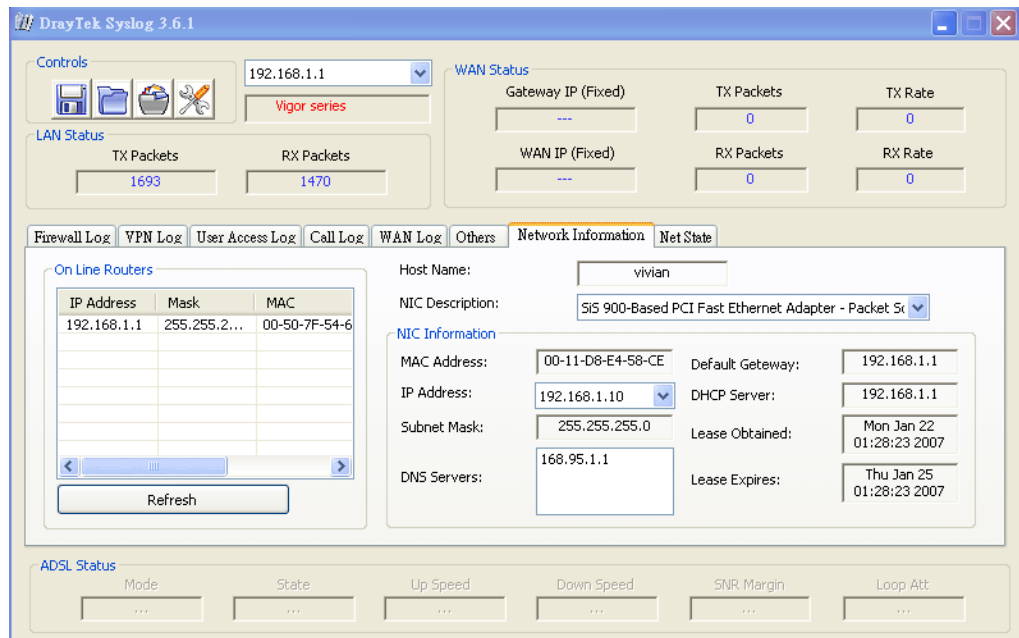

5.15.6 Time and Date

It allows you to specify where the time of the router should be inquired from.

[System Maintenance >> Time and Date](#)

Time Information

Current System Time	2007 Jun 28 Thu 5 : 53 : 42	<input type="button" value="Inquire Time"/>
---------------------	-----------------------------	---

Time Setup

<input type="radio"/> Use Browser Time	
<input checked="" type="radio"/> Use Internet Time Client	
Time Protocol	NTP (RFC-1305) ▼
Server IP Address	pool.ntp.org
Time Zone	(GMT) Greenwich Mean Time : Dublin ▼
Enable Daylight Saving	<input type="checkbox"/>
Automatically Update Interval	30 min ▼

Current System Time

Click **Inquire Time** to get the current time.

Use Browser Time

Select this option to use the browser time from the remote administrator PC host as router's system time.

Use Internet Time

Select to inquire time information from Time Server on the Internet using assigned protocol.

Time Protocol

Select a time protocol.

Server IP Address

Type the IP address of the time server.

Time Zone

Select the time zone where the router is located.

Enable Daylight Saving

Check this box to enable daylight saving. Such function is useful for certain areas.

Automatically Update Interval

Select a time interval for updating from the NTP server.

Click **OK** to save these settings.

5.15.7 Management

This page allows you to manage the settings for access control, access list, port setup, and SMP setup. For example, as to management access control, the port number is used to send/receive SIP message for building a session. The default value is 5060 and this must match with the peer Registrar when making VoIP calls.

[System Maintenance >> Management](#)

Management Setup

Router Name

Management Access Control

Allow management from the Internet

FTP Server

HTTP Server

HTTPS Server

Telnet Server

SSH Server

Disable PING from the Internet

Access List

List	IP	Subnet Mask
1	<input type="text"/>	<input type="text"/>
2	<input type="text"/>	<input type="text"/>
3	<input type="text"/>	<input type="text"/>

Management Port Setup

User Define Ports Default Ports

Telnet Port (Default: 23)

HTTP Port (Default: 80)

HTTPS Port (Default: 443)

FTP Port (Default: 21)

SSH Port (Default: 22)

SNMP Setup

Enable SNMP Agent

Get Community

Set Community

Manager Host IP

Trap Community

Notification Host IP

Trap Timeout seconds

Router Name

Type in the router name provided by ISP.

Allow management from the Internet

Enable the checkbox to allow system administrators to login from the Internet. There are several servers provided by the system to allow you managing the router from Internet. Check the box(es) to specify.

Disable PING from the Internet

Check the checkbox to reject all PING packets from the Internet. For security issue, this function is enabled by default.

Access List

You could specify that the system administrator can only login from a specific host or network defined in the list. A maximum of three IPs/subnet masks is allowed.

List IP - Indicate an IP address allowed to login to the router.

Subnet Mask - Represent a subnet mask allowed to login to the router.

Default Ports

Check to use standard port numbers for the Telnet and HTTP servers.

User Defined Ports

Check to specify user-defined port numbers for the Telnet, HTTP and FTP servers.

Enable SNMP Agent

Check it to enable this function.

Get Community	Set the name for getting community by typing a proper character. The default setting is public .
Set Community	Set community by typing a proper name. The default setting is private .
Manager Host IP	Set one host as the manager to execute SNMP function. Please type in IP address to specify certain host.
Trap Community	Set trap community by typing a proper name. The default setting is public .
Notification Host IP	Set the IP address of the host that will receive the trap community.
Trap Timeout	The default setting is 10 seconds.

5.15.8 Reboot System

The Web Configurator may be used to restart your router. Click **Reboot System** from **System Maintenance** to open the following page.

[System Maintenance >> Reboot System](#)

Reboot System

Do you want to reboot your router ?

Using current configuration
 Using factory default configuration

Auto Reboot Time Schedule

Index(1-15) in [Schedule](#) Setup: , , ,

Note: Action and Idle Timeout settings will be ignored.

Index (1-15) in Schedule Setup - You can type in four sets of time schedule for performing system reboot. All the schedules can be set previously in **Applications >> Schedule** web page and you can use the number that you have set in that web page.

If you want to reboot the router using the current configuration, check **Using current configuration** and click **OK**. To reset the router settings to default values, check **Using factory default configuration** and click **OK**. The router will take 5 seconds to reboot the system.

Note: When the system pops up Reboot System web page after you configure web settings, please click **OK** to reboot your router for ensuring normal operation and preventing unexpected errors of the router in the future.

5.15.9 Firmware Upgrade

Before upgrading your router firmware, you need to install the Router Tools. The **Firmware Upgrade Utility** is included in the tools. The following web page will guide you to upgrade firmware by using an example. Note that this example is running over Windows OS (Operating System).

Download the newest firmware from DrayTek's web site or FTP site. The DrayTek web site is www.draytek.com (or local DrayTek's web site) and FTP site is <ftp.draytek.com>.

Click **System Maintenance>> Firmware Upgrade** to launch the Firmware Upgrade Utility.

System Maintenance >> Firmware Upgrade

Web Firmware Upgrade

Select a firmware file.

Click Upgrade to upload the file.

TFTP Firmware Upgrade from LAN

Current Firmware Version: 3.5.5_RC3

Firmware Upgrade Procedures:

1. Click "OK" to start the TFTP server.
2. Open the Firmware Upgrade Utility or other 3-party TFTP client software.
3. Check that the firmware filename is correct.
4. Click "Upgrade" on the Firmware Upgrade Utility to start the upgrade.
5. After the upgrade is complete, the TFTP server will automatically stop running.

Do you want to upgrade firmware ?

Click **OK**. The following screen will appear. Please execute the firmware upgrade utility first.

System Maintenance >> Firmware Upgrade

 TFTP server is running. Please execute a Firmware Upgrade Utility software to upgrade router's firmware. This server will be closed by itself when the firmware upgrading finished.

5.15.10 Activation

There are three ways to activate WCF on vigor router, using **Service Activation Wizard**, by means of **CSM>>Web Content Filter Profile** or via **System Maintenance>>Activation**.

After you have finished the setting profiles for WCF, it is the time to activate the mechanism for your computer.

Click **System Maintenance>>Activation** to open the following page for accessing <http://myvigor.draytek.com>.

Web-Filter License

[Activate](#)

[Status:Not Activated]

Authentication Message

Note: If you want to use email alert or syslog, please configure the [SysLog/Mail Alert Setup](#) page.
 If you change the service provider, the configuration of the function will be reset.

OK Cancel

Activate via Interface

Choose WAN interface used by such device for activating Web Content Filter.

Activate via interface : WAN 1

auto-selected
WAN 1
 WAN 2

Activate

The **Activate** link brings you accessing into www.vigorpro.com to finish the activation of the account and the router.

Authentication Message

As for authentication information of **web filter**, the process of authenticating will be displayed on this field for your reference.

Below shows the successful activation of Web Content Filter:

Web-Filter License

[Activate](#)

[Status:CT-CF] [Start Date:2010-03-15 Expire Date:2010-04-15]

Authentication Message

Activated Wiz, Activated Wizard query license status Successful, 2010-03-15 07:28:20

Note: If you want to use email alert or syslog, please configure the [SysLog/Mail Alert Setup](#) page.
 If you change the service provider, the configuration of the function will be reset.

OK Cancel

Status

Display the mechanism (represented with code number, e.g.,

CT-CF) adopted by such router.

Start Date	Display the starting date of WCF license activated successfully.
Expire Date	Display the ending date of WCF license activated successfully.
Activate	Click this link to access into http://myvigor.draytek.com for activating WCF function.

5.16 Diagnostics

Diagnostic Tools provide a useful way to **view** or **diagnose** the status of your Vigor router.

Below shows the menu items for Diagnostics.



5.16.1 Dial-out Trigger

Click **Diagnostics** and click **Dial-out Trigger** to open the web page. The internet connection (e.g., ISDN, PPPoE, PPPoA, etc) is triggered by a package sending from the source IP address.

[Diagnostics >> Dial-out Trigger](#)

Dial-out Triggered Packet Header | [Refresh](#) |

HEX Format:

```
00 50 7F 00 00 00-00 0E A6 2A D5 A1-08 00

45 00 00 30 89 C9 40 00-7F 06 80 01 C0 A8 01 0A
41 36 EF 14 08 A4 07 47-33 20 94 D1 00 00 00 00
70 02 FF FF B9 45 00 00-02 04 05 B4 01 01 04 02
BE 9C 80 C9 9F A8 80 5B-3D D9 80 19 84 68 00 00
00 00 00 00 00 00 00 00-00 00 00 00 00 00 00
```

Decoded Format:

```
192.168.1.10,2212 -> 65.54.239.20,1863
Pr tcp HLen 20 TLen 48 -S Seq 857773265 Ack 0 Win 65535
```

Decoded Format

It shows the source IP address (local), destination IP (remote) address, the protocol and length of the package.

Refresh

Click it to reload the page.

5.16.2 Routing Table

Click **Diagnostics** and click **Routing Table** to open the web page.

[Diagnostics >> View Routing Table](#)

Current Running Routing Table | [Refresh](#)

```
Key: C - connected, S - static, R - RIP, * - default, ~ - private
*          0.0.0.0/          0.0.0.0 via 172.16.3.4,    WAN2
C~        192.168.1.0/      255.255.255.0 is directly connected,  LAN
C         172.16.0.0/       255.255.0.0 is directly connected,   WAN2
```

Refresh

Click it to reload the page.

5.16.3 ARP Cache Table

Click **Diagnostics** and click **ARP Cache Table** to view the content of the ARP (Address Resolution Protocol) cache held in the router. The table shows a mapping between an Ethernet hardware address (MAC Address) and an IP address.

[Diagnostics >> View ARP Cache Table](#)

Ethernet ARP Cache Table | [Clear](#) | [Refresh](#)

IP Address	MAC Address
192.168.1.10	00-0E-A6-2A-D5-A1
172.16.2.240	00-05-5D-04-D2-C0
172.16.2.194	00-50-7F-33-31-E9
172.16.3.237	00-0C-6E-00-CA-63
172.16.3.222	00-50-7F-1A-59-11
172.16.2.209	00-07-40-82-13-77
172.16.3.181	00-50-7F-1A-58-CF
172.16.2.238	00-50-7F-C0-29-1D
172.16.2.62	00-50-7F-28-6E-21
172.16.3.201	00-50-7F-1C-49-E5
220.130.52.220	00-50-7F-C1-06-4D
172.16.3.115	00-1A-92-92-E8-1D
172.16.2.114	00-50-7F-C0-25-BD
172.16.3.134	00-50-7F-33-31-E3
172.16.2.229	00-50-7F-F0-00-5E

Refresh

Click it to reload the page.

Clear

Click it to clear the whole table.

5.16.4 DHCP Table

The facility provides information on IP address assignments. This information is helpful in diagnosing network problems, such as IP address conflicts, etc.

Click **Diagnostics** and click **DHCP Table** to open the web page.

[Diagnostics >> View DHCP Assigned IP Addresses](#)

Index	IP Address	MAC Address	Leased Time	HOST ID
1	192.168.1.10	00-0E-A6-2A-D5-A1	0:00:06.820	ok-lccgjyiy075u

Index	It displays the connection item number.
IP Address	It displays the IP address assigned by this router for specified PC.
MAC Address	It displays the MAC address for the specified PC that DHCP assigned IP address for it.
Leased Time	It displays the leased time of the specified PC.
HOST ID	It displays the host ID name of the specified PC.
Refresh	Click it to reload the page.

5.16.5 NAT Sessions Table

Click **Diagnostics** and click **NAT Sessions Table** to open the setup page.

[Diagnostics >> NAT Sessions Table](#)

Private IP :Port	#Pseudo Port	Peer IP :Port	Interface
192.168.1.10 2473	52059	207.46.106.51 1863	WAN2
192.168.1.10 2476	52062	207.46.26.253 7001	WAN2
192.168.1.10 2477	52063	207.46.26.254 7001	WAN2
192.168.1.10 2477	52063	207.46.26.254 9	WAN2
192.168.1.10 2477	52063	207.46.26.253 7001	WAN2
192.168.1.10 2478	52064	207.68.178.16 80	WAN2
192.168.1.10 2479	52065	207.68.178.16 80	WAN2

Private IP:Port	It indicates the source IP address and port of local PC.
------------------------	--

#Pseudo Port	It indicates the temporary port of the router used for NAT.
Peer IP:Port	It indicates the destination IP address and port of remote host.
Interface	It displays the representing number for different interface.
Refresh	Click it to reload the page.

5.16.6 Ping Diagnosis

Click **Diagnostics** and click **Ping Diagnosis** to pen the web page.

[Diagnostics >> Ping Diagnosis](#)

Ping Diagnosis

Note: If you want to ping a LAN PC or you don't want to specify which WAN to ping through, please select "Unspecified".

Ping through:

Ping to: IP Address:

Result

Ping through Use the drop down list to choose the WAN interface that you want to ping through or choose **Unspecified** to be determined by the router automatically.

Ping through:

Unspecified

WAN1

WAN2

Ping to Use the drop down list to choose the destination that you want to ping.

IP Address Type in the IP address of the Host/IP that you want to ping.

Run Click this button to start the ping work. The result will be displayed on the screen.

Clear Click this link to remove the result on the window.

5.16.7 Data Flow Monitor

This page displays the running procedure for the IP address monitored and refreshes the data in an interval of several seconds. The IP address listed here is configured in Bandwidth Management. You have to enable IP bandwidth limit and IP session limit before invoke Data Flow Monitor. If not, a notification dialog box will appear to remind you enabling it.

Click **Diagnostics** and click **Data Flow Monitor** to open the web page. You can click **IP Address**, **TX rate**, **RX rate** or **Session** link for arranging the data display.

[Diagnostics >> Data Flow Monitor](#)

[Enable Data Flow Monitor](#)

Refresh Seconds: Page: | [Refresh](#) |

Index	IP Address	TX rate(Kbps)	RX rate(Kbps)	Sessions	Action
		Current / Peak / Speed	Current / Peak / Speed	Current / Peak	
WAN1	---	0 / 0 / Auto	0 / 0 / Auto	---	
WAN2	192.168.5.20	1 / 1401 / Auto	1 / 2124 / Auto	---	
Total		1 / 1401 / Auto	1 / 2124 / Auto	9 / 85	

Note: 1. Click "Block" to prevent specified PC from surfing Internet for 5 minutes.
 2. The IP blocked by the router will be shown in red, and the session column will display the remaining time that the specified IP will be blocked.
 3. (Kbps): shared bandwidth
 + : residual bandwidth used
 Current/Peak are average.

Enable Data Flow Monitor Check this box to enable this function.

Refresh Seconds Use the drop down list to choose the time interval of refreshing data flow that will be done by the system automatically.

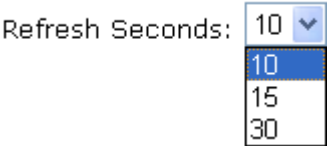

Refresh Click this link to refresh this page manually.

Index Display the number of the data flow.

IP Address Display the IP address of the monitored device.

TX rate (kbps) Display the transmission speed of the monitored device.

RX rate (kbps) Display the receiving speed of the monitored device.

Sessions Display the session number that you specified in Limit Session web page.

Action

Block - can prevent specified PC accessing into Internet within 5 minutes.

Page: 1 | Refresh

IP(s)	Sessions	Action
	7	Block

Unblock – the device with the IP address will be blocked in five minutes. The remaining time will be shown on the session column.

Page: 1 | Refresh

IP(s)	Sessions	Action
	blocked / 298	Unblock

5.16.8 Traffic Graph

Click **Diagnostics** and click **Traffic Graph** to pen the web page. Choose WAN1 Bandwidth/WAN2 Bandwidth, Sessions, daily or weekly for viewing different traffic graph. Click **Refresh** to renew the graph at any time.

[Diagnostics >> Traffic Graph](#)

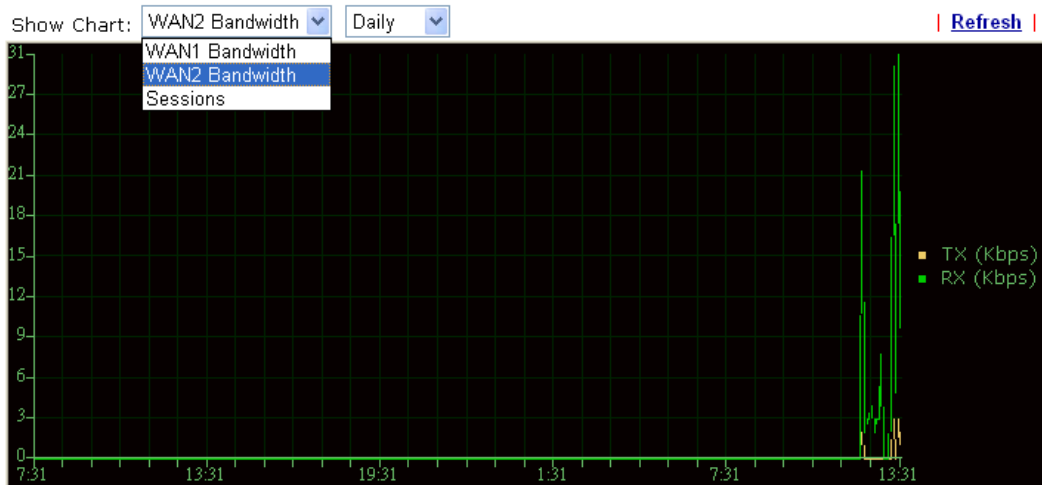

5.16.9 Trace Route

Click **Diagnostics** and click **Trace Route** to open the web page. This page allows you to trace the routes from router to the host. Simply type the IP address of the host in the box and click **Run**. The result of route trace will be shown on the screen.

[Diagnostics >> Trace Route](#)

Trace Route

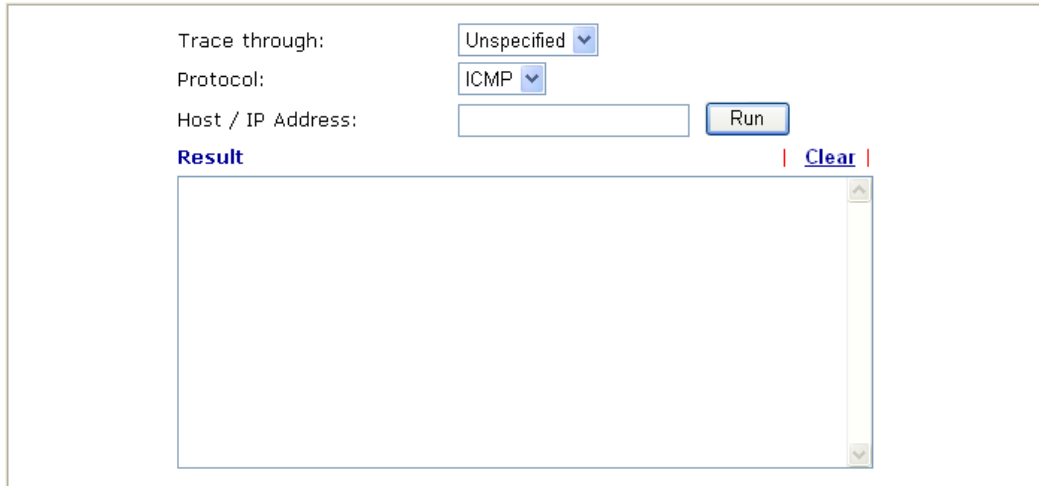

Trace through

Use the drop down list to choose the WAN interface that you want to ping through or choose **Unspecified** to be determined by the router automatically.

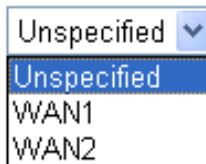

Protocol

Choose a protocol (ICMP or UDP) for such route.

Host/IP Address

It indicates the IP address of the host.

Run

Click this button to start route tracing work.

Clear

Click this link to remove the result on the window.

This page is left blank.

Chapter 6: Trouble Shooting

This section will guide you to solve abnormal situations if you cannot access into the Internet after installing the router and finishing the web configuration. Please follow sections below to check your basic installation status stage by stage.

- Checking if the hardware status is OK or not.
- Checking if the network connection settings on your computer are OK or not.
- Pinging the router from your computer.
- Checking if the ISP settings are OK or not.
- Backing to factory default setting if necessary.

If all above stages are done and the router still cannot run normally, it is the time for you to contact your dealer for advanced help.

6.1 Checking If the Hardware Status Is OK or Not

Follow the steps below to verify the hardware status.

1. Check the power line and WLAN/LAN cable connections. Refer to “**1.3 Hardware Installation**” for details.
2. Turn on the router. Make sure the **ACT LED** blink once per second and the correspondent **LAN LED** is bright.

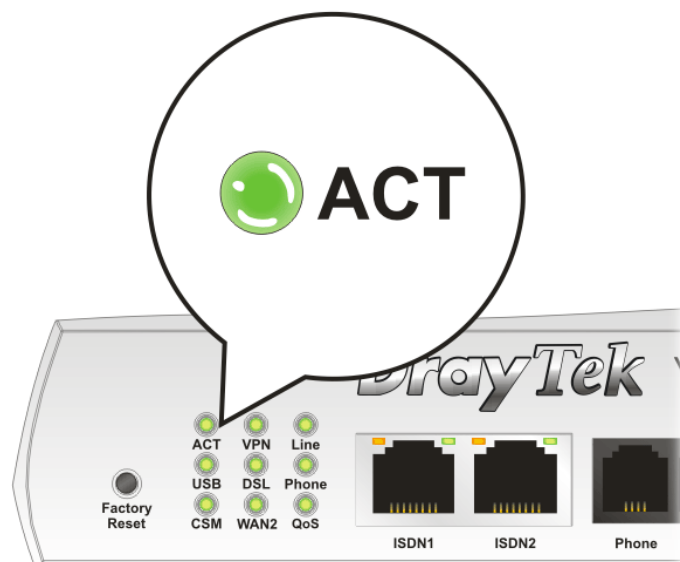

3. If not, it means that there is something wrong with the hardware status. Simply back to “**1.3 Hardware Installation**” to execute the hardware installation again. And then, try again.

6.2 Checking If the Network Connection Settings on Your Computer Is OK or Not

Sometimes the link failure occurs due to the wrong network connection settings. After trying the above section, if the link is still failed, please do the steps listed below to make sure the network connection settings is OK.

For Windows



The example is based on Windows XP. As to the examples for other operation systems, please refer to the similar steps or find support notes in www.draytek.com.

1. Go to **Control Panel** and then double-click on **Network Connections**.



2. Right-click on **Local Area Connection** and click on **Properties**.

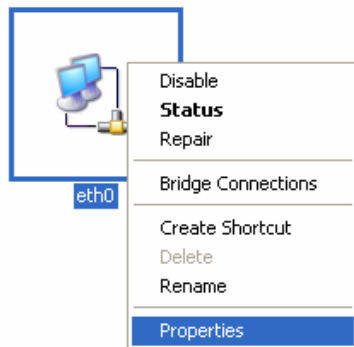

3. Select **Internet Protocol (TCP/IP)** and then click **Properties**.

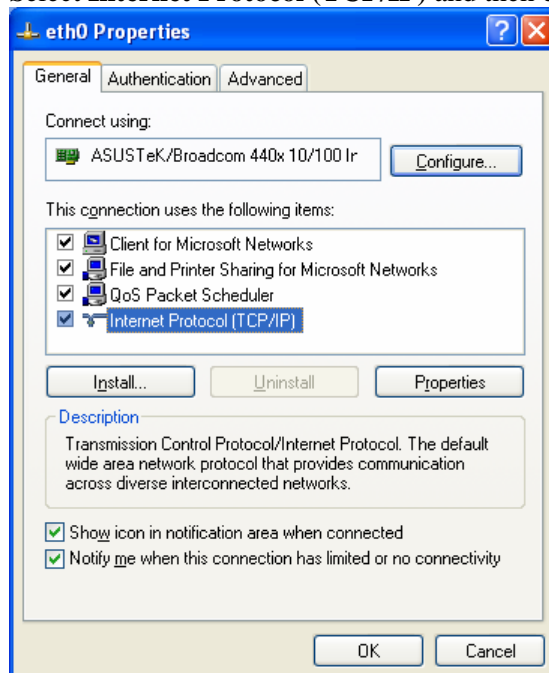

4. Select **Obtain an IP address automatically** and **Obtain DNS server address automatically**.

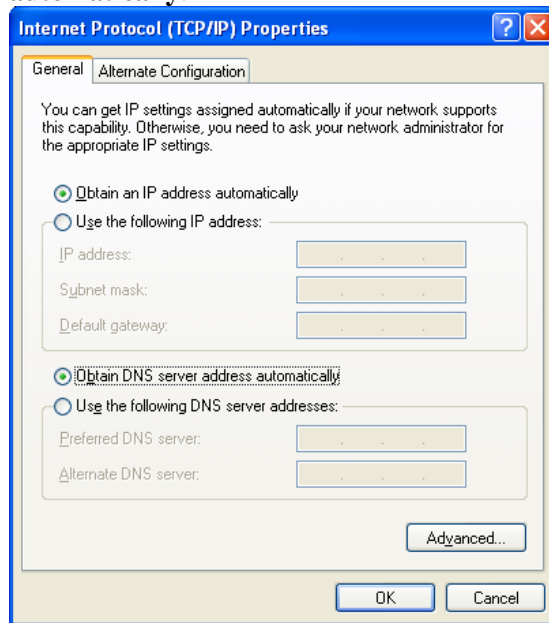

For MacOs

1. Double click on the current used MacOs on the desktop.
2. Open the **Application** folder and get into **Network**.
3. On the **Network** screen, select **Using DHCP** from the drop down list of Configure IPv4.

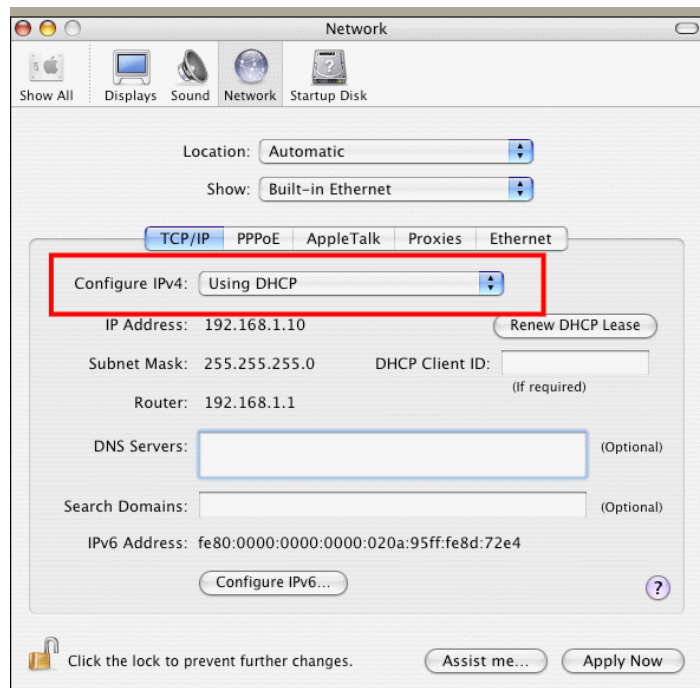

6.3 Pinging the Router from Your Computer

The default gateway IP address of the router is 192.168.1.1. For some reason, you might need to use “ping” command to check the link status of the router. **The most important thing is that the computer will receive a reply from 192.168.1.1.** If not, please check the IP address of your computer. We suggest you setting the network connection as **get IP automatically**. (Please refer to the section 6.2)

Please follow the steps below to ping the router correctly.

For Windows

1. Open the **Command Prompt** window (from **Start menu> Run**).
2. Type **command** (for Windows 95/98/ME) or **cmd** (for Windows NT/ 2000/XP/Vista). The DOS command dialog will appear.

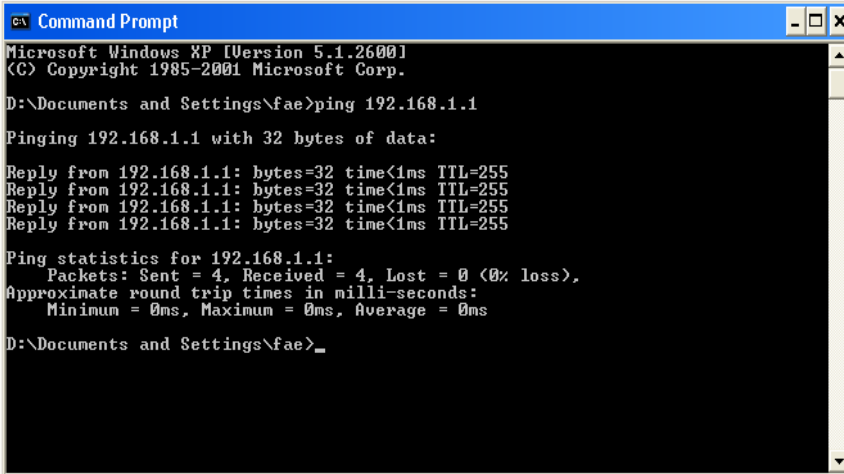

```
Microsoft Windows XP [Version 5.1.2600]
(C) Copyright 1985-2001 Microsoft Corp.

D:\Documents and Settings\fae>ping 192.168.1.1

Pinging 192.168.1.1 with 32 bytes of data:

Reply from 192.168.1.1: bytes=32 time<1ms TTL=255
Reply from 192.168.1.1: bytes=32 time<1ms TTL=255
Reply from 192.168.1.1: bytes=32 time<1ms TTL=255
Reply from 192.168.1.1: bytes=32 time<1ms TTL=255

Ping statistics for 192.168.1.1:
    Packets: Sent = 4, Received = 4, Lost = 0 (0% loss),
    Approximate round trip times in milli-seconds:
        Minimum = 0ms, Maximum = 0ms, Average = 0ms

D:\Documents and Settings\fae>_
```

3. Type ping 192.168.1.1 and press [Enter]. If the link is OK, the line of “**Reply from 192.168.1.1:bytes=32 time<1ms TTL=255**” will appear.
4. If the line does not appear, please check the IP address setting of your computer.

For MacOs (Terminal)

1. Double click on the current used MacOs on the desktop.
2. Open the **Application** folder and get into **Utilities**.
3. Double click **Terminal**. The Terminal window will appear.
4. Type **ping 192.168.1.1** and press [Enter]. If the link is OK, the line of “**64 bytes from 192.168.1.1: icmp_seq=0 ttl=255 time=xxxx ms**” will appear.

```
Terminal — bash — 80x24
Last login: Sat Jan  3 02:24:18 on ttys1
Welcome to Darwin!
Vigor10:~ draytek$ ping 192.168.1.1
PING 192.168.1.1 (192.168.1.1): 56 data bytes
64 bytes from 192.168.1.1: icmp_seq=0 ttl=255 time=0.755 ms
64 bytes from 192.168.1.1: icmp_seq=1 ttl=255 time=0.697 ms
64 bytes from 192.168.1.1: icmp_seq=2 ttl=255 time=0.716 ms
64 bytes from 192.168.1.1: icmp_seq=3 ttl=255 time=0.731 ms
64 bytes from 192.168.1.1: icmp_seq=4 ttl=255 time=0.72 ms
^C
--- 192.168.1.1 ping statistics ---
5 packets transmitted, 5 packets received, 0% packet loss
round-trip min/avg/max = 0.697/0.723/0.755 ms
Vigor10:~ draytek$
```

6.4 Checking If the ISP Settings are OK or Not

Click **WAN>> Internet Access** and then check whether the ISP settings are set correctly. Click WAN1 or WAN2 link to review the settings that you configured previously.

[WAN >> Internet Access](#)

Internet Access

Index	Display Name	Physical Mode	Config Information
WAN1		ADSL	Channel: 1, VPI: 0, VCI: 33, Protocol: PPPoE/LLC/SNAP, Modulation: Multimode, Dynamic IP
WAN2		Ethernet	IP Address: 172.16.3.229, Subnet Mask: 255.255.0.0, Gateway IP: 172.16.3.4

For PPPoE Users

1. Check if the **Enable** option is selected.
2. Check if **Username** and **Password** are entered with correct values that you **got from** your **ISP**.

[WAN >> Internet Access](#)

WAN 1

PPPoE / PPPoA	MPoA (RFC1483/2684)
<input checked="" type="radio"/> Enable <input type="radio"/> Disable	
DSL Modem Settings Multi-PVC channel: Channel 1 VPI: 8 VCI: 35 Encapsulating Type: VC MUX Protocol: PPPoA Modulation: Multimode	
PPPoE Pass-through <input type="checkbox"/> For Wired LAN <input type="checkbox"/> For Wireless LAN	
ISDN Dial Backup Setup Dial Backup Mode: None	
WAN Connection Detection Mode: ARP Detect Ping IP: TTL:	
ISP Access Setup Username: Password: PPP Authentication: PAP or CHAP Idle Timeout: -1 second(s) IP Address From ISP <input type="button" value="WAN IP Alias"/> <input type="radio"/> Fixed IP Yes <input checked="" type="radio"/> No (Dynamic IP) Fixed IP Address:	
<input checked="" type="radio"/> Default MAC Address <input type="radio"/> Specify a MAC Address MAC Address: 00 . 50 . 7F . 94 . E7 . 81	
Index(1-15) in Schedule Setup: => , , ,	

For MPoA Users

1. Check if the **Enable** option is selected.

WAN 1

PPPoE / PPPoA | **MPoA (RFC1483/2684)**

Enable Disable

WAN IP Network Settings WAN IP Alias

Obtain an IP address automatically

Router Name *

Domain Name *

* : Required for some ISPs

Specify an IP address

IP Address

Subnet Mask

Gateway IP Address

Default MAC Address

Specify a MAC Address

MAC Address:

DNS Server IP Address

Primary IP Address

Secondary IP Address

DSL Modem Settings

Multi-PVC channel

Encapsulation

VPI

VCI

Modulation

ISDN Dial Backup Setup

Dial Backup Mode

WAN Connection Detection

Mode

Ping IP

TTL:

RIP Protocol

Enable RIP

Bridge Mode

Enable Bridge Mode

OK Cancel

2. Check if **DSL Modem Settings** is set appropriately.

Check if **IP Address**, **Subnet Mask** and **Gateway** are set correctly (must identify with the values from your ISP) if you choose **Specify an IP address**.

For Static/Dynamic IP Users

1. Check if the **Enable** option is selected.
2. Check if **IP address, Subnet Mask** and **Gateway** are entered with correct values that you **got from your ISP**.

[WAN >> Internet Access](#)

WAN 2

PPPoE	Static or Dynamic IP	PPTP/L2TP
<input checked="" type="radio"/> Enable <input type="radio"/> Disable		WAN IP Network Settings WAN IP Alias
ISDN Dial Backup Setup Dial Backup Mode: <input type="text" value="None"/>		<input type="radio"/> Obtain an IP address automatically Router Name: <input type="text"/> * Domain Name: <input type="text"/> * <small>* : Required for some ISPs</small>
Keep WAN Connection <input type="checkbox"/> Enable PING to keep alive PING to the IP: <input type="text"/> PING Interval: <input type="text" value="0"/> minute(s)		<input checked="" type="radio"/> Specify an IP address IP Address: <input type="text" value="172.16.3.229"/> Subnet Mask: <input type="text" value="255.255.0.0"/> Gateway IP Address: <input type="text" value="172.16.3.4"/>
WAN Connection Detection Mode: <input type="text" value="ARP Detect"/> Ping IP: <input type="text"/> TTL: <input type="text"/>		<input checked="" type="radio"/> Default MAC Address <input type="radio"/> Specify a MAC Address MAC Address: <input type="text" value="00"/> <input type="text" value="50"/> <input type="text" value="7F"/> <input type="text" value="94"/> <input type="text" value="F7"/> <input type="text" value="82"/>
RIP Protocol <input type="checkbox"/> Enable RIP		DNS Server IP Address Primary IP Address: <input type="text"/> Secondary IP Address: <input type="text"/>
<input type="button" value="OK"/> <input type="button" value="Cancel"/>		

For PPTP Users

1. Check if the **Enable** option for **PPTP Link** is selected.

[WAN >> Internet Access](#)

WAN 2

PPPoE	Static or Dynamic IP	PPTP/L2TP
<input type="radio"/> Enable PPTP <input type="radio"/> Enable L2TP <input checked="" type="radio"/> Disable		PPP Setup PPP Authentication: <input type="text" value="PAP or CHAP"/> Idle Timeout: <input type="text" value="-1"/> second(s)
Server Address: <input type="text"/> Specify Gateway IP Address: <input type="text"/>		IP Address Assignment Method (IPCP) WAN IP Alias Fixed IP: <input type="radio"/> Yes <input checked="" type="radio"/> No (Dynamic IP) Fixed IP Address: <input type="text"/>
ISP Access Setup Username: <input type="text"/> Password: <input type="text"/> Index(1-15) in Schedule Setup: => <input type="text"/> , <input type="text"/> , <input type="text"/> , <input type="text"/>		WAN IP Network Settings <input checked="" type="radio"/> Obtain an IP address automatically <input type="radio"/> Specify an IP address IP Address: <input type="text"/> Subnet Mask: <input type="text"/>
ISDN Dial Backup Setup Dial Backup Mode: <input type="text" value="None"/>		
<input type="button" value="OK"/> <input type="button" value="Cancel"/>		

2. Check if **PPTP Server, Username, Password** and **WAN IP address** are set correctly (must identify with the values from your ISP).

6.5 Problems for 3G Network Connection

When you have trouble in using 3G network transmission, please check the following:

Check if USB LED lights on or off

You have to wait about 15 seconds after inserting 3G USB Modem into your Vigor2820. Later, the USB LED will light on which means the installation of USB Modem is successful. If the USB LED does not light on, please remove and reinsert the modem again. If it still fails, restart Vigor2820.

USB LED lights on but the network connection does not work

Check the PIN Code of SIM card is disabled or not. Please use the utility of 3G USB Modem to disable PIN code and try again. If it still fails, it might be the compliance problem of system. Please open DrayTek Syslog Tool to capture the connection information (WAN Log) and send the page (similar to the following graphic) to the service center of DrayTek.

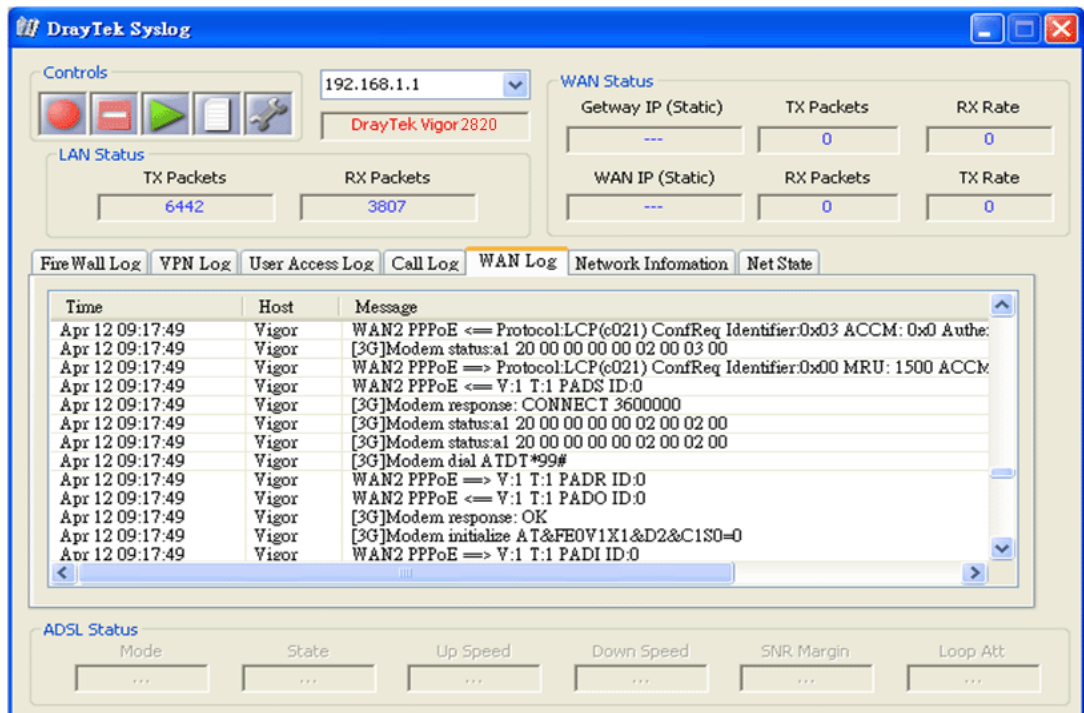

Transmission Rate is not fast enough

Please connect your Notebook with 3G USB Modem to test the connection speed to verify if the problem is caused by VigorIPPBX 2820. In addition, please refer to the manual of 3G USB Modem for LED Status to make sure if the modem connects to Internet via HSDPA mode. If you want to use the modem indoors, please put it on the place near the window to obtain better signal receiving.

6.6 Backing to Factory Default Setting If Necessary

Sometimes, a wrong connection can be improved by returning to the default settings. Try to reset the router by software or hardware.



Warning: After pressing **factory default setting**, you will lose all settings you did before. Make sure you have recorded all useful settings before you pressing. The password of factory default is null.

Software Reset

You can reset the router to factory default via Web page.

Go to **System Maintenance** and choose **Reboot System** on the web page. The following screen will appear. Choose **Using factory default configuration** and click **OK**. After few seconds, the router will return all the settings to the factory settings.

[System Maintenance >> Reboot System](#)

Reboot System

Do you want to reboot your router ?

- Using current configuration
- Using factory default configuration

OK

Hardware Reset

While the router is running (ACT LED blinking), press the **Factory Reset** button and hold for more than 5 seconds. When you see the **ACT** LED blinks rapidly, please release the button. Then, the router will restart with the default configuration.

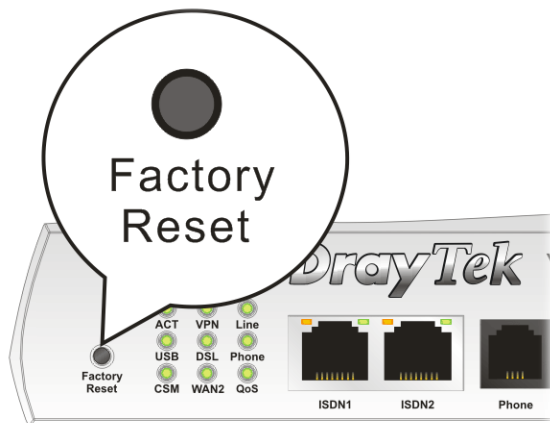

After restore the factory default setting, you can configure the settings for the router again to fit your personal request.

6.7 Contacting Your Dealer

If the router still cannot work correctly after trying many efforts, please contact your dealer for further help right away. For any questions, please feel free to send e-mail to support@draytek.com.

Appendix: Hardware Specifications

Temperature	Operating : 0°C ~ 45°C
	Storage : -25°C ~ 70°C
Humidity	10% ~ 90% (non-condensing)
Max. Power Consumption	10 Watt
Dimension	L241 * W165 * H44 (mm)
Power	DC 12V ~ 15V