

Megapixel
1280 x 960
software zoom

30 Frames/s
VGA (640 x 480)
10 F/s Mega

-22° F ... +140° F

Weatherproof
- 30° ... +60° C, IP65
no heating necessary

IEEE 802.3af

PoE

network power
even in winter

microphone & speaker

Audio

bi-directional via IP
variable framerates

SIP-Client with video

IP-Telephony
alarm notify,
cam remote control

Video motion

multiple windows
precision pixel-based

lip-synchronized audio

Recording

event-ringbuffer
30 cams each 30 F/s

Live viewing

30 cams at 30 F/s
all on one screen

Backlight

safe using CMOS
without mechanical iris

Wall bracket

with cable cover
for RJ45 wall outlet

Robust

no moving parts
fiber glass housing

Security-Vision-Systems



MOBOTIX

MOBOTIX ... the intelligent & efficient way to record video!

2006 October 26th

Dr. Ralf Hinkel • CEO and founder of MOBOTIX



Megapixel
1280 x 960
software zoom

30 Frames/s
VGA (640 x 480)
10 F/s Mega

-22° F ... +140° F

Weatherproof
-30° ... +60° C, IP65
no heating necessary

IEEE 802.3af

PoE

network power
even in winter

microphone & speaker

Audio

bi-directional via IP
variable framerates

SIP-Client with video

IP-Telephony

alarm notify,
cam remote control

Video motion

multiple windows
precision pixel-based

lip-synchronized audio

Recording

event-ringbuffer
30 cams each 30 F/s

Live viewing

30 cams at 30 F/s
all on one screen

Backlight

safe using CMOS
without mechanical iris

Wall bracket

with cable cover
for RJ45 wall outlet

Robust

no moving parts
fiber glass housing

Security-Vision-Systems



MOBOTIX AG • Security Vision Systems • Made in Germany • www.mobotix.com



Megapixel
1280 x 960
software zoom

30 Frames/s
VGA (640 x 480)
10 F/s Mega

-22° F ... +140° F

Weatherproof
-30° ... +60° C, IP65
no heating necessary

IEEE 802.3af

PoE

network power
even in winter

microphone & speaker

Audio

bi-directional via IP
variable framerates

SIP-Client with video

IP-Telephony

alarm notify,
cam remote control

Video motion

multiple windows
precision pixel-based

lip-synchronized audio

Recording

event-ringbuffer
30 cams each 30 F/s

Live viewing

30 cams at 30 F/s
all on one screen

Backlight

safe using CMOS
without mechanical iris

Wall bracket

with cable cover
for RJ45 wall outlet

Robust

no moving parts
fiber glass housing

Project Overview

- **Planner:** Consultant GPC GmbH, Hessheim
- **Main contractor:** Siemens (camera and cabling)
- **Camera setup:** WVE-GmbH, KL city authority (PCs)
- **Police:** Polizeioberrat Uwe Giertzsch

Cameras:

- 77 MOBOTIX- cameras (M10 Day/Night, D10 Dual-Dome)
- 4 Siemens analog PTZ-domes
- 6 TVI-Lederer analog PTZ-zoom cameras

Software:

- **Recording:** using functionality inside camera (no extra cost)
- **Control Center:** MOBOTIX MxViewer (free of charge)



Megapixel
1280 x 960
software zoom

30 Frames/s
VGA (640 x 480)
10 F/s Mega

-22° F ... +140° F

Weatherproof
-30° ... +60° C, IP65
no heating necessary

IEEE 802.3af
PoE
network power
even in winter

microphone & speaker

Audio

bi-directional via IP
variable framerate

SIP-Client with video

IP-Telephony

alarm notify,
cam remote control

Video motion

multiple windows
precision pixel-based

lip-synchronized audio

Recording

event-ringbuffer
30 cams each 30 F/s

Live viewing

30 cams at 30 F/s
all on one screen

Backlight

safe using CMOS
without mechanical iris

Wall bracket

with cable cover
for RJ45 wall outlet

Robust

no moving parts
fiber glass housing

System Diagram

Security-Vision-Systems

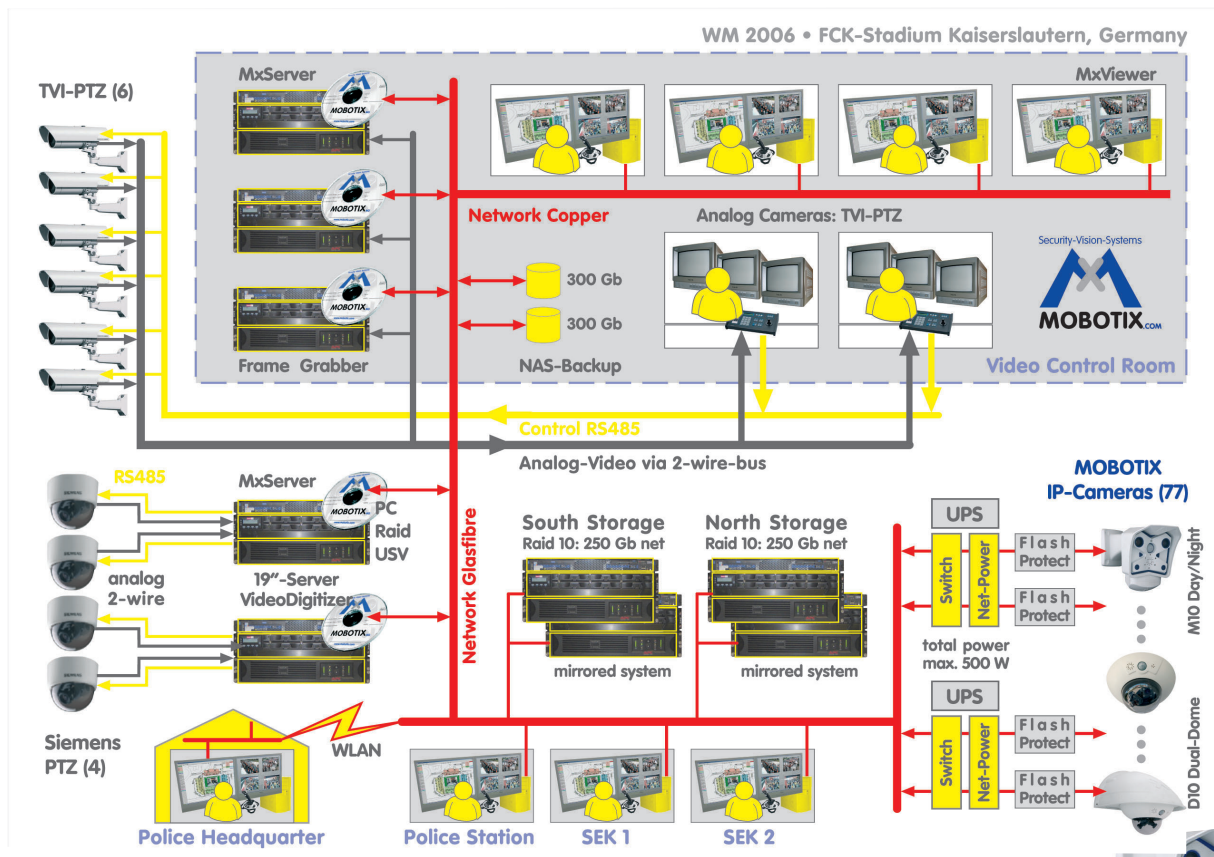

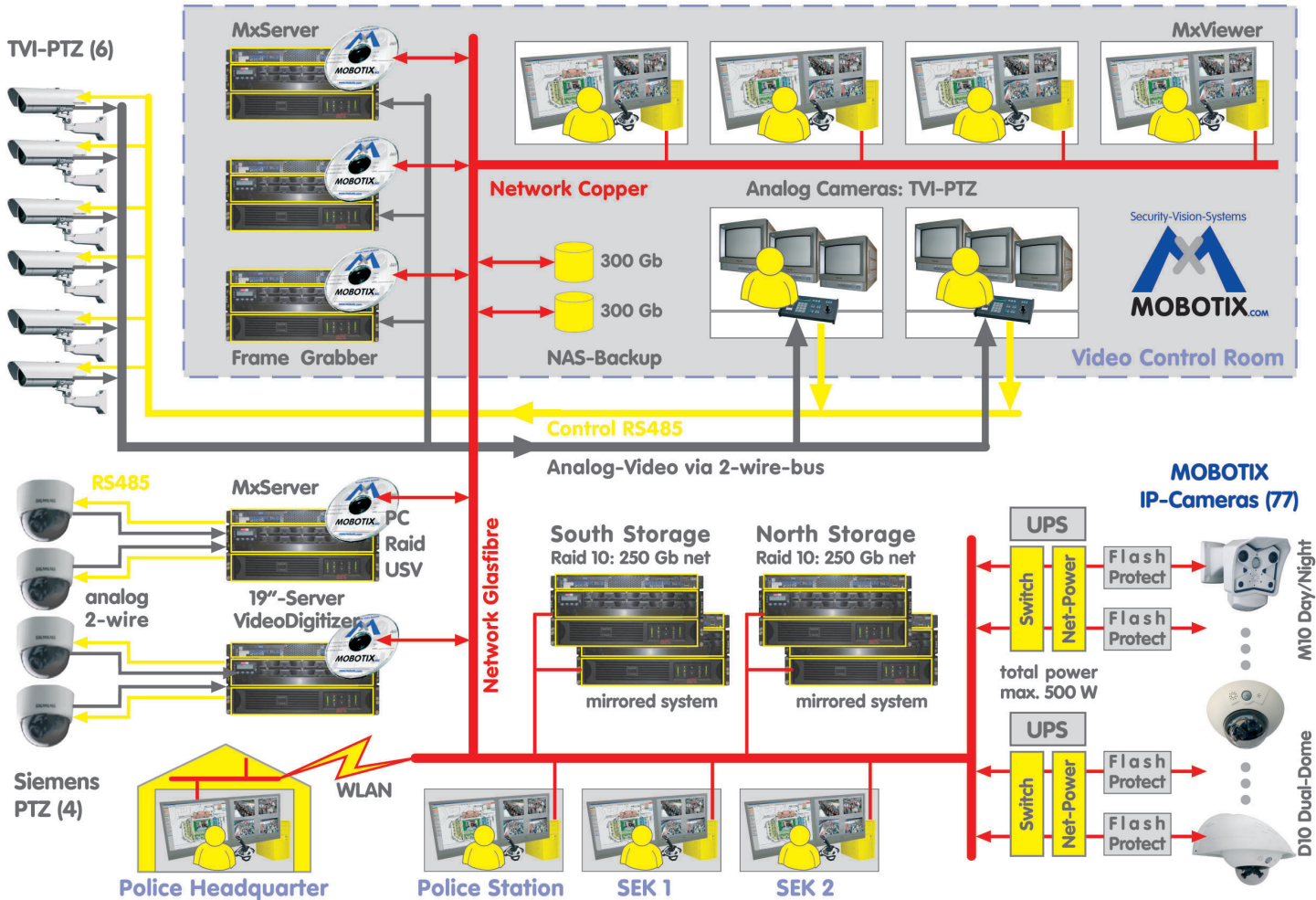

Megapixel
1280 x 960
software zoom

30 Frames/s
VGA (640 x 480)
10 F/s Mega

-22° F ... +140° F

Weatherproof
-30° ... +60° C, IP65
no heating necessary

IEEE 802.3af

PoE

network power
even in winter

microphone & speaker

Audio

bi-directional via IP
variable framerate

SIP-Client with video

IP-Telephony
alarm notify,
cam remote control

Video motion
multiple windows
precision pixel-based

lip-synchronized audio

Recording

event-ringbuffer
30 cams each 30 F/s

Live viewing

30 cams at 30 F/s
all on one screen

Backlight

safe using CMOS
without mechanical iris

Wall bracket

with cable cover
for RJ45 wall outlet

Robust

no moving parts
fiber glass housing

Easy Wiring without AC

Security-Vision-Systems

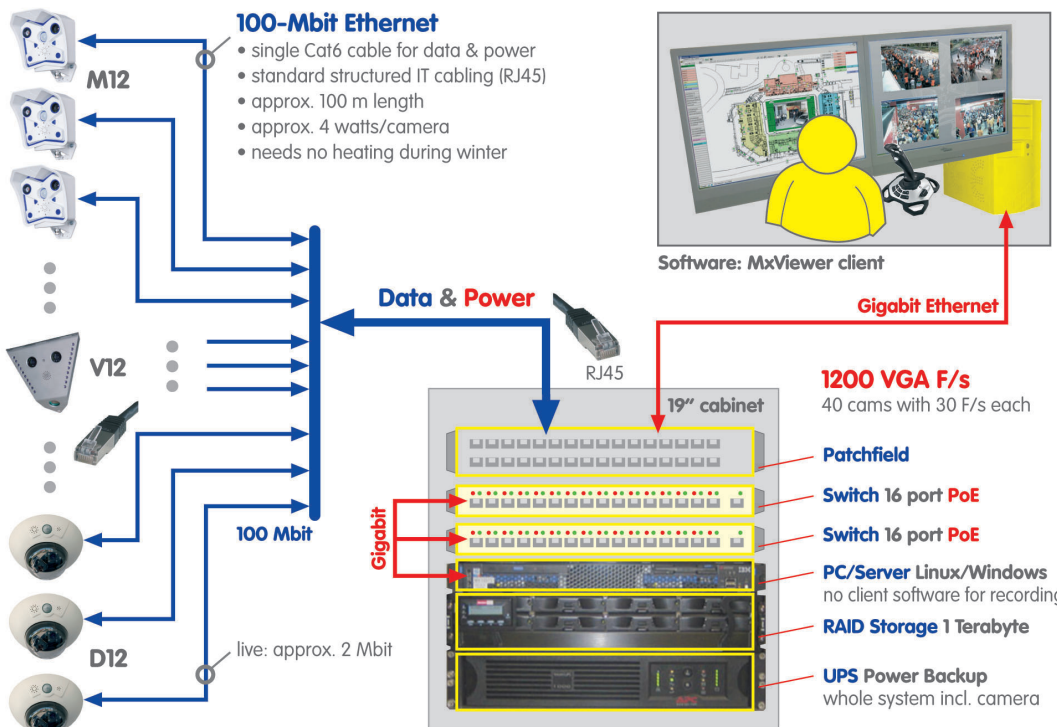

Megapixel
1280 x 960
software zoom

30 Frames/s
VGA (640 x 480)
10 F/s Mega

-22° F ... +140° F

Weatherproof
-30° ... +60° C, IP65
no heating necessary

IEEE 802.3af

PoE

network power
even in winter

microphone & speaker

Audio

bi-directional via IP
variable framerate

SIP-Client with video

IP-Telephony

alarm notify,
cam remote control

Video motion

multiple windows
precision pixel-based

lip-synchronized audio

Recording

event-ringbuffer
30 cams each 30 F/s

Live viewing

30 cams at 30 F/s
all on one screen

Backlight

safe using CMOS
without mechanical iris

Wall bracket

with cable cover
for RJ45 wall outlet

Robust

no moving parts
fiber glass housing

MxViewer with Dual Screen

Security-Vision-Systems



MOBOTIX AG • Security Vision Systems • Made in Germany • www.mobotix.com



Megapixel
1280 x 960
software zoom

30 Frames/s
VGA (640 x 480)
10 F/s Mega

-22 °F ... +140 °F

Weatherproof
-30 °C ... +60 °C, IP65
no heating necessary

PoE
network power
even in winter

microphone & speaker

Audio
bi-directional via IP
variable frame rates

SIP-Client with video
IP-Telephony
alarm notify,
cam remote control

Video motion
multiple windows
precision pixel-based

lip-synchronized audio

Recording
event-ringbuffer
30 cams each 30 F/s

Live viewing
30 cams at 30 F/s
all on one screen

Backlight
safe using CMOS
without mechanical iris

Wall bracket
with cable cover
for RJ45 wall outlet

Robust
no moving parts
fiber glass housing

MxViewer Handles 87 Cameras

Security-Vision-Systems



The screenshot displays the MxViewer software interface. On the left, a vertical list of camera names is shown, including 'Nord+2', 'Nord+1', 'Nord 0', 'Nord-1', 'Nord-4', 'West', 'Dtl', 'Süd', 'Vorkontrolle', 'Nord Ebene +3', 'Nord Ebene -1', 'Nord Ottmar Walter To', 'Nord Aussen Ebene 4', 'Spiel- & Presse', 'Restaurant', 'Süd Drehkreuz', 'Süd Ebene 0', 'Süd Aussen Ebene 0', 'Dtl Drehkreuz', 'Dtl Aussen Ebene 0', 'Dtl Aufgange Ebene 0', 'Dtl Ebene 0', 'West Drehkreuz', 'West Aussen Ebene 0', 'West Aufgange Ebene', 'West Ebene 0', 'TK-Kameras', and 'Sensoren Ebene'. The main area shows a detailed floor plan of a building with 87 camera icons (labeled NW-01 to NW-87) distributed across various levels and areas. A central video window displays a live feed from camera NW-01, showing an outdoor scene with a car and people. On the right, a control panel includes 'State Sequencer', 'Konf. Sequencer', and a list of nodes (Nord+2, Nord+1, Nord 0, Nord-1, Nord-4, Süd, Vorkontrolle) with status indicators. The top status bar shows 'MxV: 6.0 Kba/s: 52 11:15:22 Mi 23.08.06'.

MOBOTIX AG • Security Vision Systems • Made in Germany • www.mobotix.com



Megapixel
1280 x 960
software zoom

30 Frames/s
VGA (640 x 480)
10 F/s Mega

-22° F ... +140° F
Weatherproof
-30° ... +60° C, IP65
no heating necessary

IEEE 802.3af
PoE
network power
even in winter

microphone & speaker
Audio
bi-directional via IP
variable framerates

SIP-Client with video
IP-Telephony
alarm notify,
cam remote control

Video motion
multiple windows
precision pixel-based

lip-synchronized audio
Recording
event-ringbuffer
30 cams each 30 F/s

Live viewing
30 cams at 30 F/s
all on one screen

Backlight
safe using CMOS
without mechanical iris

Wall bracket
with cable cover
for RJ45 wall outlet

Robust
no moving parts
fiber glass housing

Color-Based Overview

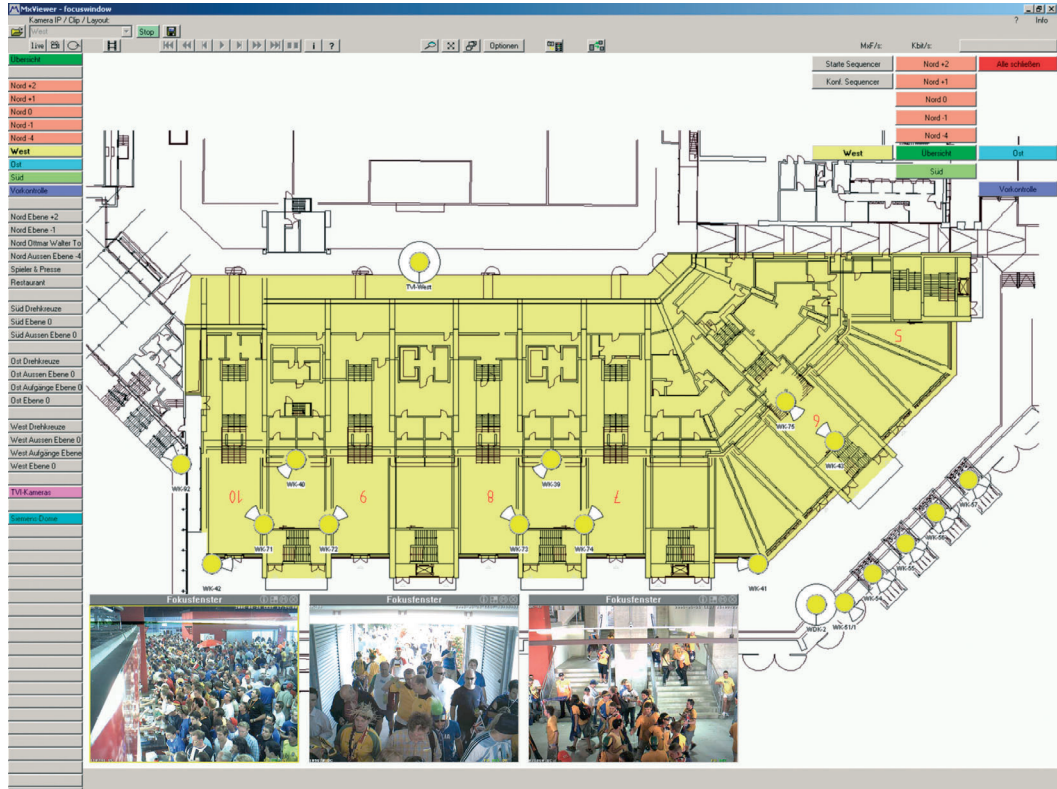

Megapixel
1280 x 960
software zoom

30 Frames/s
VGA (640 x 480)
10 F/s Mega

-22° F ... +140° F

Weatherproof
-30° ... +60° C, IP65
no heating necessary

IEEE 802.3af

PoE

network power
even in winter

microphone & speaker

Audio

bi-directional via IP
variable framerates

SIP-Client with video

IP-Telephony

alarm notify,
cam remote control

Video motion

multiple windows
precision pixel-based

lip-synchronized audio

Recording

event-ringbuffer
30 cams each 30 F/s

Live viewing

30 cams at 30 F/s
all on one screen

Backlight

safe using CMOS
without mechanical iris

Wall bracket

with cable cover
for RJ45 wall outlet

Robust

no moving parts
fiber glass housing

Event Search

Security-Vision-Systems



Event Search

Reference point: 07:53:22 Wed 21.06.2006 Time difference: 00:04:48 07:47:06 Wed 21.06.2006

Event List | Cameras

Date & Time	Sequence	EventNo	Events
07:20:21 Wed 21.06.2006	6518	0	EC
07:22:26 Wed 21.06.2006	6519	0	EC
07:38:37 Wed 21.06.2006	6520	0	EC
07:40:37 Wed 21.06.2006	6521	0	EC
07:42:11 Wed 21.06.2006	6522	0	EC
07:42:18 Wed 21.06.2006	6523	0	EC
07:42:42 Wed 21.06.2006	6524	0	EC
07:45:18 Wed 21.06.2006	6525	0	EC
07:47:06 Wed 21.06.2006	6526	0	EC
07:50:08 Wed 21.06.2006	6527	0	EC
07:52:20 Wed 21.06.2006	6528	0	EC
07:53:22 Wed 21.06.2006	6529	0	EC
07:58:22 Wed 21.06.2006	6530	0	EC
07:58:35 Wed 21.06.2006	6531	0	EC
07:59:34 Wed 21.06.2006	6532	0	EC
08:00:22 Wed 21.06.2006	6533	0	EC
08:01:53 Wed 21.06.2006	6534	0	EC

Search Parameters

Event(s): all
Event time: 08:00:22 Wed 21.06.2006 Search

Time range: Status: Time: 20:46:54



Megapixel
1280 x 960
software zoom

30 Frames/s
VGA (640 x 480)
10 F/s Mega

-22° F ... +140° F

Weatherproof
- 30° ... +60° C, IP65
no heating necessary

IEEE 802.3af

PoE
network power
even in winter

microphone & speaker

Audio
bi-directional via IP
variable framerates

SIP-Client with video

IP-Telephony
alarm notify,
cam remote control

Video motion
multiple windows
precision pixel-based

lip-synchronized audio

Recording
event-ringbuffer
30 cams each 30 F/s

Live viewing
30 cams at 30 F/s
all on one screen

Backlight
safe using CMOS
without mechanical iris

Wall bracket
with cable cover
for RJ45 wall outlet

Robust
no moving parts
fiber glass housing

Only One Camera for Four Gates

Security-Vision-Systems

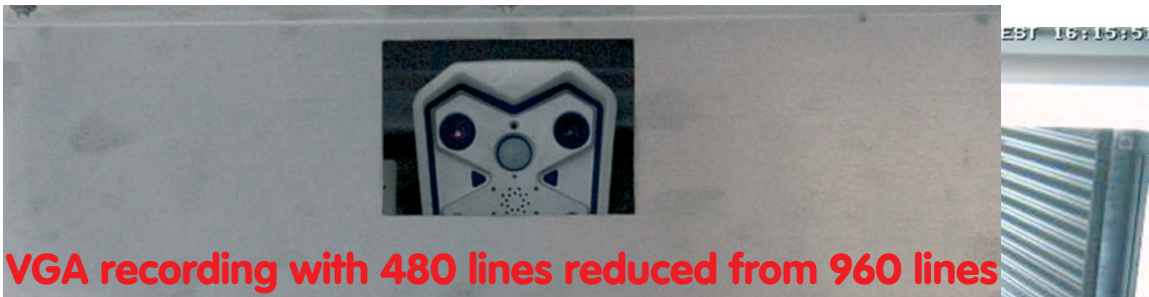

MOBOTIX AG • Security Vision Systems • Made in Germany • www.mobotix.com



Megapixel
1280 x 960
software zoom

30 Frames/s
VGA (640 x 480)
10 F/s Mega

-22 °F ... +140 °F

Weatherproof
-30 °C ... +60 °C, IP65
no heating necessary

IEEE 802.3af

PoE
network power
even in winter

microphone & speaker

Audio
bi-directional via IP
variable framerates

SIP-Client with video

IP-Telephony
alarm notify,
cam remote control

Video motion
multiple windows
precision pixel-based

lip-synchronized audio

Recording
event-ringbuffer
30 cams each 30 F/s

Live viewing
30 cams at 30 F/s
all on one screen

Backlight
safe using CMOS
without mechanical iris

Wall bracket
with cable cover
for RJ45 wall outlet

Robust
no moving parts
fiber glass housing

VGA with 480 Lines

Security-Vision-Systems

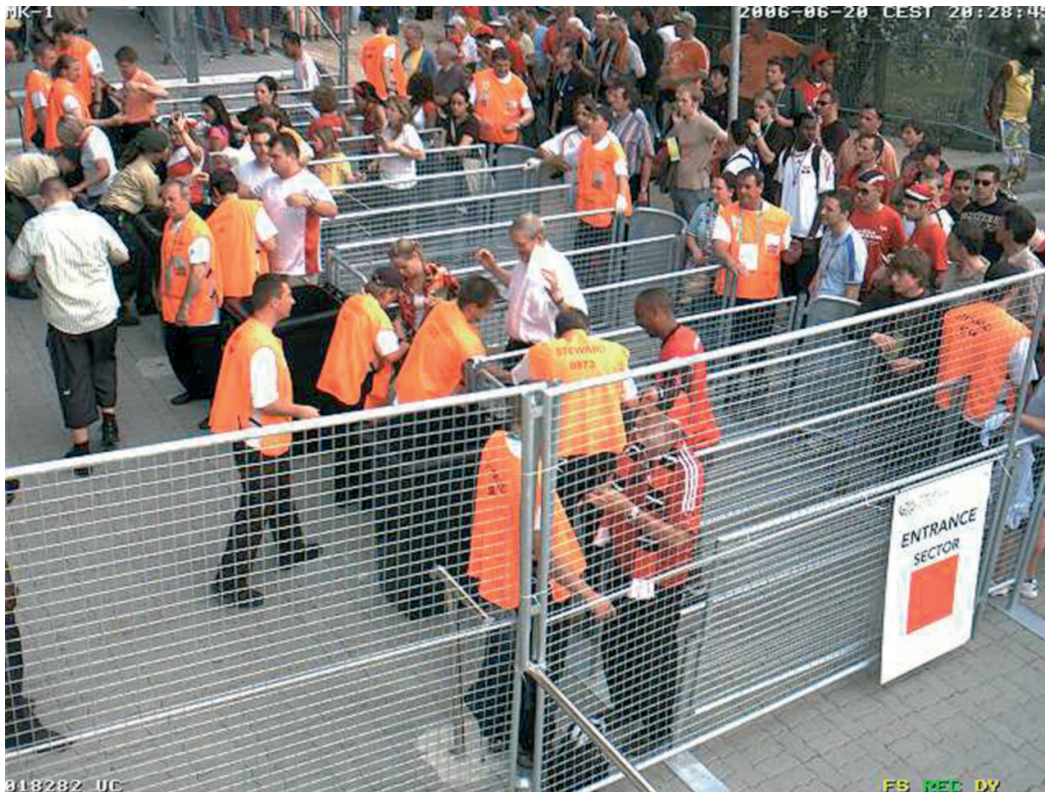

Megapixel
1280 x 960
software zoom

30 Frames/s
VGA (640 x 480)
10 F/s Mega

-22° F ... +140° F

Weatherproof
-30° ... +60° C, IP65
no heating necessary

IEEE 802.3af

PoE

network power
even in winter

microphone & speaker

Audio

bi-directional via IP
variable framerates

SIP-Client with video

IP-Telephony

alarm notify,
cam remote control

Video motion

multiple windows
precision pixel-based

lip-synchronized audio

Recording

event-ringbuffer
30 cams each 30 F/s

Live viewing

30 cams at 30 F/s
all on one screen

Backlight

safe using CMOS
without mechanical iris

Wall bracket

with cable cover
for RJ45 wall outlet

Robust

no moving parts
fiber glass housing

VGA with 480 Lines

Security-Vision-Systems



MOBOTIX AG • Security Vision Systems • Made in Germany • www.mobotix.com



Megapixel
1280 x 960
software zoom

30 Frames/s
VGA (640 x 480)
10 F/s Mega

-22 °F ... +140 °F

Weatherproof
-30 ° ... +60 °C, IP65
no heating necessary

IEEE 802.3af

PoE
network power
even in winter

microphone & speaker

Audio
bi-directional via IP
variable framerates

SIP-Client with video

IP-Telephony
alarm notify,
cam remote control

Video motion
multiple windows
precision pixel-based

lip-synchronized audio

Recording
event-ringbuffer
30 cams each 30 F/s

Live viewing
30 cams at 30 F/s
all on one screen

Backlight
safe using CMOS
without mechanical iris

Wall bracket
with cable cover
for RJ45 wall outlet

Robust
no moving parts
fiber glass housing

Mega with 960 Lines

Security-Vision-Systems



Megapixel
1280 x 960
software zoom

30 Frames/s
VGA (640 x 480)
10 F/s Mega

-22° F ... +140° F

Weatherproof
- 30° ... +60° C, IP65
no heating necessary

IEEE 802.3af

PoE
network power
even in winter

microphone & speaker

Audio
bi-directional via IP
variable framerates

SIP-Client with video

IP-Telephony
alarm notify,
cam remote control

Video motion
multiple windows
precision pixel-based

lip-synchronized audio

Recording
event-ringbuffer
30 cams each 30 F/s

Live viewing
30 cams at 30 F/s
all on one screen

Backlight
safe using CMOS
without mechanical iris

Wall bracket
with cable cover
for RJ45 wall outlet

Robust
no moving parts
fiber glass housing

D12: Dual Fix Dome: Two-in-One

Security-Vision-Systems



Dual-Fixdome
D12

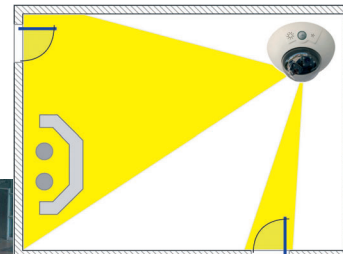

Megapixel
1280 x 960
software zoom

30 Frames/s
VGA (640 x 480)
10 F/s Mega

-22° F ... +140° F

Weatherproof
-30° ... +60° C, IP65
no heating necessary

IEEE 802.3af

PoE

network power
even in winter

microphone & speaker

Audio

bi-directional via IP
variable framerates

SIP-Client with video

IP-Telephony

alarm notify,
cam remote control

Video motion

multiple windows
precision pixel-based

lip-synchronized audio

Recording

event-ringbuffer
30 cams each 30 F/s

Live viewing

30 cams at 30 F/s
all on one screen

Backlight

safe using CMOS
without mechanical iris

Wall bracket

with cable cover
for RJ45 wall outlet

Robust

no moving parts
fiber glass housing

Easy Installation

Security-Vision-Systems

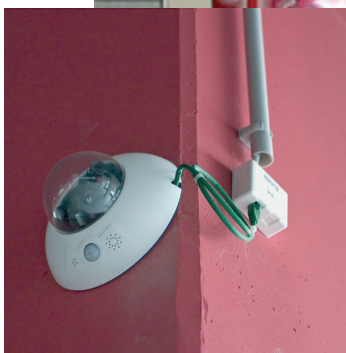

MOBOTIX AG • Security Vision Systems • Made in Germany • www.mobotix.com



Megapixel
1280 x 960
software zoom

30 Frames/s
VGA (640 x 480)
10 F/s Mega

-22 °F ... +140 °F

Weatherproof
-30 °C ... +60 °C, IP65
no heating necessary

IEEE 802.3af

PoE

network power
even in winter

microphone & speaker

Audio

bi-directional via IP
variable framerates

SIP-Client with video

IP-Telephony

alarm notify,
cam remote control

Video motion

multiple windows
precision pixel-based

lip-synchronized audio

Recording

event-ringbuffer
30 cams each 30 F/s

Live viewing

30 cams at 30 F/s
all on one screen

Backlight

safe using CMOS
without mechanical iris

Wall bracket

with cable cover
for RJ45 wall outlet

Robust

no moving parts
fiber glass housing

Hi Res Recording Needs Less Cameras

Security-Vision-Systems



1.3 Megapixel

Mega
10 fps
960 lines

0.3 Megapixel

VGA
30 fps
480 lines

0.1 Megapixel

CIF
30 fps
288 lines

PS-UV 90
MOBOTIX
960 lines

PS-UV 90
Standard
288 lines
CIF/2CIF

FB REC



Megapixel
1280 x 960
software zoom

30 Frames/s
VGA (640 x 480)
10 F/s Mega

-22° F ... +140° F

Weatherproof
-30° ... +60° C, IP65
no heating necessary

IEEE 802.3af

PoE
network power
even in winter

microphone & speaker

Audio
bi-directional via IP
variable framerates

SIP-Client with video

IP-Telephony
alarm notify,
cam remote control

Video motion
multiple windows
precision pixel-based

lip-synchronized audio

Recording
event-ringbuffer
30 cams each 30 F/s

Live viewing
30 cams at 30 F/s
all on one screen

Backlight
safe using CMOS
without mechanical iris

Wall bracket
with cable cover
for RJ45 wall outlet

Robust
no moving parts
fiber glass housing

Face Recognition Requires Hi Res Recording

Security-Vision-Systems

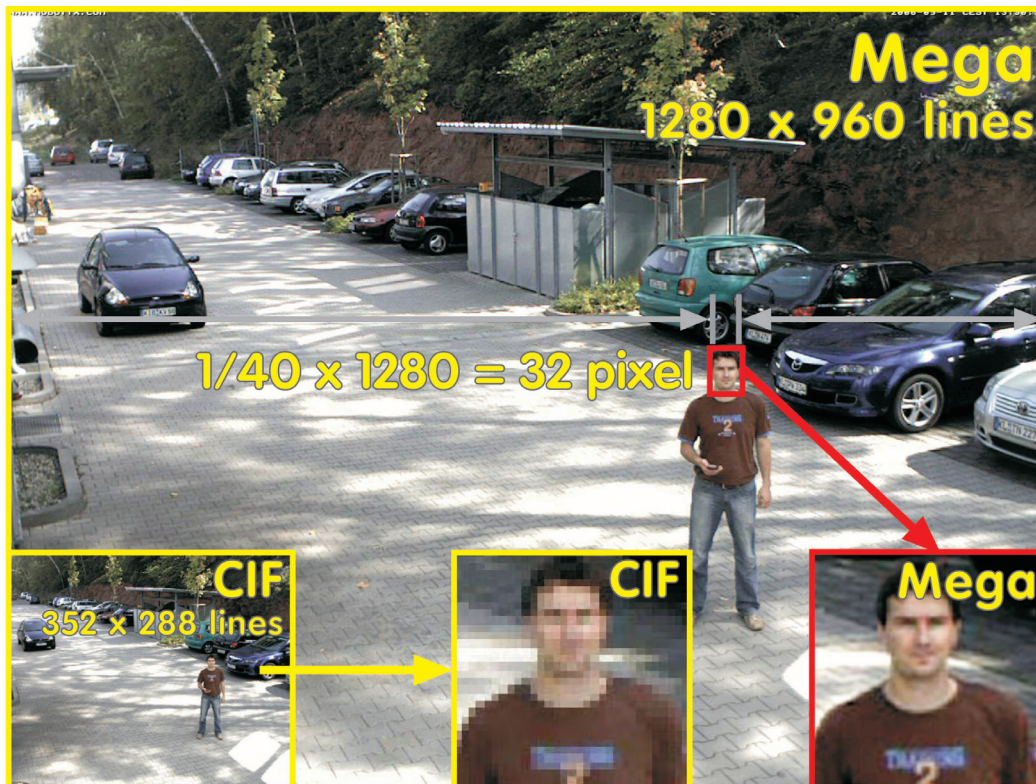

Megapixel
1280 x 960
software zoom

30 Frames/s
VGA (640 x 480)
10 F/s Mega

-22° F ... +140° F

Weatherproof
-30° ... +60° C, IP65
no heating necessary

IEEE 802.3af

PoE

network power
even in winter

microphone & speaker

Audio

bi-directional via IP
variable framerates

SIP-Client with video

IP-Telephony

alarm notify,
cam remote control

Video motion

multiple windows
precision pixel-based

lip-synchronized audio

Recording

event-ringbuffer
30 cams each 30 F/s

Live viewing

30 cams at 30 F/s
all on one screen

Backlight

safe using CMOS
without mechanical iris

Wall bracket

with cable cover
for RJ45 wall outlet

Robust

no moving parts
fiber glass housing

Central Power Backup Reduces Cost

Security-Vision-Systems

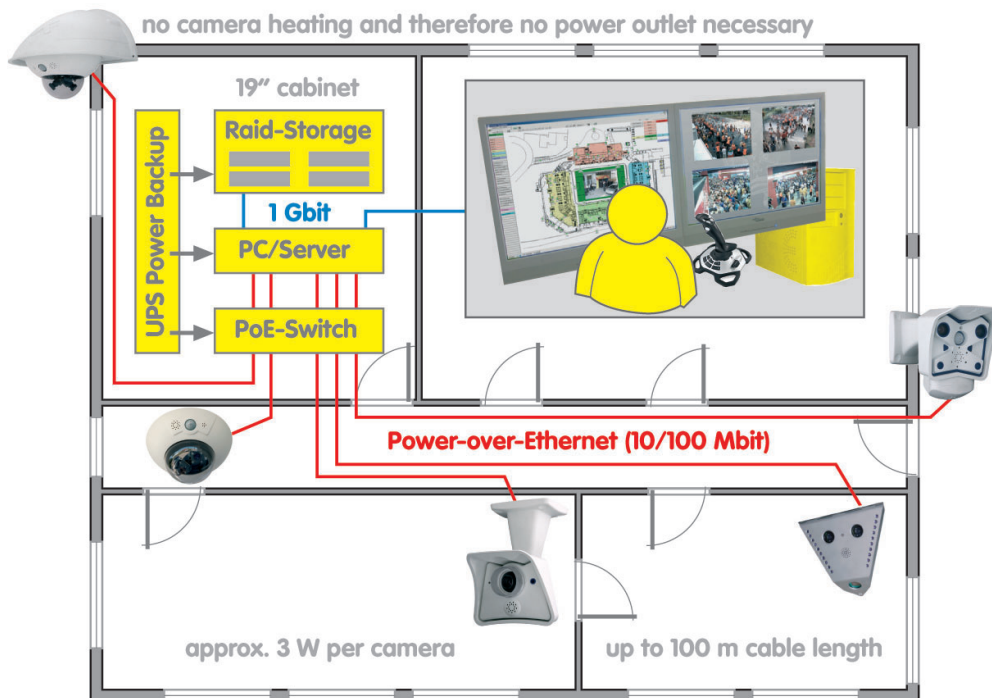

Megapixel
1280 x 960
software zoom

30 Frames/s
VGA (640 x 480)
10 F/s Mega

-22° F ... +140° F

Weatherproof
- 30° ... +60° C, IP65
no heating necessary

IEEE 802.3af

PoE

network power
even in winter

microphone & speaker

Audio

bi-directional via IP
variable framerates

SIP-Client with video

IP-Telephony

alarm notify,
cam remote control

Video motion

multiple windows
precision pixel-based

lip-synchronized audio

Recording

event-ringbuffer
30 cams each 30 F/s

Live viewing

30 cams at 30 F/s
all on one screen

Backlight

safe using CMOS
without mechanical iris

Wall bracket

with cable cover
for RJ45 wall outlet

Robust

no moving parts
fiber glass housing

Efficient Power Supply

Security-Vision-Systems



- complete power supply via network cable
- 77 MOBOTIX cameras including network components need less than 500 W (net 3 Watt/camera)
 - ==> no heating necessary
 - ==> no 230 V, no AC plug at camera
 - ==> IT-UPS inside 19" rack at switch & patch panel
- flash protection at network cable (RJ45-RJ45)



Megapixel
1280 x 960
software zoom

30 Frames/s
VGA (640 x 480)
10 F/s Mega

-22° F ... +140° F

Weatherproof
-30° ... +60° C, IP65
no heating necessary

IEEE 802.3af

PoE

network power
even in winter

microphone & speaker

Audio

bi-directional via IP
variable framerates

SIP-Client with video

IP-Telephony

alarm notify,
cam remote control

Video motion

multiple windows
precision pixel-based

lip-synchronized audio

Recording

event-ringbuffer
30 cams each 30 F/s

Live viewing

30 cams at 30 F/s
all on one screen

Backlight

safe using CMOS
without mechanical iris

Wall bracket

with cable cover
for RJ45 wall outlet

Robust

no moving parts
fiber glass housing

Main Reasons to Use MOBOTIX at the Stadium

Security-Vision-Systems



- **high resolution with 960 lines records more details**
minimizes number of cameras and cable installation
 - **intelligent recording technique reduces number of DVRs**
up to 40 cameras stream to one PC with raid system
 - **cost reduction thanks to efficient power concept**
all-season via network cable, because cameras need no heating
 - **simple integration of analog PTZ systems from TVI & Siemens**
via PC with frame grabber and MxServer software (free of charge)
 - **live & recording video is available in all control centers over the city**
IP based video can easily be distributed without additional equipment
 - **fast display of all cameras at one monitoring place**
using a PC with two TFT monitors and MxViewer (free of charge)
- ==> MOBOTIX was the cheapest system**



Megapixel
1280 x 960
software zoom

30 Frames/s
VGA (640 x 480)
10 F/s Mega

-22° F ... +140° F

Weatherproof
- 30° ... +60° C, IP65
no heating necessary

IEEE 802.3af

PoE

network power
even in winter

microphone & speaker

Audio

bi-directional via IP
variable framerates

SIP-Client with video

IP-Telephony

alarm notify,
cam remote control

Video motion

multiple windows
precision pixel-based

lip-synchronized audio

Recording

event-ringbuffer
30 cams each 30 F/s

Live viewing

30 cams at 30 F/s
all on one screen

Backlight

safe using CMOS
without mechanical iris

Wall bracket

with cable cover
for RJ45 wall outlet

Robust

no moving parts
fiber glass housing

All Games without Problems

Security-Vision-Systems



MOBOTIX AG • Security Vision Systems • Made in Germany • www.mobotix.com



Megapixel
1280 x 960
software zoom

30 Frames/s
VGA (640 x 480)
10 F/s Mega

-22° F ... +140° F

Weatherproof
- 30° ... +60° C, IP65
no heating necessary

IEEE 802.3af

PoE
network power
even in winter

microphone & speaker

Audio
bi-directional via IP
variable framerates

SIP-Client with video

IP-Telephony
alarm notify,
cam remote control

Video motion
multiple windows
precision pixel-based

lip-synchronized audio

Recording
event-ringbuffer
30 cams each 30 F/s

Live viewing
30 cams at 30 F/s
all on one screen

Backlight
safe using CMOS
without mechanical iris

Wall bracket
with cable cover
for RJ45 wall outlet

Robust
no moving parts
fiber glass housing

