

Features and Product Update

DrayTek Corp
Marketing Department

Comparison of Broadband

		2900 / 2900V	2910	2930	2950
Dual-WAN		-	V	V	V
VPN	Tunnel	32	32	100	200
	Encryption	H/W DES/3DES S/W MPPE/AES	H/W DES/3DES S/W MPPE/AES	H/W AES/DES/3DES S/W MPPE	H/W AES/DES/3DES S/W MPPE
	Authentication	S/W MD5/SHA-1	S/W MD5/SHA-1	H/W MD5/SHA-1	H/W MD5/SHA-1
	Key Exchange	Pre-shared Key	Pre-shared Key/CA	Pre-shared Key/CA	Pre-shared Key/CA
VoIP	Registrar	0 / 2 dedicated	6	12	-
	ISDN FXS (S0)	-	-	V	-
	ISDN FXO	-	V	V	-
Wireless	Solution	IEEE 802.11g	Super G™	IEEE 802.11n	Super G™
	VLAN	-	V	V	V
	Rate-Control	-	V	V	V
	WDS	- / V	V	V	V
Firewall	Object-Originated	-	V	V	V
	Content Filter	URL / URL&Web	URL&Web	URL&Web	URL&Web
	CSM	IM&P2P blocking	V	V	V
	IP/MAC Binded	MAC Address Filter	V	V	V
Bandwidth Management	QoS	V	V	V	V
	NAT/Bandwidth	-	V	V	V

DrayTek

DrayTek

DrayTek

VIGOROUS BROADBAND ACCESS

DrayTek

DrayTek

Vigor2930 Product Line

	2930	2930n	2930Vn	2930VS	2930VSn
Dual-WAN	V	V	V	V	V
Wireless	-	802.11n	802.11n	-	802.11n
FXS	-	-	2	2	2
ISDN FXS (S0)	-	-	-	2	2
ISDN FXO	-	-	-		
ISDN Loop-through	-	-	-		

Vigor2930 Product Line

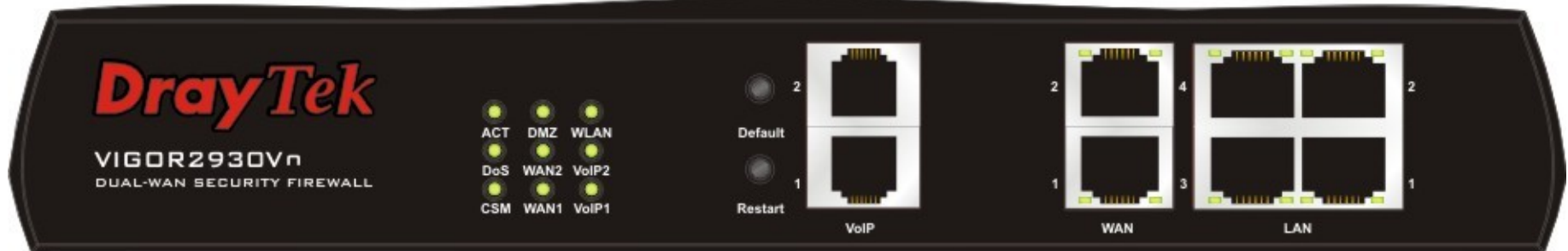
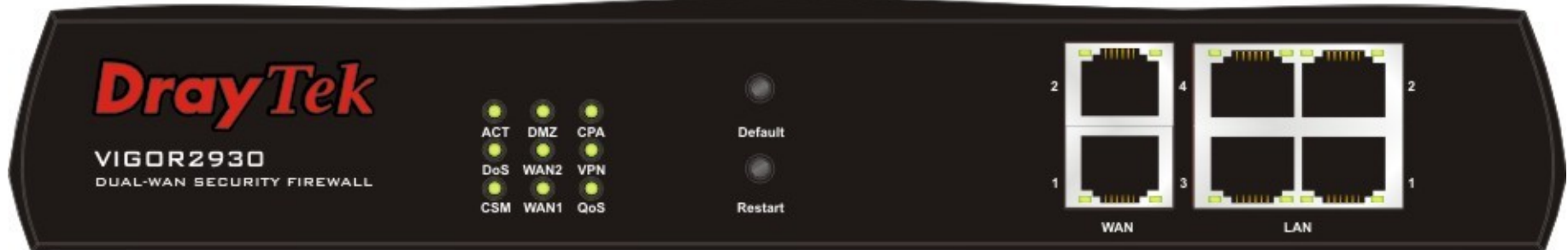

DrayTek

DrayTek

DrayTek

VIGOROUS BROADBAND ACCESS

DrayTek

DrayTek

Vigor2930 Product Line

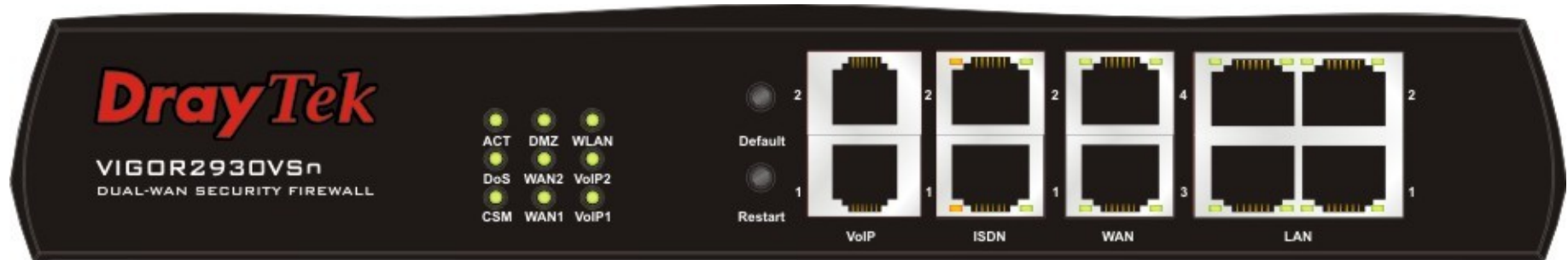
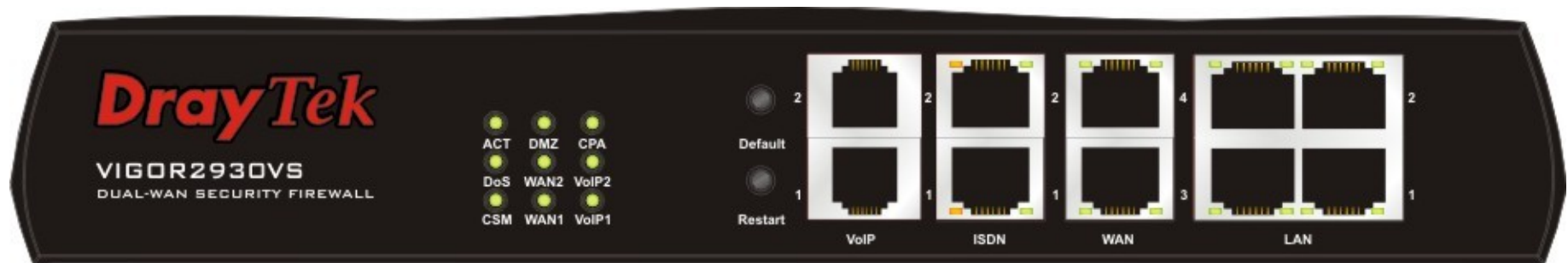

DrayTek

DrayTek

DrayTek

VIGOROUS BROADBAND ACCESS

DrayTek

DrayTek

Vigor2930 Series

- **High-integration with 802.11n, VoIP and ISDN**
- **Dual-WAN with policy-based Load-Balance and Fail-Over/BoD**
- **Wireless Security**
 - **WEP/WPA/WPA2 Encryption, MAC Address Control, Wireless LAN Isolation, Wireless VLAN and 802.1X Authentication**
- **WDS (Wireless Distribution System), Wireless AP Discovery and Rate Control support**

Vigor2930 Series

- **One dozen SIP registrars**
- **Two FXS ports**
- **One Fixed ISDN NT and one configurable TE/NT ports**
- **Supplementary services**
 - **Call Hold/Retrieve, Call Waiting, Call Transfer, Call Forwarding, Call Barring, DND (Do Not Disturb), MWI (Message Waiting Indicator), Hotline, T.38, Phone Book and Digit Map**
- **Bandwidth/NAT session limitation**

Vigor2930 Series

- **QoS**
 - Class-based bandwidth guarantee by user-defined traffic categories
 - 4-level priority for each direction (Inbound/Outbound)
 - Assure bandwidth for own VoIP service
- **Object-Oriented Firewall makes setting of policies easy**
- **Firewall supports IP Filter, DoS/DDoS Prevention, Web/URL Content Filter**
- **CSM (Content Security Management) allows more precise and efficient access control for IM/P2P applications**

Vigor2930 Series

- **100 VPN tunnels with MPPE, Hardware-based DES/3DES/AES encryption and Hardware-based MD5/SHA-1 Authentication**
- **HTTPS and SSH secure management**

Vigor2930 Schedule

Products	MP
Vigor2930/VS	End of May.
Vigor2930nVn/VSn	End of Jun.

Term of ISDN

- **NT (Network Terminal)**
 - ISDN S0 intern
 - Connect to ISDN Phone
- **TE (Terminal Equipment)**
 - ISDN S0 extern
 - Connect to ISDN Line

Functions of TR-069

- **Auto-configuration and provisioning**
 - Initial CPE configuration
 - Auto-provisioning at any defined time
- **Firmware upgrade**
 - Version identification
 - File download initiation
 - Notification of the success or failure of a file download
- **Status and performance monitoring**
 - Log file, and dynamic notification
- **Diagnostics**
 - Connectivity and service issues

Scope of TR-069

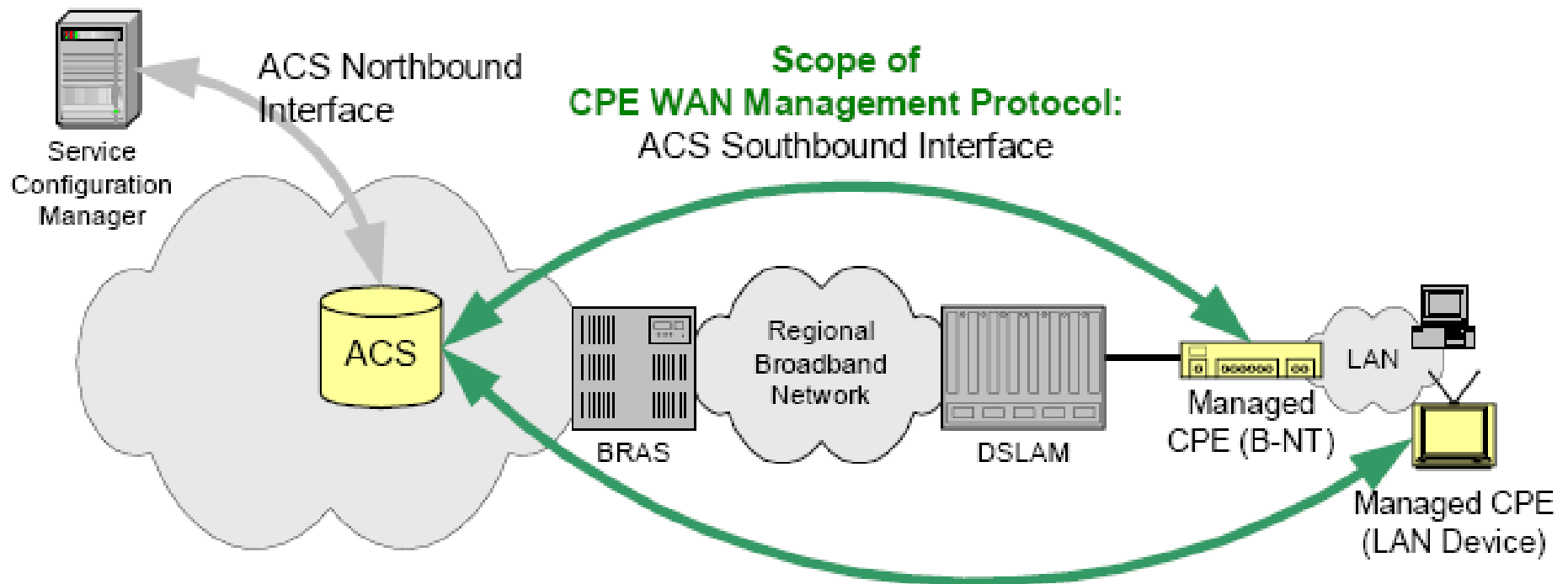

TR-104

- **Define parameters for VoIP CPE as an extension to TR-069**
- **A solution of VoIP Auto-provisioning**

DrayTek Anti-Spam

- **Support POP3 and SMTP**
- **8 Profile integrated into Object Firewall**
- **Whitelist/Blacklist**
- **Power by Commtouch**

DrayTek

DrayTek

DrayTek

VIGOROUS BROADBAND ACCESS

DrayTek

DrayTek

Category and Action for E-Mail

- **Three Categories**

- **Spam** : E-Mail identified as Spam or Phishing
- **Bulk** : Sent in large quantities, such as newsletters
- **Suspect** : E-Mails suspected of being Spam or Bulk

- **Two Actions**

- **Pass** : Pass this E-Mail
- **Tag** : Add a tag on the E-Mail subject

Add a Tag on E-Mail Subject

Anti-Spam >> General Setup

Profile Index : 1

Profile Name:

Choose Protocol to Scan Spam

SMTP POP3

Select an Action for Each Category

Category	Action	Log	Message(Max 30 characters)
Spam	Tag <input type="button" value="v"/>	<input checked="" type="checkbox"/>	***SPAM***
Bulk	Tag <input type="button" value="v"/>	<input checked="" type="checkbox"/>	###BULK###
Suspect	Pass <input type="button" value="v"/>	<input type="checkbox"/>	

DraytekUTM

***SPAM**

寄件者: DraytekUTM 收件者: utm
主旨: ***SPAM*** Fw: Moon

Have erectile dysfunction?
Look no where else!

Cheapest online!

Cialis Soft Tabs as low as \$5.78
Viagra Soft Tabs..... \$4.07
Viagra Soft Tabs..... \$4.1
Cialis..... \$5.67
Generic Viagra..... \$3.5
Viagra..... \$1.38
Tramadol..... \$2.17
Cialis..... \$11.97

Buy Cialis+Viagra and get 20% discount!

DrayTek

DrayTek

DrayTek

VIGOROUS BROADBAND ACCESS

DrayTek

DrayTek

IPSec and SSL VPN

IPSec

- **Protocol**
 - ESP (Protocol 50)
 - IKE (UDP 500)
- **Encryption**
 - DES/3DSS/AES
- **NAT Traversal**
 - NAT-T (RFC-3947/3948)
- **Better for LAN-to-LAN**

SSL

- **Protocol**
 - HTTPS (TCP 443)
- **Encryption**
 - RC4
- **NAT Traversal**
 - No issue if browser works
- **Better for Remote Dial-in**

DrayTek's SSL VPN

- **Web Application**
- **Web proxy**
- **Microsoft SSTP**

DrayTek

DrayTek

DrayTek

VIGOROUS BROADBAND ACCESS

DrayTek

DrayTek

SSL VPN – Web Application

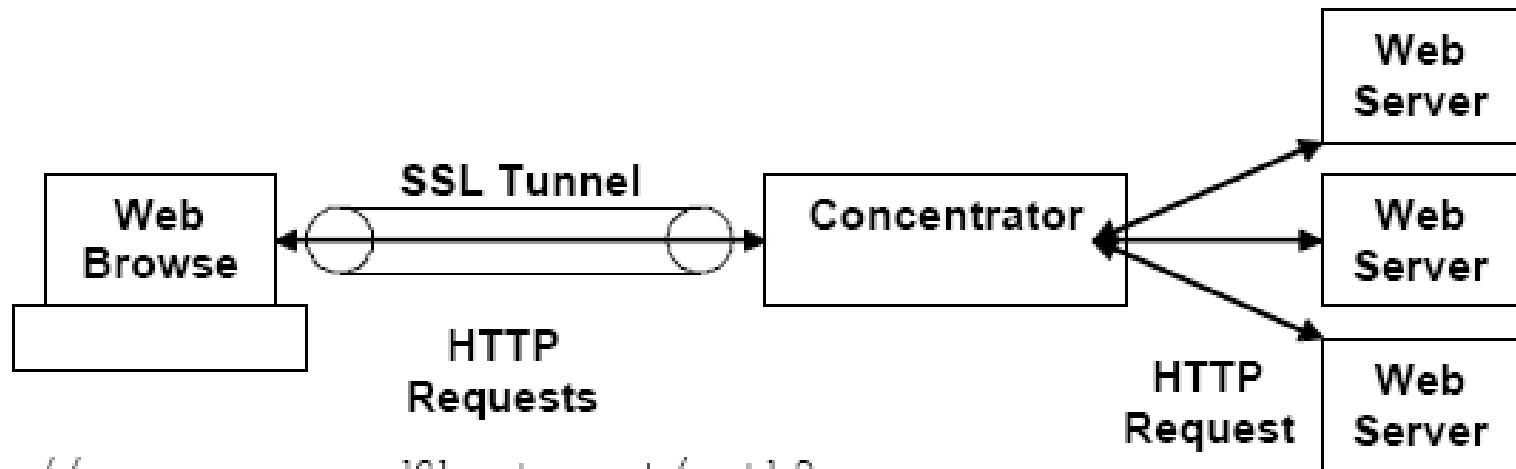

`protocol://user:password@host:port/path?query`

SSL VPN – Web Application

Web Access Control >> Web Application

Web Application Servers Profiles:

[Set to Factory Default](#)

Index	Name	URL	Active
1.	g-forge	http://swm.draytek.com	v
2.	Mantis	http://172.16.2.16/BugTrack	v
3.	2900_SPR	http://192.168.1.2	v
4.	2900_SSL	http://192.168.1.2	v
5.			x

SSL VPN - Web Proxy



DrayTek

DrayTek

DrayTek

VIGOROUS BROADBAND ACCESS

DrayTek

DrayTek

SSTP

- **Secure Socket Tunneling Protocol**
- **Microsoft's SSL VPN Solution**
- **Encapsulate PPP packets over an HTTPS session**
- **Microsoft plans to ship SSTP support in Vista Service Pack 1 and in Longhorn Server**

Key Features of SSTP

- **Use HTTPS to establish secure connection (TCP 443)**
- **No need to worry about typical port blocking issues**
- **The SSTP Server will be built in to Longhorn Server**
- **The SSTP Client will be built in to the Vista SP1**
- **Integrated NAP (Network Access Protection) support for client health-check, this means different kind of health check with extensibility by third party vendors (like antivirus, firewall, etc.)**

Multi-Play on DSL

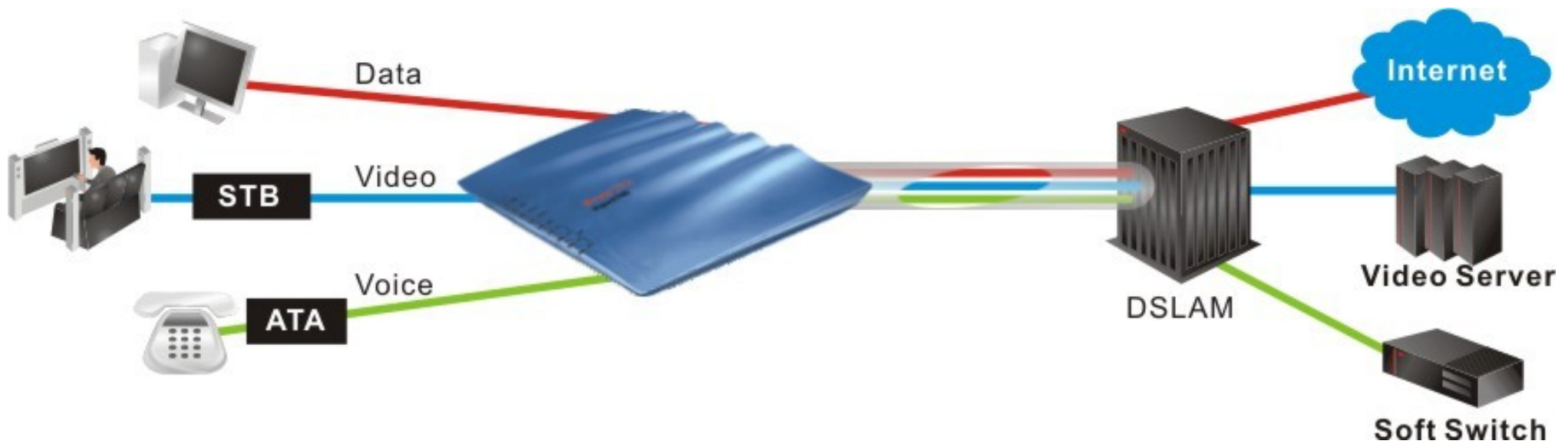

DrayTek

DrayTek

DrayTek

VIGOROUS BROADBAND ACCESS

DrayTek

DrayTek

Multi-Play on Broadband

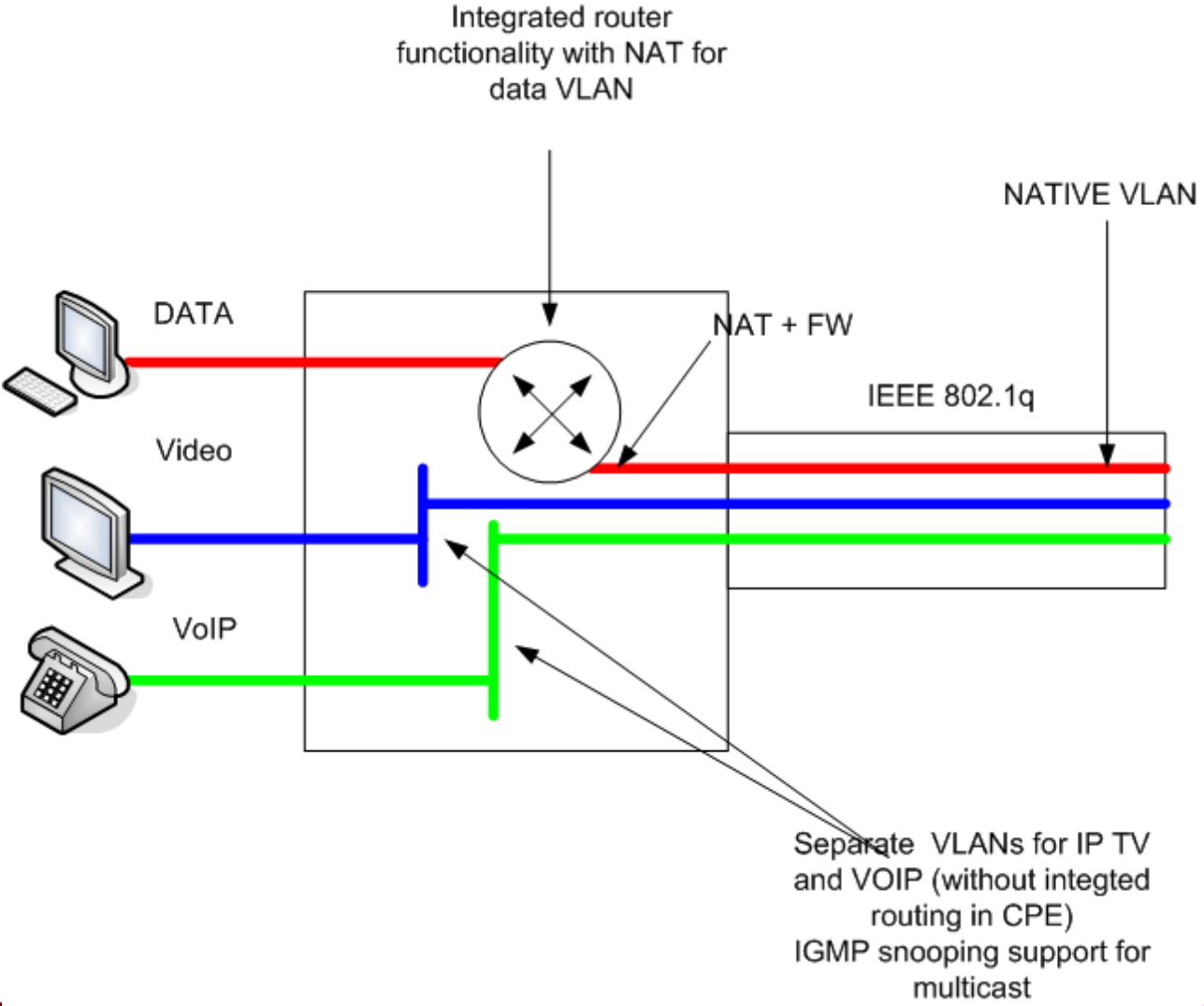

Q&A