



VERIFICATION OF COMPLIANCE

This Verification of Compliance is hereby issued to the product designated below.

Product	Data Acquisition Modules
Model	ADAM-6066
Trade name	ADVANTECH
Applicant	Advantech Co., Ltd. No. 1, Alley 20, Lane 26, Rueiguang Road, Neihu District, Taipei 114, Taiwan, R.O.C.
Applicable Standard(s)	EN 55022: 1998 (Class A) EN 55024: 1998 + A1: 2001 IEC 61000-4-2: 1995 + A2: 2000; IEC 61000-4-3: 1995 + A2: 2000; IEC 61000-4-4: 1995 + A1: 2000; IEC 61000-4-5: 1995 + A1: 2000; IEC 61000-4-6: 1996 + A1: 2000; IEC 61000-4-8: 1993 + A1: 2000
Report No.	41209201-E
Test Laboratory	Compliance Certification Services Inc. No. 81-1, Lane 210, Bade Rd., 2, Luchu Hsiang, Taoyuan Hsien, Taiwan, R.O.C. Tel: +886-3-3240332/ Fax: +886-3-3245235

This device has been tested and found to comply with the stated standard(s), which is(are) required by the Council Directive of 89/336/EEC and Amendment Directive of 93/68/EEC. The test results are indicated in the test report and are applicable only to the tested sample identified in the report.

Kurt Chen

Kurt Chen / Director of Linkou Laboratory

Date: December 23, 2004



CE EMC

TEST REPORT

For

Data Acquisition Modules

Model: ADAM-6066

Trade Name: ADVANTECH

Issued for

Advantech Co., Ltd.

**No. 1, Alley 20, Lane 26, Rueiguang Road, Neihu District,
Taipei 114, Taiwan, R.O.C.**

Issued by

Compliance Certification Services Inc.

No. 81-1, Lane 210, Bade Rd., 2, Luchu Hsiang,

Taoyuan Hsien, (338) Taiwan, R.O.C.

TEL: 886-3-324-0332

FAX: 886-3-324-5235



Note: This report shall not be reproduced except in full, without the written approval of Compliance Certification Services Inc. Ltd. This document may be altered or revised by Compliance Certification Services Inc. personnel only, and shall be noted in the revision section of the document.



TABLE OF CONTENTS

1	TEST RESULT CERTIFICATION.....	3
2	EUT DESCRIPTION.....	4
3	TEST METHODOLOGY.....	5
3.1	EUT SYSTEM OPERATION.....	5
3.2	DECISION OF FINAL TEST MODE.....	5
4	SETUP OF EQUIPMENT UNDER TEST.....	6
5	FACILITIES AND ACCREDITATIONS.....	6
5.1	FACILITIES.....	6
5.2	LABORATORY ACCREDITATIONS AND LISTINGS.....	7
6	INSTRUMENT AND CALIBRATION.....	8
6.1	MEASURING INSTRUMENT CALIBRATION.....	8
6.2	TEST AND MEASUREMENT EQUIPMENT.....	8
7	LINE CONDUCTED & RADIATED EMISSION TEST.....	11
7.1	LIMIT.....	11
7.2	TEST PROCEDURE OF LINE CONDUCTED EMISSION.....	12
7.3	TEST PROCEDURE OF COMMON MODE CONDUCTED EMISSION FOR TELECOMMUNICATION PORT.....	13
7.4	TEST PROCEDURE OF RADIATED EMISSION.....	14
7.5	TEST RESULTS.....	16
8	POWER HARMONICS TEST.....	19
9	POWER VOLTAGE FLUCTUATION / FLICKER TEST.....	21
10	ELECTROSTATIC DISCHARGE (ESD) IMMUNITY TEST.....	23
11	RADIATED ELECTROMAGNETIC FIELD IMMUNITY TEST.....	28
12	FAST TRANSIENTS/BURST IMMUNITY TEST.....	31
13	SURGE IMMUNITY TEST.....	33
14	CONDUCTED DISTURBANCE/INDUCED RADIO-FREQUENCY FIELD IMMUNITY TEST ...	35
15	POWER FREQUENCY MAGNETIC FIELD IMMUNITY TEST.....	37
16	VOLTAGE DIPS / SHORT INTERRUPTIONS.....	39
	APPENDIX I - PHOTOGRAPHS OF TEST SETUP.....	40



1 TEST RESULT CERTIFICATION

Applicant: Advantech Co., Ltd.
No. 1, Alley 20, Lane 26, Rueiguang Road, Neihu District, Taipei 114, Taiwan, R.O.C.

Manufacturer: Advantech Co., Ltd.
No. 1, Alley 20, Lane 26, Rueiguang Road, Neihu District, Taipei 114, Taiwan, R.O.C.

Equipment Under Test: Data Acquisition Modules

Trade Name: ADVANTECH

Model: ADAM-6066

Detailed EUT Description: See Item 2 of this report

Date of Test: December 16 ~ 18, 2004

Applicable Standard	Class/Limit/Criterion	Test Result
EN 55022: 1998	Class A	No non-compliance noted
EN 61000-3-2: 2000	Class A/B/C/D	N/A
EN 61000-3-3: 1995 + A1: 2001	Limit	N/A
EN 55024: 1998 + A1: 2001, including		
IEC 61000-4-2: 1995 + A2: 2000	Criterion B	No non-compliance noted
IEC 61000-4-3: 1995 + A2: 2000	Criterion A	No non-compliance noted
IEC 61000-4-4: 1995 + A1: 2000	Criterion B	No non-compliance noted
IEC 61000-4-5: 1995 + A1: 2000	Criterion B	No non-compliance noted
IEC 61000-4-6: 1996 + A1: 2000	Criterion A	No non-compliance noted
IEC 61000-4-8: 1993 + A1: 2000	Criterion A	No non-compliance noted
IEC 61000-4-11: 1994 + A1: 2000	Criterion B/C/C	N/A
Deviation from Applicable Standard		
<ol style="list-style-type: none"> 1. According to applicant's declaration this EUT is a class A product, and to be market in industrial environment only. 2. The conducted emission test item for telecom ports disturbance voltage (according to section 9.5 of EN 55022: 1998) is not tested in this report as per client's request. 		

The above equipment was tested by Compliance Certification Services Inc. for compliance with the requirements set forth in the EMC Directive 89/336/EEC and the technical standards mentioned above. The results of testing in this report apply only to the product/system, which was tested. Other similar equipment will not necessarily produce the same results due to production tolerance and measurement uncertainties.

Approved by: 
 Kurt Chen
 Director of Linkou Laboratory
 Compliance Certification Services Inc.

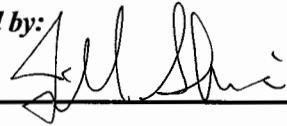
Reviewed by: 
 Jill Shiao
 Section Manager of Linkou Laboratory
 Compliance Certification Services Inc.



2 EUT DESCRIPTION

Product	Data Acquisition Modules
Trade Name	ADVANTECH
Model	ADAM-6066
Housing Type	Plastic
EUT Power Rating	DC 24V

I/O Port of EUT

I/O Port Type	Q'TY	TESTED WITH
1). LAN Port	1	1



3 TEST METHODOLOGY

3.1 EUT SYSTEM OPERATION

1. Connected EUT between the PC systems and support units.
2. EMI test program (Customer provide) was loaded executed at Host PC in “Window XP” environment.
3. EUT sent and received from Host PC via LAN Cable.
4. The EUT and Simulated Terminal (Customer consign) connected to DC Power Supply during all testing.
5. Test program sequentially exercised all related I/O’s and accessories of Host PC.
6. Repeat 3 to 5.

Note: Test program is self-repeating throughout the test.

3.2 DECISION OF FINAL TEST MODE

1. The following test mode was scanned during the preliminary test:

Mode 1

Operation Condition

2. After the preliminary scan, the following test mode was found to produce the highest emission level.

Mode 1

Then, the EUT configuration and cable configuration of the above highest emission mode was chosen for all final test items.



4 SETUP OF EQUIPMENT UNDER TEST

Setup Diagram

See test photographs attached in Appendix 1 for the actual connections between EUT and support equipment.

Support Equipment

No.	Equipment	Model No.	Serial No.	FCC ID	Trade Name	Data Cable	Power Cord
1	PC	D51C	7251 KN8Z 0013	FCC DoC	COMPAQ	LAN Cable: Unshielded, 0.1m	Unshielded, 1.8m
2	Monitor	959NF	AQ19H2RT706139P	FCC DoC	SAMSUNG	Shielded, 1.8m with two cores	Unshielded, 1.8m
3	Modem	DM-1414	304012268	IFAXDM1414	ACEEX	Unshielded, 1.8m	Unshielded, 1.8m
4	Printer	STYLUS C60	DR3K043129	FCC DoC	EPSON	Unshielded, 1.8m	Unshielded, 1.8m
5	PS/2 Keyboard	Y-SP29	SYU30272822	FCC DoC	Logitech	Shielded, 1.8m	N/A
6	PS/2 Mouse	M-S34	HCA25200458	DZL211029	Logitech	Shielded, 1.8m	N/A
7	Simulated Terminal (For EUT Used)	N/A	N/A	N/A	N/A	N/A	Unshielded, 1.5m x 2
8	DC Power Supply (For Simulated Terminal Used)	DC100-30D	N/A	N/A	ALL POWER	N/A	AC I/P: Unshielded, 1.8m

Note: All the above equipment/cables were placed in worse case positions to maximize emission signals during emission test.

Grounding: Grounding was in accordance with the manufacturer's requirements and conditions for the intended use.

5 FACILITIES AND ACCREDITATIONS







5.1 FACILITIES

All measurement facilities used to collect the measurement data are located at CCS Taiwan Linkou Lab at No. 81-1, Lane 210, Bade Rd., 2, Luchu Hsiang, Taoyuan Hsien, Taiwan.

The measurement facilities are constructed in conformance with the requirements of CISPR 16-1, ANSI C63.4 and other equivalent standards.

5.2 LABORATORY ACCREDITATIONS AND LISTINGS

The test facilities used to perform Electromagnetic compatibility tests are registered or accredited by the organizations listed in the following table which includes the recognized scope specifically.

Country	Agency	Scope of Accreditation	Logo
USA	NVLAP	EN 55011, EN 55014-1, AS/NZS 1044, CNS 13783-1, EN 55022, CNS 13438, EN 61000-3-2, EN 61000-3-3, ANSI C63.4, FCC OST/MP-5, AS/NZS CISPR 22, IEC 61000-4-2, IEC 61000-4-3, IEC 61000-4-4, IEC 61000-4-5, IEC 61000-4-6, IEC 61000-4-8, IEC 61000-4-11	 Lab. Code:200600-0
USA	FCC	3/10 meter Open Area Test Sites to perform FCC Part 15/18 measurements	 93105, 90471
Japan	VCCI	3/10 meter Open Area Test Sites and conducted test sites to perform radiated/conducted measurements	 R-393/1066/725/879/1868 C-402/747/912
Norway	NEMKO	EN 50081-1/2, EN 50082-1/2, IEC 61000-6-1/2, EN 50091-2, EN 50130-4, EN 55011, EN 55013, EN 55014-1/2, EN 55015, EN 55022, EN 55024, EN 61000-3-2/3, EN 61326-1, IEC 61000-4-2/3/4/5/6/8/11, EN 60601-1-2, EN 300 328-2, EN 300 422-2, EN 301 419-1, EN 301 489-01/03/07/08/09/17, EN 301 419-2/3, EN 300 454-2, EN 301 357-2	 ELA 124a ELA 124b ELA 124c
Taiwan	CNLA	EN 300 328-1, EN 300 328-2, EN 300 220-1, EN 300 220-2, EN 300 220-3, 47 CFR FCC Part 15 Subpart C, EN 61000-3-2, EN 61000-3-3, CNS 13439, CNS 13783-1, CNS 14115, CNS 13438, AS/NZS CISPR 22, CNS 13022-1, IEC 61000-4-2/3/4/5/6/8/11, CNS 13022-2/3	 0 3 6 3 ILAC MRA
Taiwan	BSMI	CNS 13438, CNS 13783-1, CNS 13439, CNS 14115	 SL2-IS-E-0014 / IN-E-0014 /A1-E-0014 /R1-E-0014 /R2-E-0014 /L1-E-0014
Canada	Industry Canada	RSS212, Issue 1	 IC 3991-3 IC 3991-4

Note: No part of this report may be used to claim or imply product endorsement by CNLA, NVLAP or other government agency.



6 INSTRUMENT AND CALIBRATION

6.1 MEASURING INSTRUMENT CALIBRATION

The measuring equipment utilized to perform the tests documented in this report has been calibrated once a year or in accordance with the manufacturer's recommendations, and is traceable under the IEC 17025 to international or national standards. Equipment has been calibrated by accredited calibration laboratories.

6.2 TEST AND MEASUREMENT EQUIPMENT

The following list contains measurement equipment used for testing. The equipment conforms to the requirement of CISPR 16-1, ANSI C63.2 and other required standards.

Calibration of all test and measurement, including any accessories that may effect such calibration, is checked frequently to ensure the accuracy. Adjustments are made and correction factors are applied in accordance with the instructions contained in the respective manual.

Equipment Used for Emission Measurement

Open Area Test Site # 5				
Name of Equipment	Manufacturer	Model	Serial Number	Calibration Due
Bilog Antenna	SCHWAZBECK	VULB9163	128	01/16/2005
Spectrum Analyzer	ADVANTEST	R3132	91700456	N.C.R
EMI Test Receiver	R&S	ESVS10	846285/016	04/25/2005
Turn Table	CCS	CC-T-1F	N/A	N.C.R
Antenna Tower	CCS	CC-A-1F	N/A	N.C.R
Controller	CCS	CC-C-1F	04	N.C.R
RF Switch	ANRITSU	MP59B	10877	N.C.R
Site NSA	CCS	N/A	N/A	12/17/2005

Note: The measurement uncertainty is less than +/- 3.36dB, which is evaluated as per the NAMAS NIS 81 and CISPR/A/291/CDV.

**Equipment Used for Immunity Measurement**

ESD Test Site (IEC/EN 61000-4-2)				
Name of Equipment	Manufacturer	Model	Serial Number	Calibration Due
ESD Generator	EM TEST	P30C	0603-01	08/01/2005

Radiated Electromagnetic Field Immunity Test Site (IEC/EN 61000-4-3)				
Name of Equipment	Manufacturer	Model	Serial Number	Calibration Due
S.G.	R&S	SMY02	100094	08/05/2005
Power Meter	R&S	NRVD	837794/029	08/06/2005
Power Sensor	R&S	URV5-Z2	835640/015	08/06/2005
Power Sensor	R&S	URV5-Z2	835640/016	08/06/2005
Power Amplifier	ar	150W1000	300300	N.C.R

Fast Transients/Burst Test Site (IEC/EN 61000-4-4)				
Name of Equipment	Manufacturer	Model	Serial Number	Calibration Due
Fast Transients/Burst Generator	HAEFELY TRENCH	PEFT- JUNIOR	583 333-117	08/25/2005
Clamp	HAEFELY TRENCH	093 506.1	080 421.13	N.C.R

Surge Immunity Test Site (IEC/EN 61000-4-5)				
Name of Equipment	Manufacturer	Model	Serial Number	Calibration Due
Surge Tester	HAEFELY TRENCH	PSUGER 4010	583 334-71	08/25/2005



CS Test Site (IEC/EN 61000-4-6)				
Name of Equipment	Manufacturer	Model	Serial Number	Calibration Due
S.G.	R&S	SMY02	100094	08/05/2005
Power Meter	R&S	NRVD	837794/029	08/06/2005
Power Sensor	R&S	URV5-Z2	835640/015	08/06/2005
Power Sensor	R&S	URV5-Z2	835640/016	08/06/2005
Power Amplifier	ar	500A100A	300299	N.C.R
CDN	Lüthi	801-M3	1879	03/03/2005
CDN	FRANKONIA	CDN-M2	A3002010	08/06/2005
CDN	SCHAFFNER	T400	16906	12/28/2004

Power Frequency Magnetic Field Immunity Test Site (IEC/EN 61000-4-8)				
Name of Equipment	Manufacturer	Model	Serial Number	Calibration Due
TRIAx ELF Magnetic Field Meter	F.W.BELL	4090	9711	11/21/2005
Clamp Meter	National	300K	11-5980 K	11/28/2005
Magnetic Field Tester	HAEFELY TRENCH	MAG 100.1	080 938-01	N.C.R



7 LINE CONDUCTED & RADIATED EMISSION TEST

7.1 LIMIT

Maximum permissible level of Line Conducted Emission

Frequency (MHZ)	Class A (dBuV)		Class B (dBuV)	
	Quasi-peak	Average	Quasi-peak	Average
0.15 - 0.5	79	66	66 - 56	56 - 46
0.50 - 5.0	73	60	56	46
5.0 - 30.0	73	60	60	50

Note: The lower limit shall apply at the transition frequency.

Maximum permissible level of Common Mode Conducted Emission (Telecommunication Ports)

CLASS A

Frequency (MHZ)	Voltage Limit (dBuV)		Current Limit (dBuA)	
	Quasi-peak	Average	Quasi-peak	Average
0.15 - 0.5	97 - 87	84 - 74	53 - 43	40 - 30
0.5 - 30.0	87	74	43	30

Note: The lower limit shall apply at the transition frequency.

CLASS B

Frequency (MHZ)	Voltage Limit (dBuV)		Current Limit (dBuA)	
	Quasi-peak	Average	Quasi-peak	Average
0.15 - 0.5	84 - 74	74 - 64	40 - 30	30 - 20
0.5 - 30.0	74	64	30	20

Note: The lower limit shall apply at the transition frequency.

Maximum permissible level of Radiated Emission measured at 10 meter

Frequency (MHZ)	Class A (dBuV/m)	Class B (dBuV/m)
	Quasi-peak	Quasi-peak
30 - 230	40	30
230 - 1000	47	37

Note: The lower limit shall apply at the transition frequency.



7.2 TEST PROCEDURE OF LINE CONDUCTED EMISSION

Procedure of Preliminary Test

- The EUT was set up as per the test configuration to simulate typical usage per the user's manual. When the EUT is a tabletop system, a wooden table with a height of 0.8 meters is used and is placed on the ground plane as per EN 55022 (see Test Facility for the dimensions of the ground plane used). When the EUT is a floor-standing equipment, it is placed on the ground plane which has a 3-12 mm non-conductive covering to insulate the EUT from the ground plane.
- Support equipment, if needed, was placed as per EN 55022.
- All I/O cables were positioned to simulate typical actual usage as per EN 55022.
- The test equipment EUT installed received AC power, 230VAC/50Hz, through a Line Impedance Stabilization Network (LISN), which supplied power source and was grounded to the ground plane.
- All support equipment received power from a second LISN.
- The EUT test program was started. Emissions were measured on each current carrying line of the EUT using an EMI Test Receiver connected to the LISN powering the EUT.
- The Receiver scanned from 150kHz to 30MHz for emissions in each of the test modes.
- During the above scans, the emissions were maximized by cable manipulation.
- The test mode(s) described in Item 3.2 were scanned during the preliminary test.
- After the preliminary scan, we found the test mode described in Item 3.2 producing the highest emission level.
- The EUT configuration and cable configuration of the above highest emission level were recorded for reference of the final test.

Procedure of Final Test

- EUT and support equipment were set up on the test bench as per the configuration with highest emission level in the preliminary test.
- A scan was taken on both power lines, Line 1 and Line 2, recording at least the six highest emissions. Emission frequency and amplitude were recorded into a computer in which correction factors were used to calculate the emission level and compare reading to the applicable limit. If EUT emission level was less -2dB to the Average limit in Q.P. mode, then the emission signal was re-checked using an Average detector.
- The test data of the worst-case condition(s) was recorded.



Data Sample:

Freq. (MHz)	Q.P. Raw (dBuV)	Average Raw (dBuV)	Q.P. Limit (dBuV)	Average Limit (dBuV)	Q.P. Margin (dB)	Average Margin (dB)	Note
x.xx	43.95	---	73.00	60.00	-29.05	---	L1

- Freq. = Emission frequency in MHz
- Raw dBuV = Uncorrected Analyzer/Receiver reading + Insertion loss of LISN, if it > 0.5 dB
- Limit dBuV = Limit stated in standard
- Margin dB = Reading in reference to limit
- Note = Current carrying line of reading
- “---“ = The emission level complied with the Average limits, with at least 2dB margin limits, so no further recheck.

Calculation Formula

$$\text{Margin (dB)} = \text{RAW (dBuV)} - \text{Limit (dBuV)}$$

7.3 TEST PROCEDURE OF COMMON MODE CONDUCTED EMISSION FOR TELECOMMUNICATION PORT

- Selecting ISN for unscreened cable or a current probe for screened cable to take measurement.
- The port of the EUT was connected to the remote side support equipment through the ISN/Current Probe and communication in normal condition.
- Making a overall range scan by using the test receiver controlled by controller and record at least six highest emissions for showing in the test report.
- Emission frequency and amplitude were recorded into a computer in which correction factors were used to calculate the emission level and compare reading to the applicable limit.
- In case of measuring on the screened cable, the current limit shall be applied, otherwise the voltage limit should be applied.
- The following test mode(s) were scanned during the preliminary test:

Not applicable, the conducted emission test item for telecom ports disturbance voltage is not tested in this report as per client's request.

**Data Sample:**

Freq. (MHz)	Q.P. Raw (dBuV)	AV. Raw (dBuV)	Q.P. Limit (dBuV)	AV. Limit (dBuV)	Q.P. Margin (dB)	AV. Margin (dB)	Note
x.xx	43.95	---	87.00	74.00	-43.05	---	---

Freq.: Emission frequency

Raw: Uncorrected Analyzer / Receiver reading

Limit: Limit stated in standard

Margin: Reading in reference to limit

Note: Current carrying line of reading

“-“: The emission level complied with the Average limits, with at least 2 dB margin, so no further recheck.

7.4 TEST PROCEDURE OF RADIATED EMISSION

Procedure of Preliminary Test

- The equipment was set up as per the test configuration to simulate typical usage per the user's manual. When the EUT is a tabletop system, a wooden turntable with a height of 0.8 meters is used which is placed on the ground plane. When the EUT is a floor-standing equipment, it is placed on the ground plane which has a 3-12 mm non-conductive covering to insulate the EUT from the ground plane.
- Support equipment, if needed, was placed as per EN 55022.
- All I/O cables were positioned to simulate typical usage as per EN 55022.
- The EUT received AC power source, 230VAC/50Hz, from the outlet socket under the turntable. All support equipment received power from another socket under the turntable.
- The antenna was placed at 10 meter away from the EUT as stated in EN 55022. The antenna connected to the Spectrum Analyzer via a cable and at times a pre-amplifier would be used.
- The Analyzer / Receiver quickly scanned from 30MHz to 1000MHz. The EUT test program was started. Emissions were scanned and measured rotating the EUT to 360 degrees and positioning the antenna 1 to 4 meters above the ground plane, in both the vertical and the horizontal polarization, to maximize the emission reading level.
- The test mode(s) described in Item 3.2 were scanned during the preliminary test:
- After the preliminary scan, we found the test mode described in Item 3.2 producing the highest emission level.
- The EUT and cable configuration, antenna position, polarization and turntable position of the above highest emission level were recorded for the final test.



Procedure of Final Test

- EUT and support equipment were set up on the turntable as per the configuration with highest emission level in the preliminary test.
- The Analyzer / Receiver scanned from 30MHz to 1000MHz. Emissions were scanned and measured rotating the EUT to 360 degrees, varying cable placement and positioning the antenna 1 to 4 meters above the ground plane, in both the vertical and the horizontal polarization, to maximize the emission reading level.
- Recorded at least the six highest emissions. Emission frequency, amplitude, antenna position, polarization and turntable position were recorded into a computer in which correction factors were used to calculate the emission level and compare reading to the applicable limit and only Q.P. reading is presented.
- The test data of the worst-case condition(s) was recorded.

Data Sample:

Freq. (MHz)	Raw Data (dBuV)	Corr. Factor (dB/m)	Emiss. Level (dBuV/m)	Limits (dBuV/m)	Margin (dB)
xx.xx	14.00	12.20	26.20	40.00	-13.80

- Freq. = Emission frequency in MHz
- Raw Data (dBuV) = Uncorrected Analyzer / Receiver reading
- Corr. Factor (dB/m) = Antenna factor + Cable loss – Amplifier gain
- Emiss. Level (dBuV/m) = Raw reading converted to dBuV/m and CF added
- Limit (dBuV/m) = Limit stated in standard
- Margin (dB) = Reading in reference to limit
- P = Peak Reading
- Q = Quasi-peak Reading
- A = Average Reading

Calculation Formula

Margin (dB) = Emiss. Level (dBuV/m) – Limits (dBuV/m)
Emission Level (dBuV/m) = Raw Data (dBuV) + Corr. Factor (dB/m)



7.5 TEST RESULTS

Line Conducted Emission

Model: N/A

Test Mode: N/A

Temperature: N/A

Humidity: N/A

Tested by: N/A

Test Results: N/A

****Note: This EUT has not connection to AC Source direct. No applicable for this test.**

Common Mode Conducted Emission

Not applicable



Radiated Emission (A)

Model: ADAM-6066

Test Mode: Mode 1

Temperature: 24°C

Humidity: 61% RH

Detector Function: Quasi-peak.

Antenna: Vertical at 10m

Tested by: Grant Chen

Test Results: Pass

(The chart below shows the highest readings taken from the final data)

Freq. (MHz)	Raw Data (dBuV)	Corr. Factor (dB/m)	Emiss. Level (dBuV/m)	Limits (dBuV/m)	Margin (dB)
110.29	7.1	12.7	19.8	40.0	-20.2
142.36	13.5	9.7	23.2	40.0	-16.8
162.52	13.0	10.5	23.5	40.0	-16.5
262.10	8.5	15.1	23.6	47.0	-23.4
322.00	4.7	16.9	21.6	47.0	-25.4
477.35	5.2	20.4	25.6	47.0	-21.4
639.80	4.6	23.4	28.0	47.0	-19.0
732.20	4.4	24.8	29.2	47.0	-17.8



Radiated Emission (B)

Model: ADAM-6066

Test Mode: Mode 1

Temperature: 24°C

Humidity: 61% RH

Detector Function: Quasi-peak.

Antenna: Horizontal at 10m

Tested by: Grant Chen

Test Results: Pass

(The chart below shows the highest readings taken from the final data)

Freq. (MHz)	Raw Data (dBuV)	Corr. Factor (dB/m)	Emiss. Level (dBuV/m)	Limits (dBuV/m)	Margin (dB)
132.56	10.6	10.3	20.9	40.0	-19.1
152.16	14.2	10.0	24.2	40.0	-15.8
165.22	9.9	10.7	20.6	40.0	-19.4
235.80	8.3	14.2	22.5	47.0	-24.5
374.90	9.0	18.3	27.3	47.0	-19.7
466.20	2.8	20.1	22.9	47.0	-24.1
564.80	4.5	22.4	26.9	47.0	-20.1
805.30	5.7	26.1	31.8	47.0	-15.2



8 POWER HARMONICS TEST

Port : AC mains
Basic Standard : EN 61000-3-2 (2000)
Limits : CLASS A ; CLASS B ; CLASS C ; CLASS D
Tested by : N/A
Temperature : N/A
Humidity : N/A

Limit:

Limits for Class A equipment		Limits for Class D equipment		
Harmonics Order n	Max. permissible harmonics current A	Harmonics Order n	Max. permissible harmonics current per watt mA/W	Max. permissible harmonics current A
Odd harmonics		Odd Harmonics only		
3	2.30	3	3.4	2.30
5	1.14	5	1.9	1.14
7	0.77	7	1.0	0.77
9	0.40	9	0.5	0.40
11	0.33	11	0.35	0.33
13	0.21	13	0.30	0.21
15<=n<=39	0.15x15/n	15<=n<=39	3.85/n	0.15x15/n
Even harmonics				
2	1.08			
4	0.43			
6	0.30			
8<=n<=40	0.23x8/n			

Block Diagram of Test Setup:

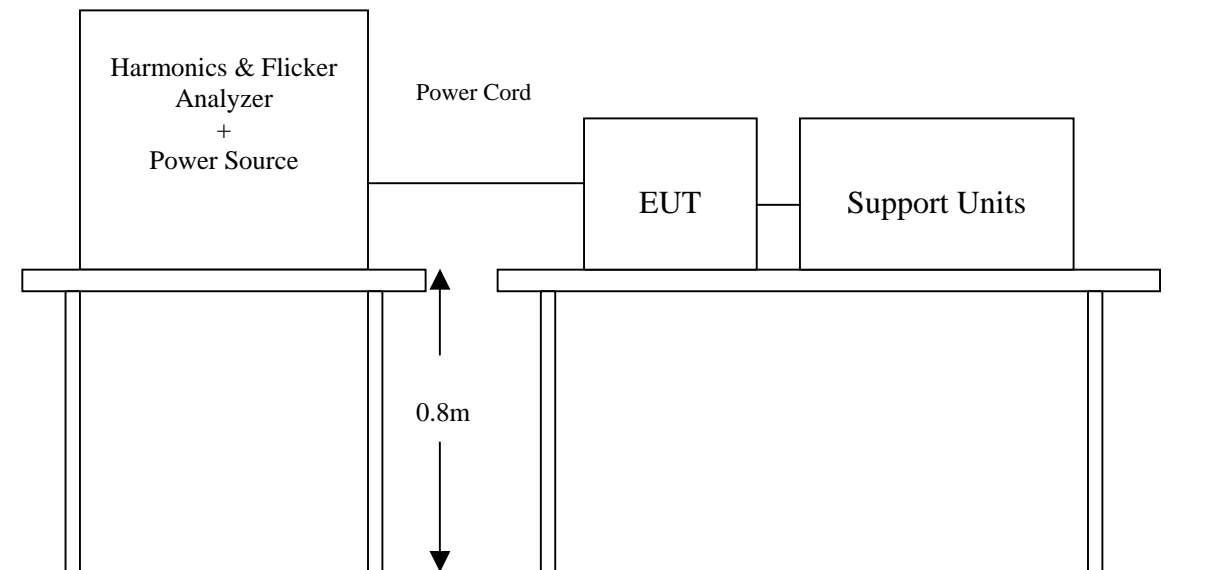

Test Procedure:

- a. The EUT was placed on the top of a wooden table 0.8 meters above the ground and operated to produce the maximum harmonic components under normal operating conditions for each successive harmonic component in turn.
- b. The correspondent test program of test instrument to measure the current harmonics emanated from EUT is chosen. The measure time shall be not less than the time necessary for the EUT to be exercised.

Test Result :

Not applicable, because EUT not connect to AC Main Source direct.

9 POWER VOLTAGE FLUCTUATION / FLICKER TEST

Port : AC mains
Basic Standard : EN 61000-3-3 (1995 + A1: 2001)
Limits : §5 of EN 61000-3-3
Tested by : N/A
Temperature : N/A
Humidity : N/A

Limit:

TEST ITEM	LIMIT	REMARK
P_{st}	1.0	P_{st} means short-term flicker indicator.
P_{lt}	0.65	P_{lt} means long-term flicker indicator.
T_{dt} (ms)	500	T_{dt} means maximum time that dt exceeds 3 %.
d_{max} (%)	4%	d_{max} means maximum relative voltage change.
dc (%)	3.3%	dc means relative steady-state voltage change

Block Diagram of Test Setup:

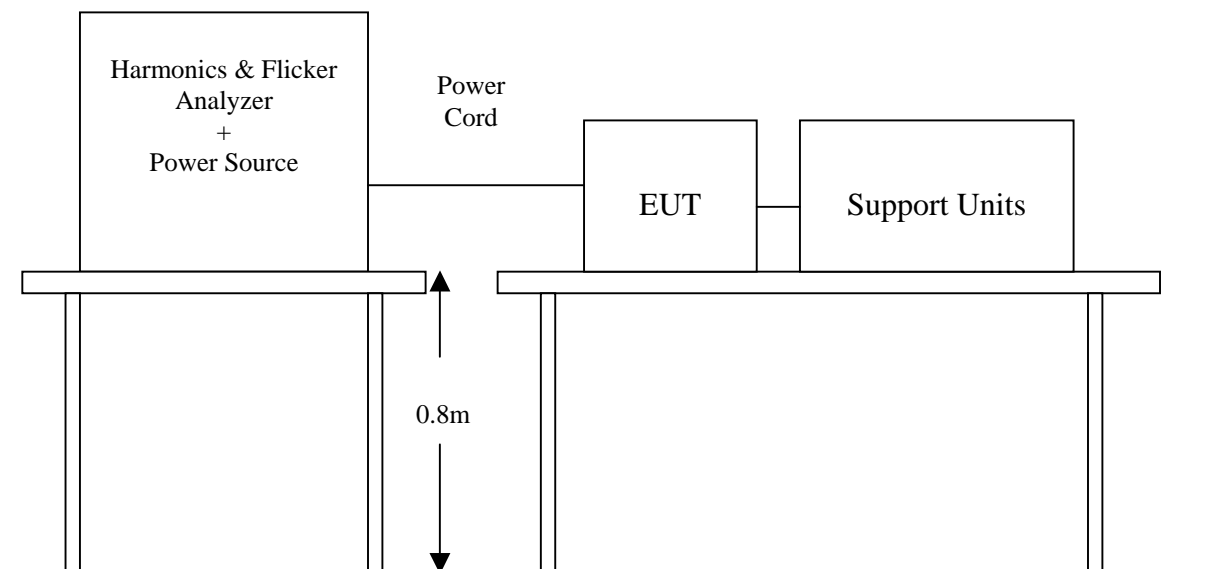



Test Procedure:

- a. The EUT was placed on the top of a wooden table 0.8 meters above the ground and operated to produce the most unfavorable sequence of voltage changes under normal operating conditions.
- b. During the flick measurement, the measure time shall include that part of whole operation cycle in which the EUT produce the most unfavorable sequence of voltage changes. The observation period for short-term flicker indicator is 10 minutes and the observation period for long-term flicker indicator is 2 hours.

Test Result :

Not applicable, because EUT not connect to AC Main Source direct.

10 ELECTROSTATIC DISCHARGE (ESD) IMMUNITY TEST

Port	: Enclosure
Basic Standard	: IEC/EN 61000-4-2
Test Level	: ± 8 kV (Air Discharge) ± 4 kV (Contact Discharge) ± 4 kV (Indirect Discharge)
Performance Criterion	: B (Standard Required)
Tested by	: Ethan Huang
Temperature	: 25°C
Humidity	: 54% RH
Pressure	: 1019mbar

Block Diagram of Test Setup:

(The 470 k ohm resistors are installed per standard requirement.)

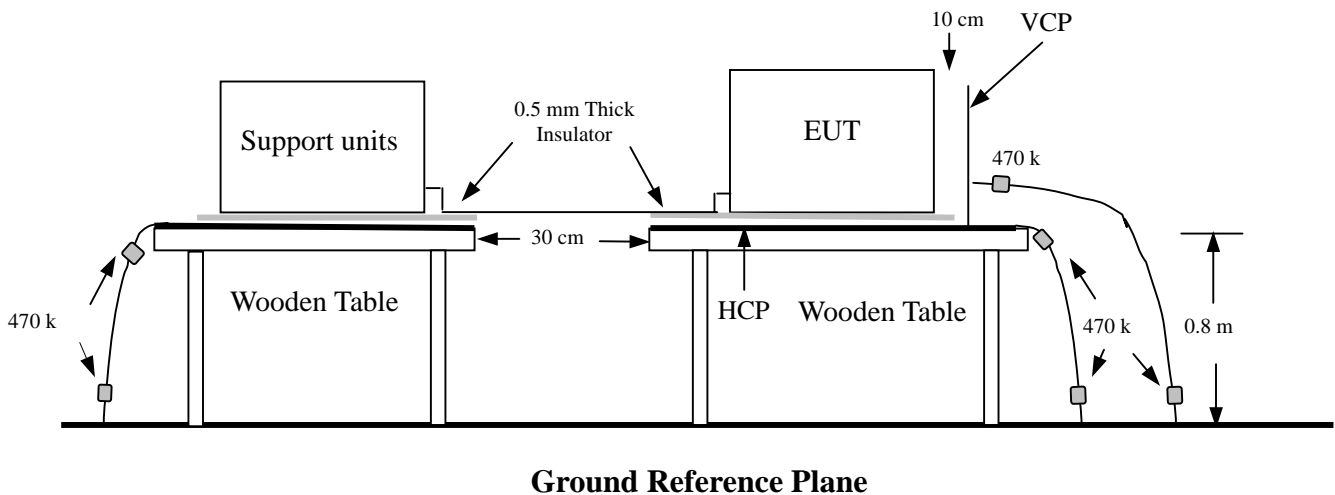



Test Procedure:

1. The EUT was located 0.1 m minimum from all side of the HCP.
2. The indirect support units were located 1 m minimum away from the EUT, but direct support unit was/were located at same location as EUT on the HCP and keep at a distance of 10 cm with EUT.
3. A scroll ‘H’ test program was loaded and executed in Windows XP mode.
4. The Host sent above message to monitor and related peripherals through the test.
5. Active the communication function if the EUT with such port(s).
6. As per the requirement of EN 55024; applying direct contact discharge at the sides other than front of EUT at minimum 50 discharges (25 positive and 25 negative) if applicable, can’t be applied direct contact discharge side of EUT then the indirect discharge shall be applied. One of the test points shall be subjected to at least 50 indirect discharge (contact) to the front edge of horizontal coupling plane.
7. Other parts of EUT where it is not possible to perform contact discharge then selecting appropriate points of EUT for air discharge, a minimum of 10 single air discharges shall be applied.
8. The application of ESD to the contact of open connectors is not required.
9. The EUT direct connection units also need to be applied ESD at the port of EUT cable connected.
10. Putting a mark on EUT to show tested points. The following test condition was followed during the tests.

Note: As per IEC/EN 61000-4-2, two 470k bleed resistors cable is connected between the EUT and HCP during the test applicable for power ungrounded or battery operating unit only.

The electrostatic discharges were applied as follows:

Amount of discharge	Voltage	Coupling	Result (Pass/Fail)
Mini 10 /Point	± 8 kV	Air Discharge	Pass
Mini 25 /Point	± 4 kV	Contact Discharge	Pass
Mini 25 /Point	± 4 kV	Indirect Discharge HCP	Pass
Mini 25 /Point	± 4 kV	Indirect Discharge VCP (Right)	Pass
Mini 25 /Point	± 4 kV	Indirect Discharge VCP (Left)	Pass

For the tested points to EUT, please refer to attached page.
(Blue arrow mark for Contact Discharge and red arrow mark for Air Discharge)



Performance & Result:

- Criteria A:** The apparatus continues to operate as intended. No degradation of performance or loss of function is allowed below a performance level specified by the manufacturer, when the apparatus is used as intended. In some cases the performance level may be replaced by a permissible loss of performance.

- Criteria B:** The apparatus continues to operate as intended after the test. No degradation of performance or loss of function is allowed below a performance level specified by the manufacturer, when the apparatus is used as intended. In some cases the performance level may be replaced by a permissible loss of performance. During the test, degradation of performance is however allowed.

- Criteria C:** Temporary loss of function is allowed, provided the functions self recoverable or can be restored by the operation of controls.

<input checked="" type="checkbox"/> PASS <input type="checkbox"/> FAIL
Observation: No function degraded during the tests.

The Tested Points of EUT

Photo 1 of 3



Photo 2 of 3





Photo 3 of 3



11 RADIATED ELECTROMAGNETIC FIELD IMMUNITY TEST

Port	: Enclosure
Basic Standard	: IEC/EN 61000-4-3
Requirements	: 10 V/m / with 80% AM. 1kHz Modulation. (Customer Required)
Performance Criterion	: A (Standard Required)
Tested by	: Ethan Huang
Temperature	: 23°C
Humidity	: 52% RH
Pressure	: 1019mbar

Block Diagram of Test Setup:

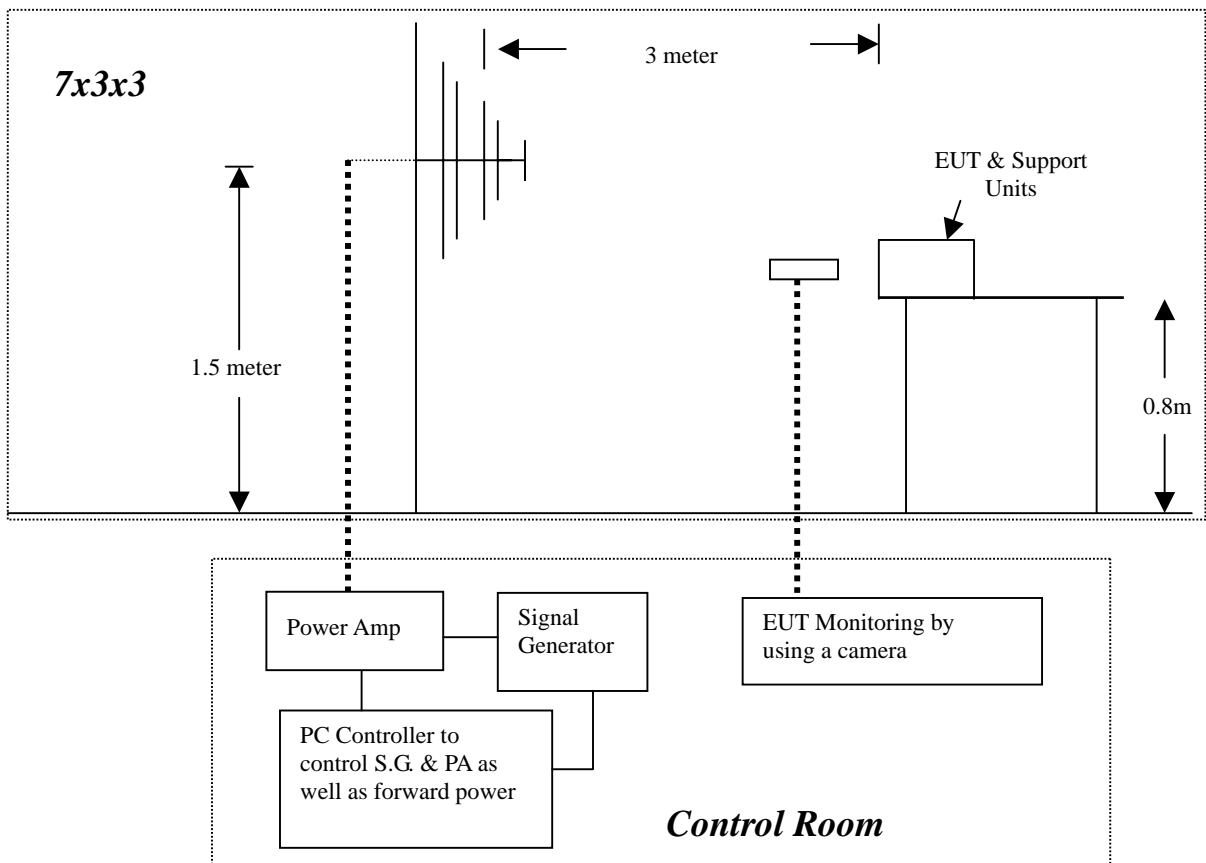

**Test Procedure:**

1. The EUT was located at the edge of supporting table keep 3 meter away from transmitting antenna, it just the calibrated square area of field uniformity. The support units were located outside of the uniformity area, but the cable(s) connected with EUT were exposed to the calibrated field as per IEC/EN 61000-4-3.
2. Setting the testing parameters of RS test software per IEC/EN 61000-4-3.
3. Performing the pre-test at each side of with double specified level (6V/m) at 4% steps.
4. From the result of pre-test in step 5, choice the worst side of EUT for final test from 80 MHz to 1000 MHz at 1% steps.
5. Recording the test result in following table.
6. It is not necessary to perform test as per annex A of EN 55024 if the EUT doesn't belong to ITE product.

Preliminary test conditions:

Test level : 10V/m
 Steps : 4 % of fundamental
 Dwell Time : 3 sec

Range (MHz)	Field	Modulation	Polarity	Position	Result (Pass/Fail)
80-1000	6V/m	Yes	H	Front	Pass
80-1000	6V/m	Yes	V	Front	Pass
80-1000	6V/m	Yes	H	Right	Pass
80-1000	6V/m	Yes	V	Right	Pass
80-1000	6V/m	Yes	H	Back	Pass
80-1000	6V/m	Yes	V	Back	Pass
80-1000	6V/m	Yes	H	Left	Pass
80-1000	6V/m	Yes	V	Left	Pass

Final test conditions:

Test level : 10V/m
 Steps : 1 % of fundamental
 Dwell Time : 3 sec

Range (MHz)	Field	Modulation	Polarity	Position	Result (Pass/Fail)
80-1000	3V/m	Yes	H	Back	Pass
80-1000	3V/m	Yes	V	Back	Pass



Performance & Result:

- Criteria A:** The apparatus continues to operate as intended. No degradation of performance or loss of function is allowed below a performance level specified by the manufacturer, when the apparatus is used as intended. In some cases the performance level may be replaced by a permissible loss of performance.
- Criteria B:** The apparatus continues to operate as intended after the test. No degradation of performance or loss of function is allowed below a performance level specified by the manufacturer, when the apparatus is used as intended. In some cases the performance level may be replaced by a permissible loss of performance. During the test, degradation of performance is however allowed.
- Criteria C:** Temporary loss of function is allowed, provided the functions self recoverable or can be restored by the operation of controls.

<input checked="" type="checkbox"/> PASS <input type="checkbox"/> FAIL
Observation: No function degraded during the tests.

12 FAST TRANSIENTS/BURST IMMUNITY TEST

Port	: d.c. Input Power Port and LAN Cable
Basic Standard	: IEC/EN 61000-4-4
Requirements	: ± 2 kV for Power Supply Line (Customer Required) ± 1 kV for LAN Cable (Customer Required)
Performance Criteria	: B (Standard Required)
Tested by	: Ethan Huang
Temperature	: 25°C
Humidity	: 54% RH
Pressure	: 1019mbar

Block Diagram of Test Setup:

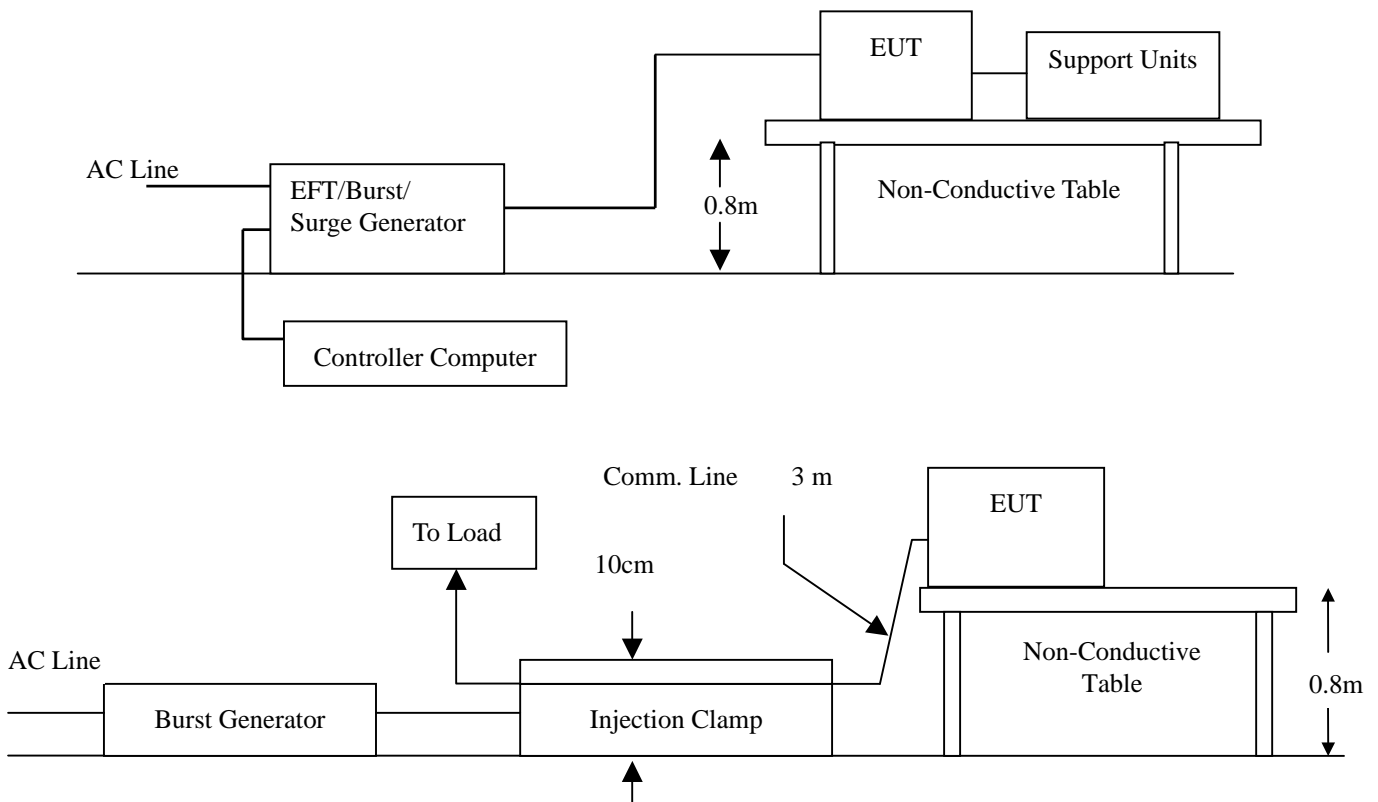

Test Procedure:

1. The EUT and support units were located on a wooden table 0.8 m away from ground reference plane.
2. A 1.0 meter long power cord was attached to EUT during the test.
3. The length of communication cable between communication port and clamp was keeping within 1 meter.
4. Injected test voltage to the EUT ports from minimum to standard request or client request.
5. Recording the test result as shown in following table.



Test conditions:

Impulse Frequency : 5kHz
Tr/Th : 5/50ns
Burst Duration : 15ms
Burst Period : 3Hz

Inject Line	Voltage kV	Inject Method	Result (Pass/Fail)
L	± 2	Direct	Pass
N	± 2	Direct	Pass
L + N	± 2	Direct	Pass
RJ 45 Port (LAN Cable)	± 1	Clamp	Pass

Performance & Result:

- Criteria A:** The apparatus continues to operate as intended. No degradation of performance or loss of function is allowed below a performance level specified by the manufacturer, when the apparatus is used as intended. In some cases the performance level may be replaced by a permissible loss of performance.
- Criteria B:** The apparatus continues to operate as intended after the test. No degradation of performance or loss of function is allowed below a performance level specified by the manufacturer, when the apparatus is used as intended. In some cases the performance level may be replaced by a permissible loss of performance. During the test, degradation of performance is however allowed.
- Criteria C:** Temporary loss of function is allowed, provided the functions self recoverable or can be restored by the operation of controls.

<input checked="" type="checkbox"/> PASS <input type="checkbox"/> FAIL
--

<p>Observation: No function degraded during the tests.</p>

13 SURGE IMMUNITY TEST

Port	: d.c. Power Port and LAN Cable
Basic Standard	: IEC/EN 61000-4-5
Requirements	: ± 0.5 kV (Line to Line) (Customer Required)
Performance Criteria	: B (Standard Required)
Tested by	: Ethan Huang
Temperature	: 25°C
Humidity	: 54% RH
Pressure	: 1019mbar

Block Diagram of Test Setup:

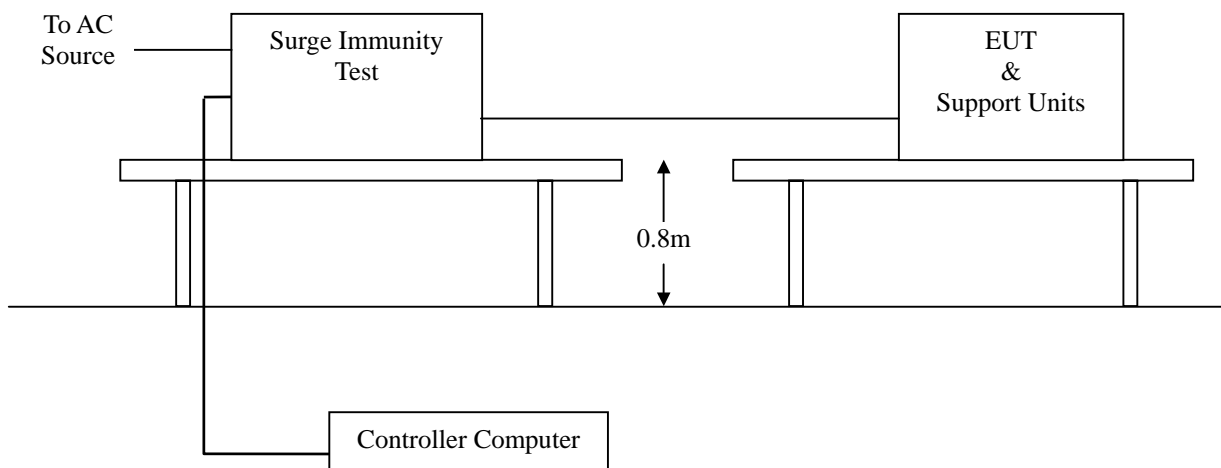

Test Procedure:

1. The EUT and support units were located on a wooden table 0.8 m away from ground floor.
2. Injected test voltage to the EUT ports from minimum to standard request or client request.
3. Recording the test result as shown in following table.



Test conditions:

Voltage Waveform : 1.2/50 us
 Current Waveform : 8/20 us
 Polarity : Positive/Negative
 Phase angle : 0°, 90°, 270°
 Number of Test : 5

Coupling Line	Voltage (kV)	Polarity	Coupling Method	Result (Pass/Fail)
L1-L2	0.5	Positive	Capacitive	Pass
L1-L2	0.5	Negative	Capacitive	Pass

Performance & Result:

- Criteria A:** The apparatus continues to operate as intended. No degradation of performance or loss of function is allowed below a performance level specified by the manufacturer, when the apparatus is used as intended. In some cases the performance level may be replaced by a permissible loss of performance.
- Criteria B:** The apparatus continues to operate as intended after the test. No degradation of performance or loss of function is allowed below a performance level specified by the manufacturer, when the apparatus is used as intended. In some cases the performance level may be replaced by a permissible loss of performance. During the test, degradation of performance is however allowed.
- Criteria C:** Temporary loss of function is allowed, provided the functions self recoverable or can be restored by the operation of controls.

PASS **FAIL**

Observation: No function degraded during the tests.

14 CONDUCTED DISTURBANCE/INDUCED RADIO-FREQUENCY FIELD IMMUNITY TEST

Port	: d.c. Input Power Port and LAN Cable
Basic Standard	: IEC/EN 61000-4-6
Requirements	: 10 V with 80% AM. 1kHz Modulation. (Customer Required)
Injection Method	: CDN-M2 for Power Cable CDN-T4 for LAN Cable
Performance Criterion	: A (Standard Required)
Tested by	: Ethan Huang
Temperature	: 25°C
Humidity	: 51% RH
Pressure	: 1012mbar

Block Diagram of Test Setup:

Side View:

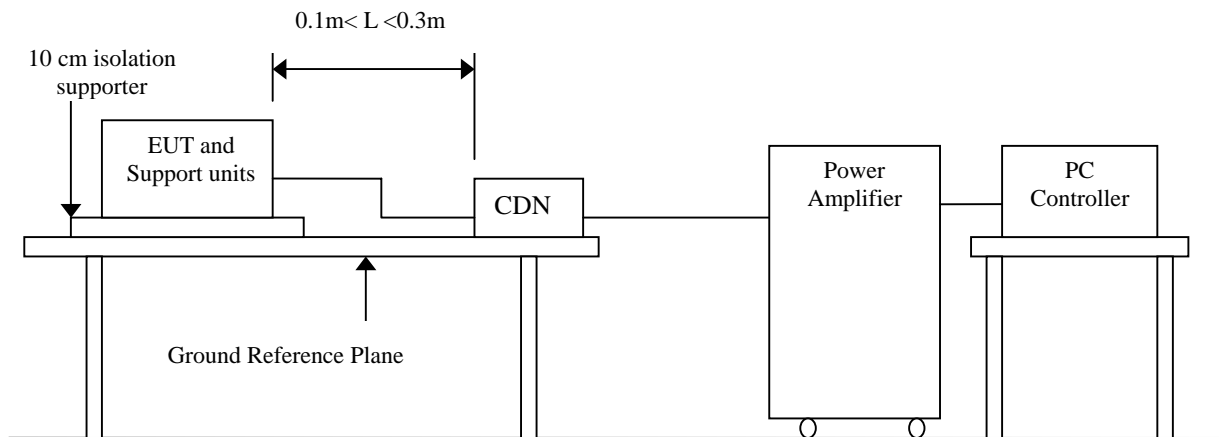

Top View:

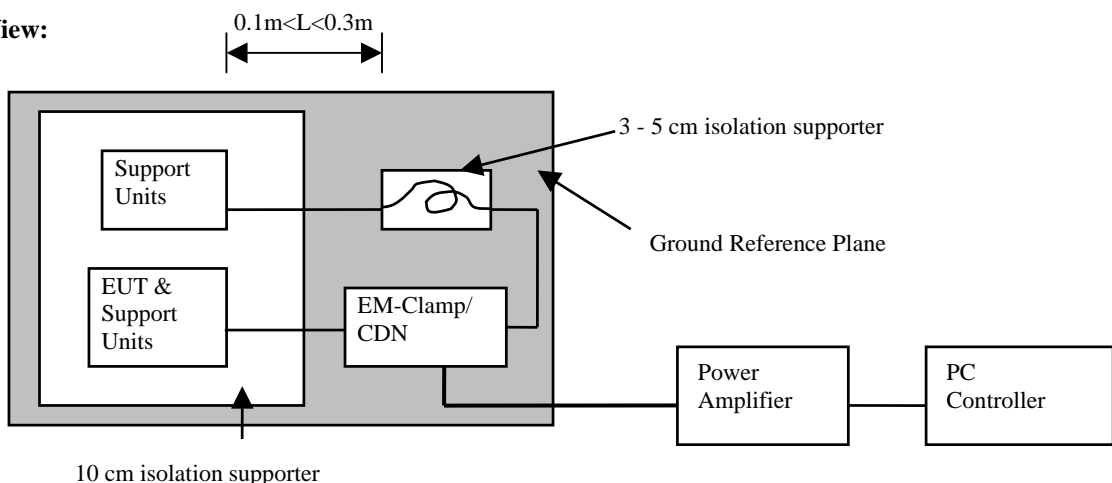



Test Procedure:

1. The EUT and support units were located at a ground reference plane with the interposition of a 0.1 m thickness insulating support and the CDN was located on GRP directly.
2. Setting the testing parameters of CS test software as per IEC/EN 61000-4-6.
3. Recording the test result in following table.

Test conditions:

Frequency Range : 0.15MHz-80MHz

Frequency Step : 1% of fundamental

Dwell Time : 3 sec

Range (MHz)	Field	Modulation	Result (Pass/Fail)
0.15-80	10V	Yes	Pass

Performance & Result:

- Criteria A:** The apparatus continues to operate as intended. No degradation of performance or loss of function is allowed below a performance level specified by the manufacturer, when the apparatus is used as intended. In some cases the performance level may be replaced by a permissible loss of performance.
- Criteria B:** The apparatus continues to operate as intended after the test. No degradation of performance or loss of function is allowed below a performance level specified by the manufacturer, when the apparatus is used as intended. In some cases the performance level may be replaced by a permissible loss of performance. During the test, degradation of performance is however allowed.
- Criteria C:** Temporary loss of function is allowed, provided the functions self recoverable or can be restored by the operation of controls.

<input checked="" type="checkbox"/> PASS <input type="checkbox"/> FAIL
Observation: No function degraded during the tests.

15 POWER FREQUENCY MAGNETIC FIELD IMMUNITY TEST

Port	: Enclosure
Basic Standard	: IEC/EN 61000-4-8
Requirements	: 30 A/m (Customer Required)
Performance Criterion	: A (Standard Required)
Tested by	: Ethan Huang
Temperature	: 25°C
Humidity	: 53% RH
Pressure	: 1019mbar

Block Diagram of Test Setup:

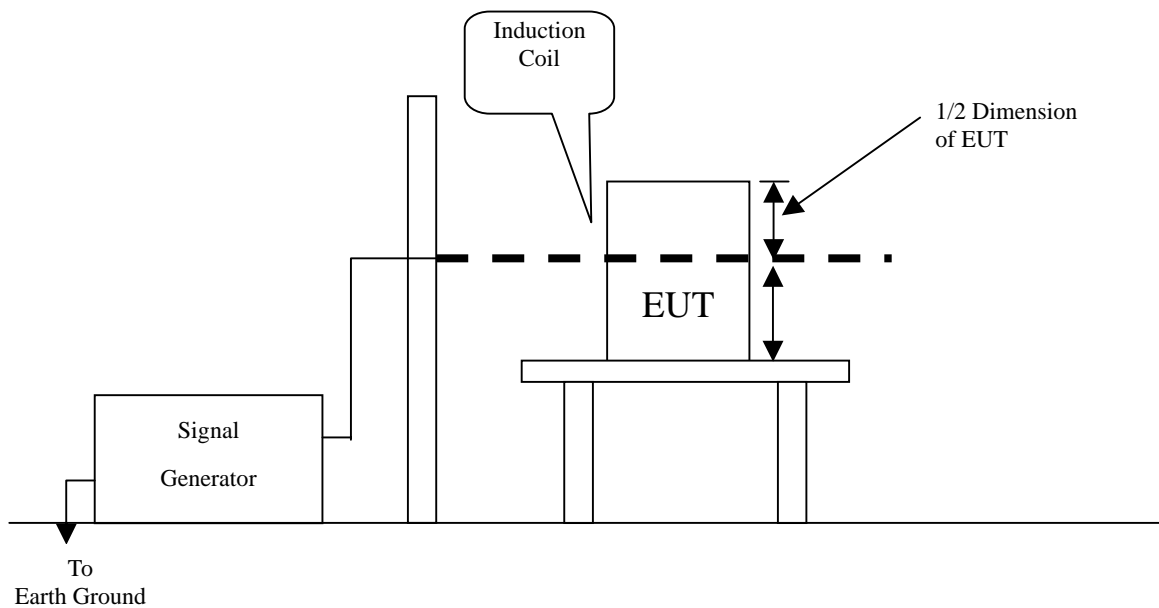

Test Procedure:

1. The EUT and support units were located on Ground Reference Plane with the interposition of a 0.1 m thickness insulation support.
2. Putting the induction coil on horizontal direction. (X direction)
3. Rotating the induction coil by 90° (Y direction)
4. Rotating the induction coil by 90° again (Z direction)
5. Recording the test result as shown in following table.



Test conditions:

Field Strength: 30A/m
Power Freq.: 50Hz
Orientation: X, Y, Z

Orientation	Field	Result (Pass/Fail)	Remark
X	30A/m	Pass	
Y	30A/m	Pass	
Z	30A/m	Pass	

Performance & Result:

- Criteria A:** The apparatus continues to operate as intended. No degradation of performance or loss of function is allowed below a performance level specified by the manufacturer, when the apparatus is used as intended. In some cases the performance level may be replaced by a permissible loss of performance.
- Criteria B:** The apparatus continues to operate as intended after the test. No degradation of performance or loss of function is allowed below a performance level specified by the manufacturer, when the apparatus is used as intended. In some cases the performance level may be replaced by a permissible loss of performance. During the test, degradation of performance is however allowed.
- Criteria C:** Temporary loss of function is allowed, provided the functions self recoverable or can be restored by the operation of controls.

<input checked="" type="checkbox"/> PASS <input type="checkbox"/> FAIL
Observation: No function degraded during the tests.



16 VOLTAGE DIPS / SHORT INTERRUPTIONS

Port : AC mains
Basic Standard : IEC/EN 61000-4-11
Requirement : PHASE ANGLE 0, 45, 90, 135, 180, 225, 270, 315 degrees
Test Interval : Min. 10 sec.
Tested by : N/A
Temperature : N/A
Humidity : N/A
Pressure : N/A

Performance & Result:

Criteria A: The apparatus continues to operate as intended. No degradation of performance or loss of function is allowed below a performance level specified by the manufacturer, when the apparatus is used as intended. In some cases the performance level may be replaced by a permissible loss of performance.

Criteria B: The apparatus continues to operate as intended after the test. No degradation of performance or loss of function is allowed below a performance level specified by the manufacturer, when the apparatus is used as intended. In some cases the performance level may be replaced by a permissible loss of performance. During the test, degradation of performance is however allowed.

Criteria C: Temporary loss of function is allowed, provided the functions self recoverable or can be restored by the operation of controls.

PASS **FAIL**

Not applicable, because EUT not connect to AC Main Source direct.

APPENDIX I - PHOTOGRAPHS OF TEST SETUP

RADIATED EMISSION TEST (EN 55022)



ELECTROSTATIC DISCHARGE TEST



RADIATED ELECTROMAGNETIC FIELD TEST



FAST TRANSIENTS/BURST TEST





SURGE IMMUNITY TEST



CONDUCTED DISTURBANCE, INDUCED BY RADIO-FREQUENCY FIELDS TEST

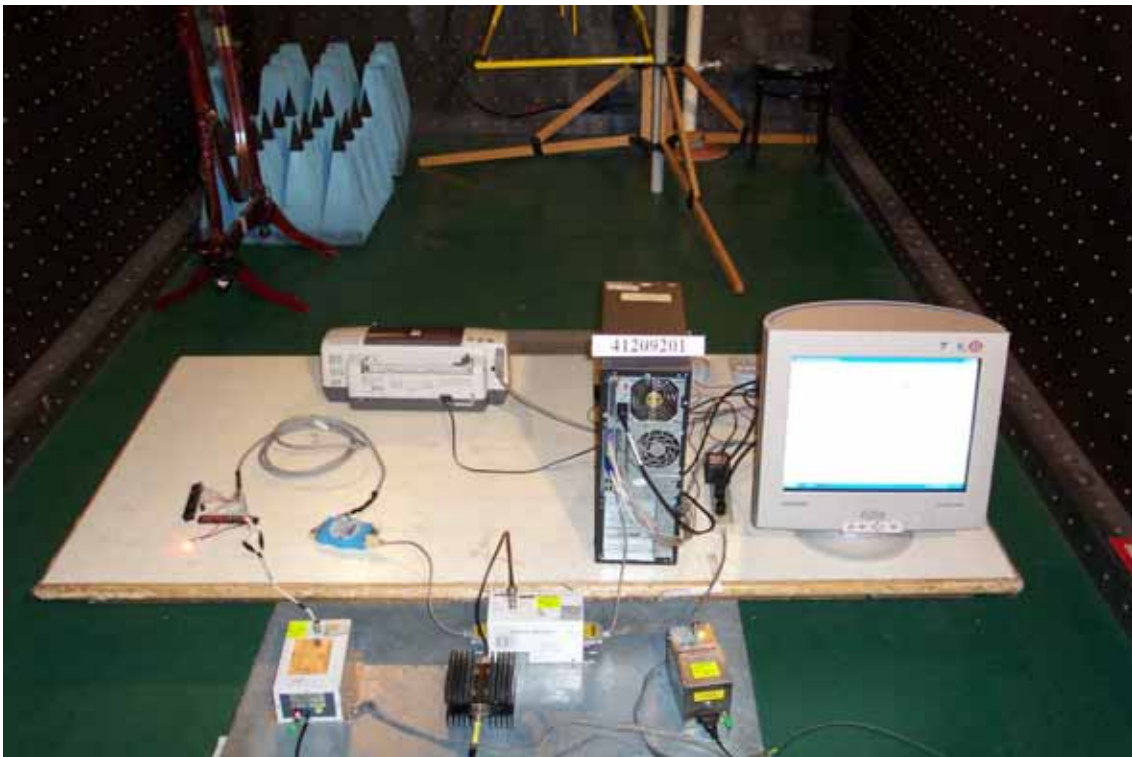
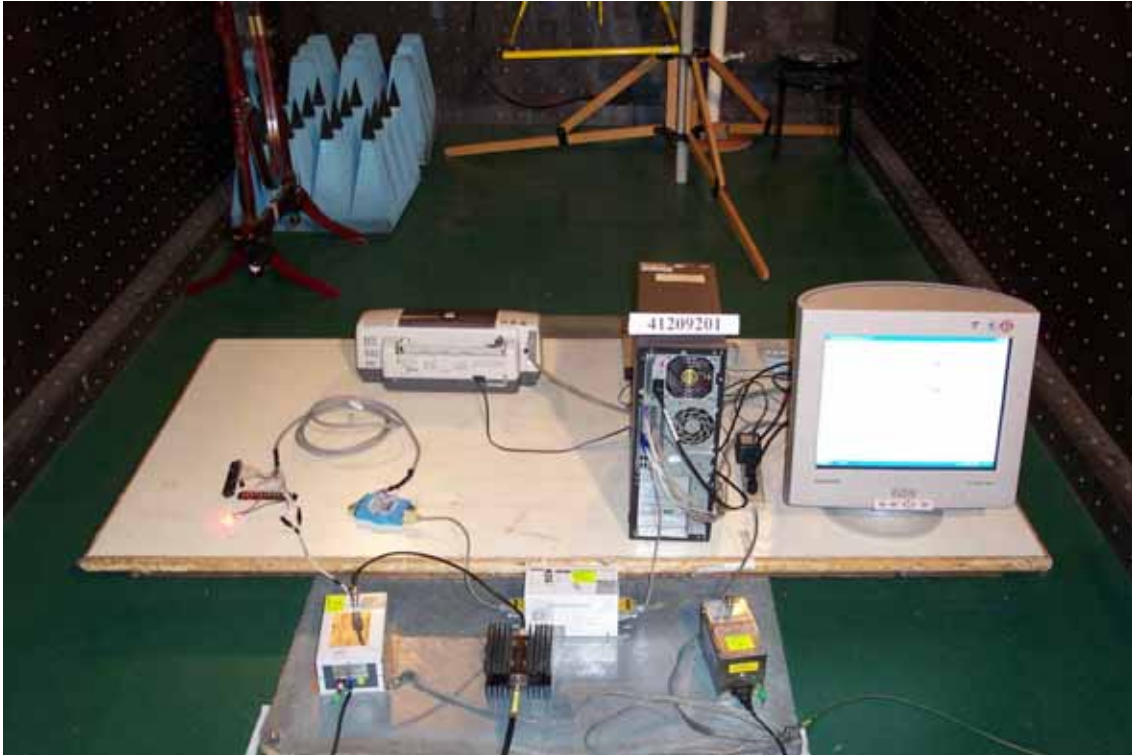

POWER FREQUENCY MAGNETIC FIELD IMMUNITY TEST

