



# CERTIFICATE

**Issued Date: Oct. 07, 2009**  
**Report No.: 099361R-ITCEP11V03**

This is to certify that the following designated product

**Product : Network Camera**  
**Trade name : VIVOTEK**  
**Model Number : IP7361**  
**Company Name : VIVOTEK INC.**

This product, which has been issued the test report listed as above in Quietek Laboratory, is based on a single evaluation of one sample and confirmed to comply with the requirements of the following EMC standard.

**EN 55022: 2006+A1: 2007**

**EN 61000-3-2:2006**

**EN 61000-3-3:1995+A1: 2001+A2: 2005**

**AS/NZS CISPR 22: 2006**

**EN 55024: 1998+A1: 2001+A2: 2003**

**IEC 61000-4-2 Edition 1.2: 2001-04**

**IEC 61000-4-3 Edition 3.0: 2006**

**IEC 61000-4-4: 2004**

**IEC 61000-4-5 Edition 2.0: 2005**

**IEC 61000-4-6 Edition 2.2: 2006**

**IEC 61000-4-8 Edition 1.1: 2001-03**

**IEC 61000-4-11 Second Edition: 2004-03**

TEST LABORATORY

Vincent Lin / Manager



# Test Report

Product Name : Network Camera

Model No. : IP7361

Applicant : VIVOTEK INC.

Address : 6F, No.192, Lien-Cheng Rd., Chung-Ho City, Taipei  
County, Taiwan, R.O.C.

Date of Receipt : 2009/09/17

Issued Date : 2009/10/07

Report No. : 099361R-ITCEP11V03

Report Version : V1.0

The test results relate only to the samples tested.

The test results shown in the test report are traceable to the national/international standard through the calibration of the equipment and evaluated measurement uncertainty herein.

This report must not be used to claim product endorsement by TAF, NVLAP or any agency of the Government.

The test report shall not be reproduced except in full without the written approval of QuieTek Corporation.



# Declaration of Conformity

We herewith confirm the following designated products to comply with the requirements set out in the Council Directive on the approximation of the laws of the Member States relating to Electromagnetic Compatibility Directive (2004/108/EC) with applicable standards listed below.

Product : Network Camera  
Trade name : VIVOTEK  
Model Number : IP7361  
Applicable Harmonized : EN 55022:2006+A1: 2007, Class A  
Standards under Directive EN 55024: 1998+A1: 2001+A2: 2003  
2004/108/EC EN 61000-3-2:2006  
EN 61000-3-3:1995+A1: 2001+A2: 2005

Company Name : \_\_\_\_\_  
Company Address : \_\_\_\_\_  
Telephone : \_\_\_\_\_ Facsimile : \_\_\_\_\_

Person in responsible for marking this declaration:

_____ Name (Full Name)	_____ Title/ Department
_____ Date	_____ Legal Signature



## Statement of Conformity

This statement is to certify that the designated product below.

Product : Network Camera  
Trade name : VIVOTEK  
Model Number : IP7361  
Company Name : VIVOTEK INC.  
Applicable Standards : EN 55022:2006+A1: 2007, Class A  
EN 55024: 1998+A1: 2001+A2: 2003  
EN 61000-3-2:2006  
EN 61000-3-3:1995+A1: 2001+A2: 2005

One sample of the designated product has been tested and evaluated in our laboratory to find in compliance with the applicable standards above. The issued test report(s) show(s) it in detail.

Report Number : 099361R-ITCEP11V03



TEST LABORATORY



Vincent Lin / Manager

The verification is based on a single evaluation of one sample of above-mentioned products. It does not imply an assessment of the whole production and does not permit the use of the test lab. Logo.

## Test Report Certification

Issued Date : 2009/10/07

Report No. : 099361R-ITCEP11V03



Product Name : Network Camera  
Applicant : VIVOTEK INC.  
Address : 6F, No.192, Lien-Cheng Rd., Chung-Ho City, Taipei County,  
Taiwan, R.O.C.  
Manufacturer : VIVOTEK INC.  
Model No. : IP7361  
EUT Rated Voltage : AC 100-240V, 50-60Hz  
EUT Test Voltage : 1. AC 230V/50Hz  
2. DC 24V (By PoE)  
Trade Name : VIVOTEK  
Applicable Standard : EN 55022: 2006+A1: 2007, Class A  
EN 55024: 1998+A1: 2001+A2: 2003  
EN 61000-3-2:2006  
EN 61000-3-3:1995+A1: 2001+A2: 2005  
AS/NZS CISPR 22: 2006  
Test Result : Complied  
Performed Location : Quietek Corporation (Linkou Laboratory)  
No.5-22, Ruei-Shu Valley, Ruei-Ping Tsuen Lin Kuo Shiang,  
Taipei, 244 Taiwan, R.O.C.  
TEL:+866-2-8601-3788 / FAX:+886-2-8601-3789

Documented By :

(Adm. Specialist / Joanne Lin)

Reviewed By :

( Engineer / Harrison Chen )

Approved By :

( Manager / Vincent Lin )

## Laboratory Information

We , **Quietek Corporation**, are an independent EMC and safety consultancy that was established the whole facility in our laboratories. The test facility has been accredited/accepted (audited or listed) by the following related bodies in compliance with ISO 17025, EN 45001 and specified testing scopes:

<b>Taiwan R.O.C.</b>	<b>:</b>	<b>BSMI, NCC, TAF</b>
<b>Germany</b>	<b>:</b>	<b>TUV Rheinland</b>
<b>Norway</b>	<b>:</b>	<b>Nemko, DNV</b>
<b>USA</b>	<b>:</b>	<b>FCC, NVLAP</b>
<b>Japan</b>	<b>:</b>	<b>VCCI</b>

The related certificate for our laboratories about the test site and management system can be downloaded from Quietek Corporation's Web Site : <http://tw.quietek.com/modules/enterprise/services.php?item=100>  
The address and introduction of Quietek Corporation's laboratories can be founded in our Web site : <http://www.quietek.com/>

If you have any comments, Please don't hesitate to contact us. Our contact information is as below:

### HsinChu Testing Laboratory :

No.75-2, 3rd Lin, Wangye Keng, Yonghxing Tsuen, Qionglin Shiang, Hsinchu County 307, Taiwan, R.O.C.

TEL:+886-3-592-8858 / FAX:+886-3-592-8859

E-Mail : [service@quietek.com](mailto:service@quietek.com)



### LinKou Testing Laboratory :

No. 5-22, Ruei-Shu Valley, Ruei-Ping Tsuen, Lin-Kou Shiang, Taipei, Taiwan, R.O.C.

TEL : 886-2-8601-3788 / FAX : 886-2-8601-3789

E-Mail : [service@quietek.com](mailto:service@quietek.com)



### Suzhou (China) Testing Laboratory :

No. 99 Hongye Rd., Suzhou Industrial Park Loufeng Hi-Tech Development Zone., Suzhou, China.

TEL : +86-512-6251-5088 / FAX : +86-512-6251-5098

E-Mail : [service@quietek.com](mailto:service@quietek.com)



**TABLE OF CONTENTS**

Description	Page
1. General Information .....	7
1.1. EUT Description.....	7
1.2. Mode of Operation .....	7
1.3. Tested System Details .....	9
1.4. Configuration of Tested System .....	10
1.5. EUT Exercise Software.....	12
2. Technical Test .....	13
2.1. Summary of Test Result.....	13
2.2. List of Test Equipment .....	14
2.3. Measurement Uncertainty.....	17
2.4. Test Environment.....	19
3. Conducted Emission (Main Terminals).....	20
3.1. Test Specification .....	20
3.2. Test Setup.....	20
3.3. Limit .....	20
3.4. Test Procedure .....	21
3.5. Deviation from Test Standard.....	21
3.6. Test Result .....	22
3.7. Test Photograph .....	28
4. Conducted Emissions (Telecommunication Ports).....	29
4.1. Test Specification .....	29
4.2. Test Setup.....	29
4.3. Limit .....	29
4.4. Test Procedure .....	30
4.5. Deviation from Test Standard.....	30
4.6. Test Result .....	31
4.7. Test Photograph .....	43
5. Radiated Emission .....	45
5.1. Test Specification .....	45
5.2. Test Setup.....	45
5.3. Limit .....	45
5.4. Test Procedure .....	46
5.5. Deviation from Test Standard.....	46
5.6. Test Result.....	47
5.7. Test Photograph .....	50
6. Harmonic Current Emission .....	53

6.1.	Test Specification .....	53
6.2.	Test Setup.....	53
6.3.	Limit.....	53
6.4.	Test Procedure .....	55
6.5.	Deviation from Test Standard.....	55
6.6.	Test Result.....	56
6.7.	Test Photograph .....	58
7.	Voltage Fluctuation and Flicker.....	59
7.1.	Test Specification.....	59
7.2.	Test Setup.....	59
7.3.	Limit.....	59
7.4.	Test Procedure .....	60
7.5.	Deviation from Test Standard.....	60
7.6.	Test Result.....	61
7.7.	Test Photograph .....	62
8.	Electrostatic Discharge .....	63
8.1.	Test Specification.....	63
8.2.	Test Setup.....	63
8.3.	Limit.....	63
8.4.	Test Procedure .....	64
8.5.	Deviation from Test Standard.....	64
8.6.	Test Result.....	65
8.7.	Test Photograph .....	66
9.	Radiated Susceptibility .....	68
9.1.	Test Specification.....	68
9.2.	Test Setup.....	68
9.3.	Limit.....	68
9.4.	Test Procedure .....	69
9.5.	Deviation from Test Standard.....	69
9.6.	Test Result.....	70
9.7.	Test Photograph .....	72
10.	Electrical Fast Transient/Burst.....	73
10.1.	Test Specification.....	73
10.2.	Test Setup.....	73
10.3.	Limit.....	73
10.4.	Test Procedure .....	74
10.5.	Deviation from Test Standard.....	74
10.6.	Test Result.....	75



10.7.	Test Photograph .....	77
11.	Surge .....	78
11.1.	Test Specification .....	78
11.2.	Test Setup.....	78
11.3.	Limit.....	78
11.4.	Test Procedure .....	79
11.5.	Deviation from Test Standard.....	79
11.6.	Test Result.....	80
11.7.	Test Photograph .....	80
12.	Conducted Susceptibility .....	82
12.1.	Test Specification .....	82
12.2.	Test Setup.....	82
12.3.	Limit.....	83
12.4.	Test Procedure .....	83
12.5.	Deviation from Test Standard.....	83
12.6.	Test Result.....	84
12.7.	Test Photograph .....	86
13.	Power Frequency Magnetic Field .....	88
13.1.	Test Specification .....	88
13.2.	Test Setup.....	88
13.3.	Limit.....	88
13.4.	Test Procedure .....	88
13.5.	Deviation from Test Standard.....	88
13.6.	Test Result.....	89
13.7.	Test Photograph .....	91
14.	Voltage Dips and Interruption.....	92
14.1.	Test Specification .....	92
14.2.	Test Setup.....	92
14.3.	Limit.....	92
14.4.	Test Procedure .....	93
14.5.	Deviation from Test Standard.....	93
14.6.	Test Result.....	94
14.7.	Test Photograph .....	94
15.	Attachment .....	96
	EUT Photograph.....	96

**1. General Information****1.1. EUT Description**

Product Name	Network Camera
Trade Name	VIVOTEK
Model No.	IP7361

Component	
Power Adapter	MFR: ENG, M/N: 3A-183WP12 Input: AC 100-240, 50-60Hz, 0.6A Output: DC 12V, 1.5A Cable Out: Non-shielded, 1.6m

**1.2. Mode of Operation**

QuieTek has verified the construction and function in typical operation. All the test modes were carried out with the EUT in normal operation, which was shown in this test report and defined as:

Pre-Test Mode	
Mode 1: Normal Operation (Adapter)	
Mode 2: Normal Operation (PoE)	
Final Test Mode	
Conducted Emission	Mode 1: Normal Operation (Adapter)
Radiated Emission	Mode 1: Normal Operation (Adapter)
	Mode 2: Normal Operation (PoE)
Immunity	Mode 1: Normal Operation (Adapter)
	Mode 2: Normal Operation (PoE)

### 1.3. Tested System Details

The types for all equipments, plus descriptions of all cables used in the tested system (including inserted cards) are:

Test Mode		Mode 1			
Product		Manufacturer	Model No.	Serial No.	Power Cord
1	Notebook PC	DELL	PP04X	2D2ZM1S	Non-Shielded, 0.8m

Test Mode		Mode 2			
Product		Manufacturer	Model No.	Serial No.	Power Cord
1	Notebook PC	DELL	PP04X	2D2ZM1S	Non-Shielded, 0.8m
2	PoE	LINKSYS	WAPP0E12	N/A	Non-Shielded, 1.8m With Core*1

1.4. Configuration of Tested System

Test Mode		Mode 1
Connection Diagram		
Signal Cable Type		Signal cable Description
A	LAN Cable	Non-Shielded, 3m

Test Mode		Mode 2	
Connection Diagram			
<pre> graph TD     EUT[EUT] --- B[B] --- PoE[PoE (2)]     PoE --- A[A] --- PC[Notebook PC (1)]     subgraph DashedBox [ ]         EUT         PoE     end         </pre>			
Signal Cable Type		Signal cable Description	
A	LAN Cable	Non-Shielded, 0.3m	
A	LAN Cable	Non-Shielded, 3m	

**1.5. EUT Exercise Software**

1	Setup the EUT and simulators as shown on 1.4.
2	Turn on the power of all equipment.
3	The EUT will start to operate and display the video figure from the signal source.
4	The EUT will display “video figure” on monitor.
5	Repeat the above procedure (3) to (4).

## 2. Technical Test

### 2.1. Summary of Test Result

- No deviations from the test standards  
 Deviations from the test standards as below description:

Emission			
Performed Item	Normative References	Test Performed	Deviation
Conducted Emission	EN 55022: 2006+A1: 2007, Class A AS/NZS CISPR 22: 2006	Yes	No
Impedance Stabilization Network	EN 55022: 2006+A1: 2007, Class A AS/NZS CISPR 22: 2006	Yes	No
Radiated Emission	EN 55022: 2006+A1: 2007, Class A AS/NZS CISPR 22: 2006	Yes	No
Power Harmonics	EN 61000-3-2:2006	Yes	No
Voltage Fluctuation and Flicker	EN 61000-3-3:1995+A1: 2001+A2: 2005	Yes	No

Immunity			
Performed Item	Normative References	Test Performed	Deviation
Electrostatic Discharge	IEC 61000-4-2 Edition 1.2: 2001-04	Yes	No
Radiated susceptibility	IEC 61000-4-3 Edition 3.0: 2006	Yes	No
Electrical fast transient/burst	IEC 61000-4-4:2004	Yes	No
Surge	IEC 61000-4-5 Edition 2.0: 2005	Yes	No
Conducted susceptibility	IEC 61000-4-6 Edition 2.2: 2006	Yes	No
Power frequency magnetic field	IEC 61000-4-8 Edition 1.1: 2001-03	Yes	No
Voltage dips and interruption	IEC 61000-4-11 2nd Edition: 2004-03	Yes	No



## 2.2. List of Test Equipment

### Conducted Emission / SR1

Instrument	Manufacturer	Type No.	Serial No	Cal. Date
EMI Test Receiver	R&S	ESCS 30	100366	2008/10/20
LISN	R&S	ENV4200	833209/007	2009/08/14
LISN	R&S	ENV216	100085	2009/02/17
Pulse Limiter	R&S	ESH3-Z2	357.88.10.52	2009/09/09

### Impedance Stabilization Network / SR1

Instrument	Manufacturer	Type No.	Serial No	Cal. Date
Capacitive Voltage Probe	Schaffner	CVP2200A	18331	2008/11/14
EMI Test Receiver	R&S	ESCS 30	100366	2008/10/20
LISN	R&S	ENV216	100085	2009/02/17
LISN	R&S	ENV4200	833209/007	2009/08/14
Impedance Stabilization Network	Schaffner	ISN T400	19099	2009/09/19
Pulse Limiter	R&S	ESH3-Z2	357.88.10.52	2009/09/09
RF Current Probe	FCC	F-65 10KHz~1GHz	198	2008/11/14
BALANCED TELECOM ISN	FCC	FCC-TLISN-T2-02	20316	2008/11/18
BALANCED TELECOM ISN	FCC	FCC-TLISN-T4-02	20317	2008/11/18
BALANCED TELECOM ISN	FCC	FCC-TLISN-T8-02	20319	2008/11/18

### Radiated Emission / Site3

Instrument	Manufacturer	Type No.	Serial No	Cal. Date
Bilog Antenna	Schaffner Chase	CBL6112B	2704	2009/08/04
Broadband Horn Antenna	Schwarzbeck	BBHA9170	208	2009/07/30
EMI Test Receiver	R&S	ESCS 30	838251/001	2009/04/15
Horn Antenna	Schwarzbeck	BBHA9120D	305	2009/08/13
Pre-Amplifier	QTK	N/A	N/A	2009/01/03
Spectrum Analyzer	Advantest	R3162	100803470	2008/11/25
EMI Test Receiver	R&S	ESI 26	838786/004	2009/07/22
Pre-Amplifier	MITEQ	QMF-4D-18040 0-45-6P	925974	2009/01/03

### Radiated Emission / 9x6x6 Chamber

Instrument	Manufacturer	Type No.	Serial No	Cal. Date
Spectrum Analyzer (9K-26.5GHz)	Agilent	E4408B	MY45102743	2009/08/12
Horn Antenna	Schwarzbeck	9120D	576	2008/10/21
Pre-Amplifier	Quietek	AP-180C	CHM/071920	2009/08/04

### Power Harmonics / SR3

Instrument	Manufacturer	Type No.	Serial No	Cal. Date
AC Power Source(Harmonic)	Schaffner	NSG 1007	HK54148	2009/06/23
IEC1000-4-X Analyzer(Flicker)	Schaffner	CCN 1000-1	X7 1887	2009/06/23

### Voltage Fluctuation and Flicker / SR3

Instrument	Manufacturer	Type No.	Serial No	Cal. Date
AC Power Source(Harmonic)	Schaffner	NSG 1007	HK54148	2009/06/23
IEC1000-4-X Analyzer(Flicker)	Schaffner	CCN 1000-1	X7 1887	2009/06/23

### Electrostatic Discharge / SR3

Instrument	Manufacturer	Type No.	Serial No	Cal. Date
ESD simulator system	TESEQ	NSG 438	695	2009/01/15
Horizontal Coupling Plane(HCP)	Quietek	HCP AL50	N/A	N/A
Vertical Coupling Plane(VCP)	Quietek	VCP AL50	N/A	N/A

### Radiated susceptibility / CB5

Instrument	Manufacturer	Type No.	Serial No	Cal. Date
AF-BOX	R&S	AF-BOX ACCUST	100007	N/A
Audio Analyzer	R&S	UPL 16	100137	2009/04/23
Bilog Antenna	Schaffner Chase	CBL6112B	2450	2009/01/03
Broad-Band Antenna	Schwarzbeck	VULB 9166	1085	2009/08/02
Biconilog Antenna	EMCO	3149	00071675	2009/05/29
Directional Coupler	A&R	DC 6180	22735	N/A
Dual Microphone Supply	B&K	5935	2426784	2009/08/14
Mouth Simulator	B&K	4227	2439692	2009/08/14
Power Amplifier	A&R	30S1G3	309453	N/A
Power Amplifier	A&R	100W10000M7	A285000010	N/A
Power Amplifier	SCHAFFNER	CBA9413B	4020	N/A
Power Amplifier	AR	75A250A	0325371	N/A
Power Meter	R&S	NRVD(P.M)	100219	2009/04/05
Pre-Amplifier	A&R	150A220	23067	N/A
Probe Microphone	B&K	4182	2278070	2009/08/14
Signal Generator	R&S	SMY02(9K-2080)	825454/028	2008/11/21

### Electrical fast transient/burst / SR6

Instrument	Manufacturer	Type No.	Serial No	Cal. Date
EMC immunity system	Thermo	EMCPRO PLUS	411225	2008/12/01

### Surge / SR6

Instrument	Manufacturer	Type No.	Serial No	Cal. Date
EMC immunity system	Thermo	EMCPRO PLUS	0411225	2008/12/01

### Conducted susceptibility / SR6

Instrument	Manufacturer	Type No.	Serial No	Cal. Date
Schaffner NSG 2070 RF-Generator	Schaffner	N/A	N/A	2009/04/21

### Power frequency magnetic field / SR3

Instrument	Manufacturer	Type No.	Serial No	Cal. Date
Induction Coil Interface	Schaffner	INA 2141	6002	N/A
Magnetic Loop Coil	Schaffner	INA 702	160	N/A
Triaxial ELF Magnetic Field Meter	F.B.BELL	4090	114135	2009/03/27

Voltage dips and interruption / SR6

Instrument	Manufacturer	Type No.	Serial No	Cal. Date
EMC immunity system	Thermo	EMCPRO PLUS	0411225	2008/12/01

Schaffner NSG 2070 RF-Generator				
Instrument	Manufacturer	Type No.	Serial No	Cal. Date
CDN	Schaffner	CAL U100A	20405	N/A
CDN	Schaffner	TRA U150	20454	N/A
CDN M016S	Schaffner	CAL U100A	20410	N/A
CDN M016S	Schaffner	TRA U150	21167	N/A
CDN T002	Schaffner	CAL U100	20491	N/A
CDN T002	Schaffner	TRA U150	21169	N/A
CDN T400	Schaffner	CAL U100	17735	N/A
CDN T400	Schaffner	TRA U150	21166	N/A
Coupling Decoupling Network	Schaffner	CDN M016S	20823	2009/04/02
Coupling Decoupling Network	Schaffner	CDN T002	19018	2009/04/02
Coupling Decoupling Network	Schaffner	CDN T400	21226	2009/04/02
EM-CLAMP	Schaffner	KEMZ 801	21024	2009/04/02

### **2.3. Measurement Uncertainty**

Conducted Emission

The measurement uncertainty is evaluated as  $\pm 2.26$  dB.

Impedance Stabilization Network

The measurement uncertainty is evaluated as  $\pm 2.26$  dB.

Radiated Emission

The measurement uncertainty is evaluated as  $\pm 3.19$  dB.

Electrostatic Discharge

As what is concluded in the document from Note2 of clause 5.4.6.2 of ISO/IEC 17025: 1999[2], the requirements for measurement uncertainty in ESD testing are deemed to have been satisfied, and the testing is reported in accordance with the relevant ESD standards. The immunity test signal from the ESD system meet the required specifications in IEC 61000-4-2 through the calibration report with the calibrated uncertainty for the waveform of voltage and timing as being 1.63 % and 2.76%.

Radiated susceptibility

As what is concluded in the document from Note2 of clause 5.4.6.2 of ISO/IEC 17025: 1999[2], the requirements for measurement uncertainty in RS testing are deemed to have been satisfied, and the testing is reported in accordance with the relevant RS standards. The immunity test signal from the RS system meet the required specifications in IEC 61000-4-3 through the calibration for the uniform field strength and monitoring for the test level with the uncertainty evaluation report for the electrical filed strength as being 2.72 dB.

Electrical fast transient/burst

As what is concluded in the document from Note2 of clause 5.4.6.2 of ISO/IEC 17025: 1999[2], the requirements for measurement uncertainty in EFT/Burst testing are deemed to have been satisfied, and the testing is reported in accordance with the relevant EFT/Burst standards. The immunity test signal from the EFT/Burst system meet the required specifications in IEC 61000-4-4 through the calibration report with the calibrated uncertainty for the waveform of voltage, frequency and timing as being 1.63 %,and 2.76%.

Surge

As what is concluded in the document from Note2 of clause 5.4.6.2 of ISO/IEC 17025: 1999[2], the requirements for measurement uncertainty in Surge testing are deemed to have been satisfied, and the testing is reported in accordance with the relevant Surge standards. The immunity test signal from the Surge system meet the required specifications in IEC 61000-4-5 through the calibration report with the calibrated uncertainty for the waveform of voltage and timing as being 1.63 % and 2.76%.

#### Conducted susceptibility

As what is concluded in the document from Note2 of clause 5.4.6.2 of ISO/IEC 17025: 1999[2], the requirements for measurement uncertainty in CS testing are deemed to have been satisfied, and the testing is reported in accordance with the relevant CS standards. The immunity test signal from the CS system meet the required specifications in IEC 61000-4-6 through the calibration for unmodulated signal and monitoring for the test level with the uncertainty evaluation report for the injected modulated signal level through CDN and EM Clamp/Direct Injection as being 3.72 dB and 2.78 dB.

#### Power frequency magnetic field

As what is concluded in the document from Note2 of clause 5.4.6.2 of ISO/IEC 17025: 1999[2], the requirements for measurement uncertainty in PFM testing are deemed to have been satisfied, and the testing is reported in accordance with the relevant PFM standards. The immunity test signal from the PFM system meet the required specifications in IEC 61000-4-8 through the calibration report with the calibrated uncertainty for the Gauss Meter to verify the output level of magnetic field strength as being 2 %.

#### Voltage dips and interruption

As what is concluded in the document from Note2 of clause 5.4.6.2 of ISO/IEC 17025: 1999[2], the requirements for measurement uncertainty in DIP testing are deemed to have been satisfied, and the testing is reported in accordance with the relevant DIP standards. The immunity test signal from the DIP system meet the required specifications in IEC 61000-4-11 through the calibration report with the calibrated uncertainty for the waveform of voltage and timing as being 1.63 % and 2.76%.

## 2.4. Test Environment

Performed Item	Items	Required	Actual
Conducted Emission	Temperature (°C)	15-35	25
	Humidity (%RH)	25-75	50
	Barometric pressure (mbar)	860-1060	950-1000
Impedance Stabilization Network	Temperature (°C)	15-35	25
	Humidity (%RH)	25-75	50
	Barometric pressure (mbar)	860-1060	950-1000
Radiated Emission	Temperature (°C)	15-35	25
	Humidity (%RH)	25-75	50
	Barometric pressure (mbar)	860-1060	950-1000
Electrostatic Discharge	Temperature (°C)	15-35	25
	Humidity (%RH)	30-60	54
	Barometric pressure (mbar)	860-1060	950-1000
Radiated susceptibility	Temperature (°C)	15-35	21
	Humidity (%RH)	25-75	51
	Barometric pressure (mbar)	860-1060	950-1000
Electrical fast transient/burst	Temperature (°C)	15-35	23
	Humidity (%RH)	25-75	53
	Barometric pressure (mbar)	860-1060	950-1000
Surge	Temperature (°C)	15-35	23
	Humidity (%RH)	10-75	53
	Barometric pressure (mbar)	860-1060	950-1000
Conducted susceptibility	Temperature (°C)	15-35	25
	Humidity (%RH)	25-75	51
	Barometric pressure (mbar)	860-1060	950-1000
Power frequency magnetic field	Temperature (°C)	15-35	22
	Humidity (%RH)	25-75	51
	Barometric pressure (mbar)	860-1060	950-1000
Voltage dips and interruption	Temperature (°C)	15-35	23
	Humidity (%RH)	25-75	53
	Barometric pressure (mbar)	860-1060	950-1000

### 3. Conducted Emission (Main Terminals)

#### 3.1. Test Specification

According to EMC Standard : EN 55022 and AS/NZS CISPR 22

#### 3.2. Test Setup

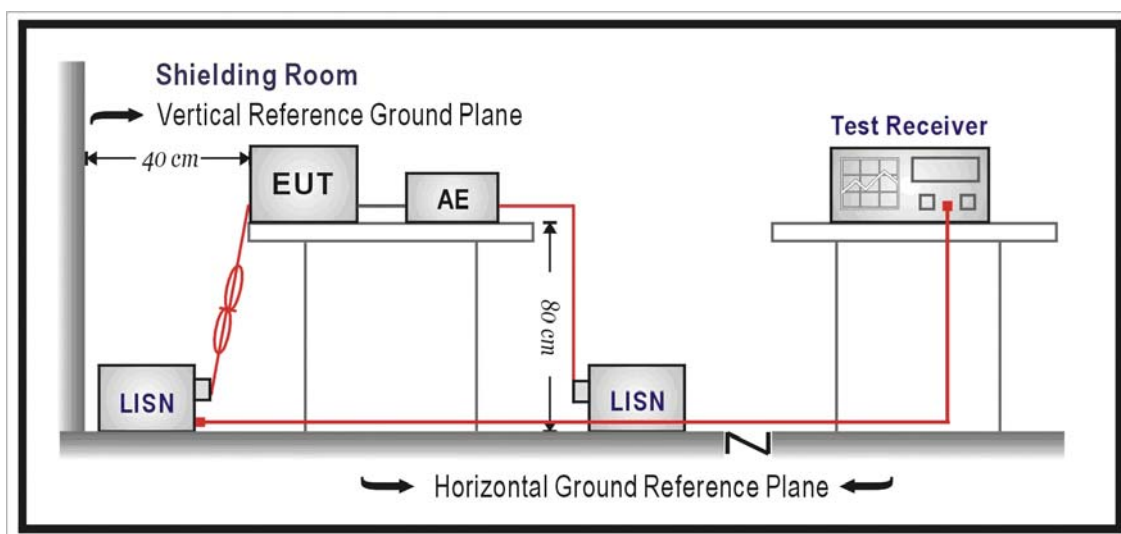

#### 3.3. Limit

Limits		
Frequency (MHz)	QP (dBuV)	AV (dBuV)
0.15 - 0.50	79	66
0.50-5.0	73	60
5.0 - 30	73	60

Remarks: In the above table, the tighter limit applies at the band edges.

### **3.4. Test Procedure**

The EUT and simulators are connected to the main power through a line impedance stabilization network (L.I.S.N.). This provides a 50 ohm /50uH coupling impedance for the measuring equipment. The peripheral devices are also connected to the main power through a LISN that provides a 50ohm/50uH coupling impedance with 50ohm termination.

(Please refers to the block diagram of the test setup and photographs.)

Both sides of A.C. line are checked for maximum conducted interference. In order to find the maximum emission, the relative positions of equipment and all of the interface cables must be changed on conducted measurement.

Conducted emissions were invested over the frequency range from 0.15MHz to 30MHz using a receiver bandwidth of 9kHz.

### **3.5. Deviation from Test Standard**

No deviation.



**3.6. Test Result**

<b>Site : SR1</b>	<b>Time : 2009/09/25 - 14:33</b>
<b>Limit : CISPR_A_00M_QP</b>	<b>Margin : 10</b>
<b>EUT : Network Camera</b>	<b>Probe : ENV_216_L1 - Line1</b>
<b>Power : AC 230V/50Hz</b>	<b>Note : Mode 1</b>

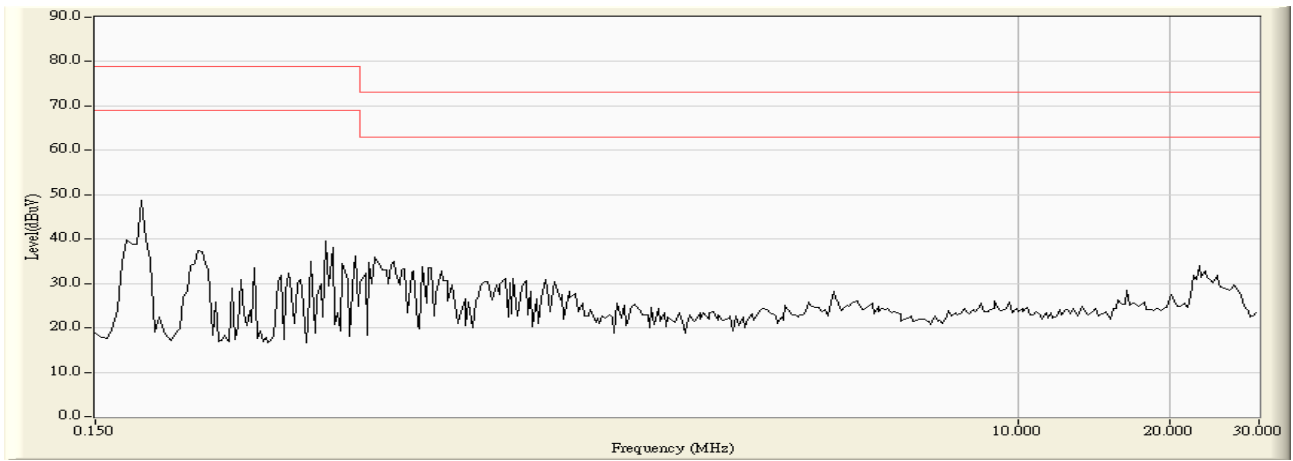

Site : SR1	Time : 2009/09/25 - 14:33
Limit : CISPR_A_00M_QP	Margin : 0
EUT : Network Camera	Probe : ENV_216_L1 - Line1
Power : AC 230V/50Hz	Note : Mode 1

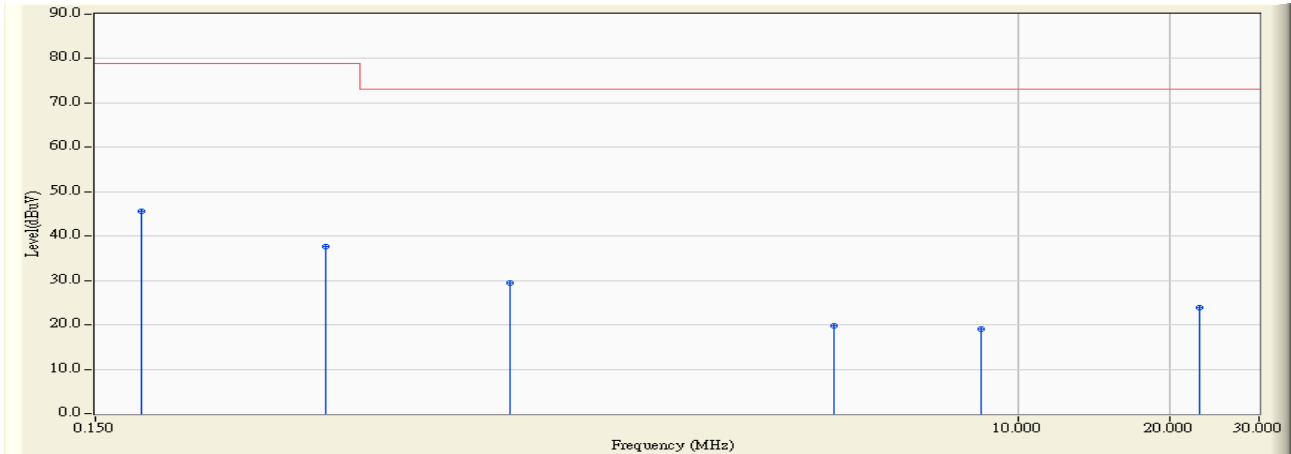

		Frequency (MHz)	Correct Factor (dB)	Reading Level (dBuV)	Measure Level (dBuV)	Margin (dB)	Limit (dBuV)	Detector Type
1	*	0.185	9.790	35.720	45.510	-33.490	79.000	QUASIPeAK
2		0.427	9.790	27.960	37.750	-41.250	79.000	QUASIPeAK
3		0.994	9.800	19.580	29.380	-43.620	73.000	QUASIPeAK
4		4.330	9.820	10.070	19.890	-53.110	73.000	QUASIPeAK
5		8.447	9.860	9.240	19.100	-53.900	73.000	QUASIPeAK
6		22.849	10.130	13.850	23.980	-49.020	73.000	QUASIPeAK

**Note:**

1. All Reading Levels are Quasi-Peak and average value.
2. " \* ", means this data is the worst emission level.
3. Measurement Level = Reading Level + Correct Factor

Site : SR1	Time : 2009/09/25 - 14:33
Limit : CISPR_A_00M_AV	Margin : 0
EUT : Network Camera	Probe : ENV_216_L1 - Line1
Power : AC 230V/50Hz	Note : Mode 1

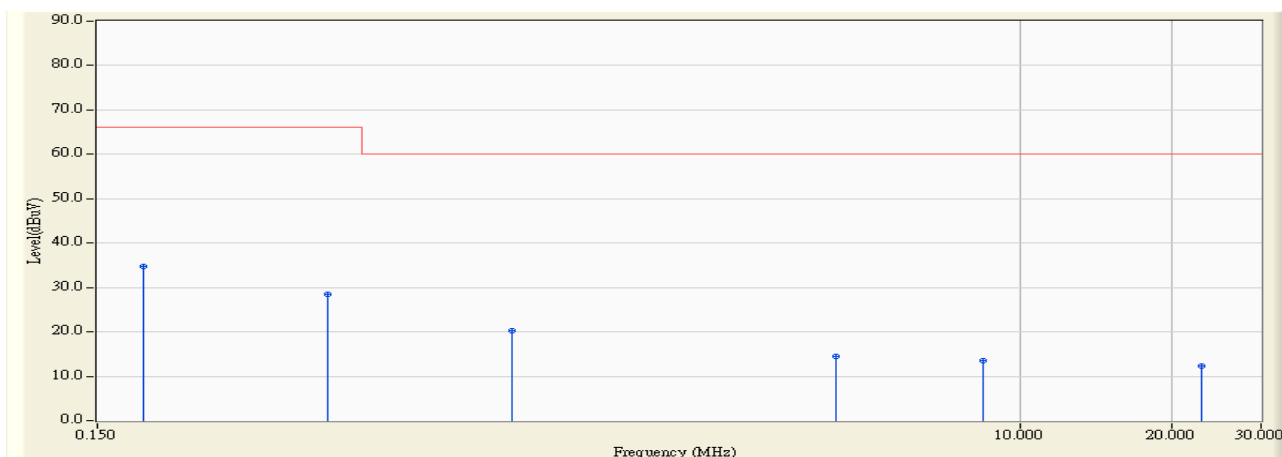

		Frequency (MHz)	Correct Factor (dB)	Reading Level (dBuV)	Measure Level (dBuV)	Margin (dB)	Limit (dBuV)	Detector Type
1	*	0.185	9.790	24.910	34.700	-31.300	66.000	AVERAGE
2		0.427	9.790	18.570	28.360	-37.640	66.000	AVERAGE
3		0.994	9.800	10.520	20.320	-39.680	60.000	AVERAGE
4		4.330	9.820	4.640	14.460	-45.540	60.000	AVERAGE
5		8.447	9.860	3.730	13.590	-46.410	60.000	AVERAGE
6		22.849	10.130	2.170	12.300	-47.700	60.000	AVERAGE

**Note:**

1. All Reading Levels are Quasi-Peak and average value.
2. " \* ", means this data is the worst emission level.
3. Measurement Level = Reading Level + Correct Factor

Site : SR1	Time : 2009/09/25 - 14:33
Limit : CISPR_A_00M_QP	Margin : 10
EUT : Network Camera	Probe : ENV_216_N - Line2
Power : AC 230V/50Hz	Note : Mode 1

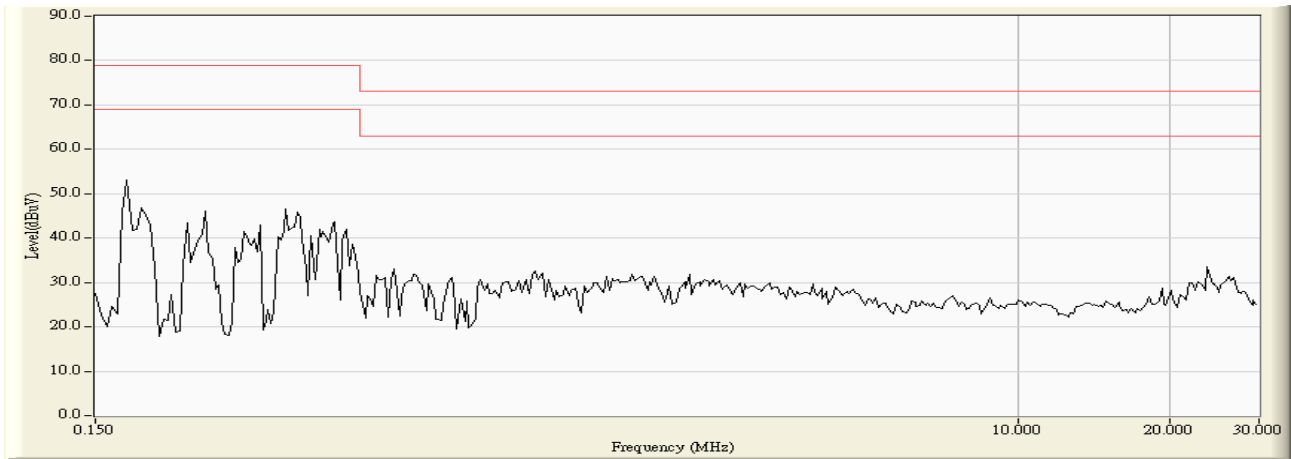

Site : SR1	Time : 2009/09/25 - 14:33
Limit : CISPR_A_00M_QP	Margin : 0
EUT : Network Camera	Probe : ENV_216_N - Line2
Power : AC 230V/50Hz	Note : Mode 1

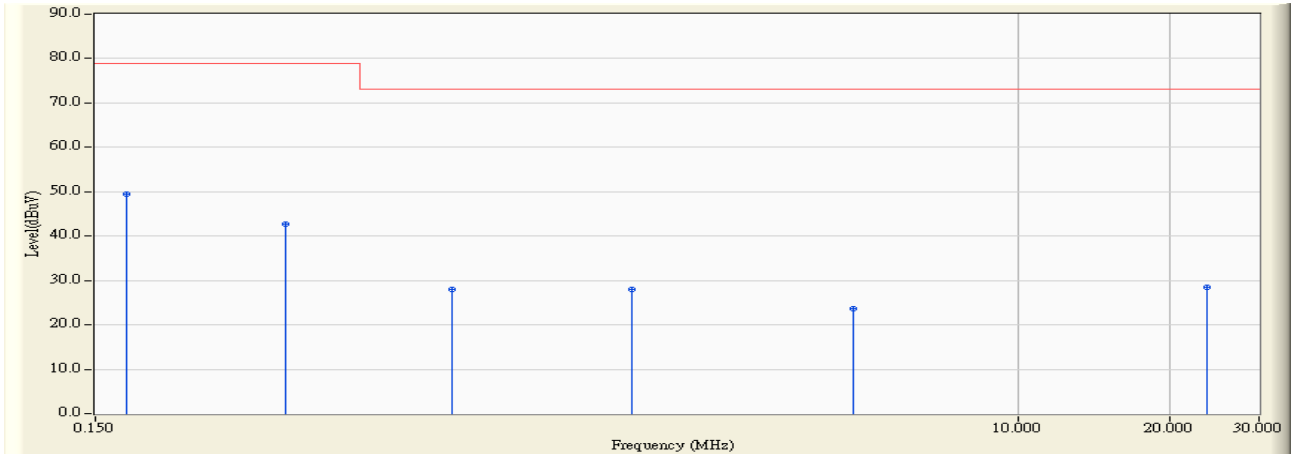

		Frequency (MHz)	Correct Factor (dB)	Reading Level (dBuV)	Measure Level (dBuV)	Margin (dB)	Limit (dBuV)	Detector Type
1	*	0.173	9.780	39.700	49.480	-29.520	79.000	QUASIPeAK
2		0.357	9.790	32.870	42.660	-36.340	79.000	QUASIPeAK
3		0.759	9.790	18.110	27.900	-45.100	73.000	QUASIPeAK
4		1.728	9.800	18.110	27.910	-45.090	73.000	QUASIPeAK
5		4.736	9.830	13.700	23.530	-49.470	73.000	QUASIPeAK
6		23.740	10.273	18.250	28.523	-44.477	73.000	QUASIPeAK

**Note:**

1. All Reading Levels are Quasi-Peak and average value.
2. " \* ", means this data is the worst emission level.
3. Measurement Level = Reading Level + Correct Factor

Site : SR1	Time : 2009/09/25 - 14:34
Limit : CISPR_A_00M_AV	Margin : 0
EUT : Network Camera	Probe : ENV_216_N - Line2
Power : AC 230V/50Hz	Note : Mode 1

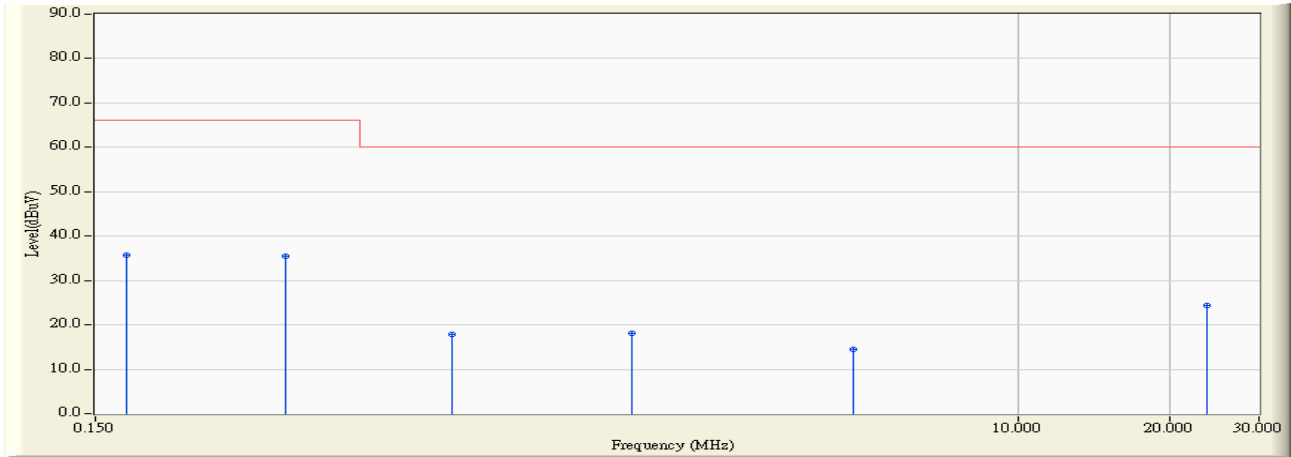

		Frequency (MHz)	Correct Factor (dB)	Reading Level (dBuV)	Measure Level (dBuV)	Margin (dB)	Limit (dBuV)	Detector Type
1	*	0.173	9.780	25.960	35.740	-30.260	66.000	AVERAGE
2	*	0.357	9.790	25.670	35.460	-30.540	66.000	AVERAGE
3		0.759	9.790	8.060	17.850	-42.150	60.000	AVERAGE
4		1.728	9.800	8.230	18.030	-41.970	60.000	AVERAGE
5		4.736	9.830	4.650	14.480	-45.520	60.000	AVERAGE
6		23.740	10.273	14.000	24.273	-35.727	60.000	AVERAGE

**Note:**

1. All Reading Levels are Quasi-Peak and average value.
2. " \* ", means this data is the worst emission level.
3. Measurement Level = Reading Level + Correct Factor

### 3.7. Test Photograph

Test Mode : Mode 1: Normal Operation (Adapter)

Description : Front View of Conducted Test



Test Mode : Mode 1: Normal Operation (Adapter)

Description : Back View of Conducted Test



#### 4. Conducted Emissions (Telecommunication Ports)

##### 4.1. Test Specification

According to EMC Standard : EN 55022 and AS/NZS CISPR 22

##### 4.2. Test Setup

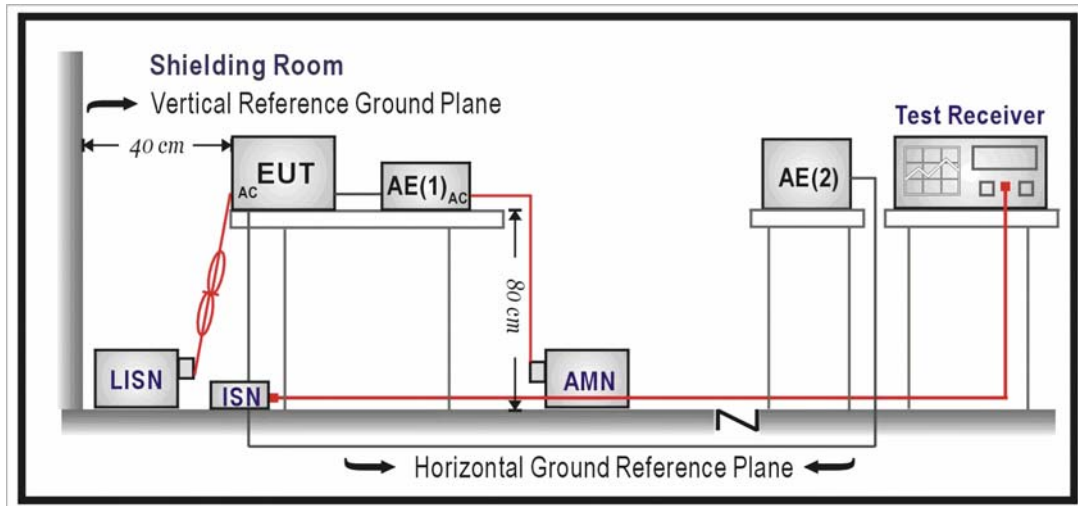

##### 4.3. Limit

Frequency (MHz)	Voltage Limits		Current Limits	
	QP (dBuV)	AV (dBuV)	QP (dBuV)	AV (dBuV)
0.15 - 0.50	97 – 87	84 – 74	53 – 43	40 – 30
0.50 - 30	87	74	43	30

Remarks:

The limit decreases linearly with the logarithm of the frequency in the range 0.15 MHz~0.50 MHz.



#### **4.4. Test Procedure**

##### **Telecommunication Port:**

The mains voltage shall be supplied to the EUT via the LISN when the measurement of telecommunication port is performed. The common mode disturbances at the telecommunication port shall be connected to the ISN, which is 150 ohm impedance.

Both alternative cables are tested related to the LCL requested. The measurement range is from 150kHz to 30MHz. The bandwidth of measurement is set to 9kHz.

The 75dB LCL ISN is used for cat. 6 cable, the 65dB LCL ISN is used for cat. 5 cable, 55dB LCL ISN is used for cat. 3.

#### **4.5. Deviation from Test Standard**

No deviation.

**4.6. Test Result**

<b>Site : SR1</b>	<b>Time : 2009/09/25 - 14:35</b>
<b>Limit : ISN_Voltage_A_00M_QP</b>	<b>Margin : 10</b>
<b>EUT : Network Camera</b>	<b>Probe : ISN_T4 - Line1</b>
<b>Power : AC 230V/50Hz</b>	<b>Note : Mode 1, ISN 10Mbps</b>

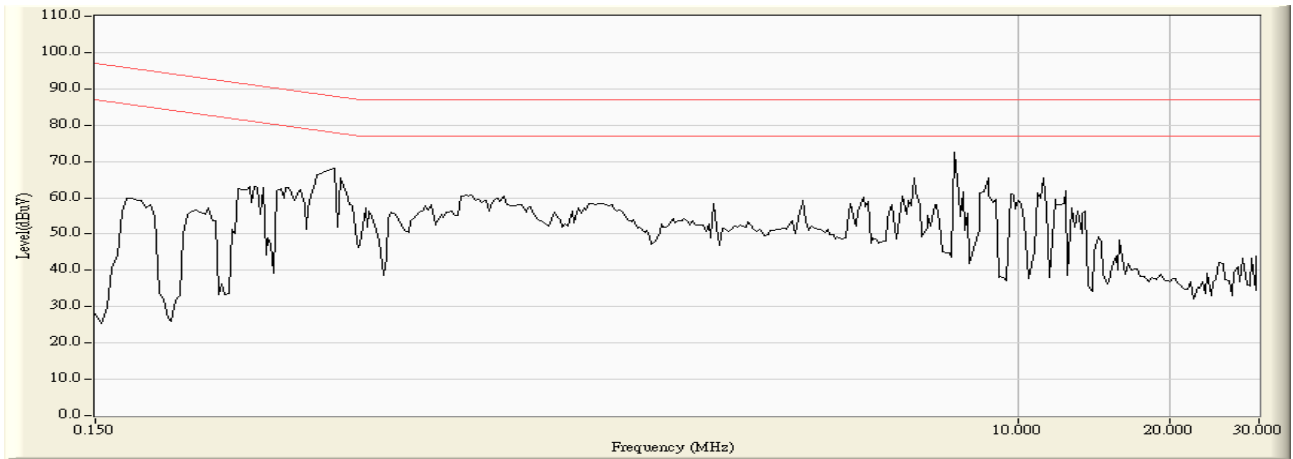

Site : SR1	Time : 2009/09/25 - 14:35
Limit : ISN_Voltage_A_00M_QP	Margin : 0
EUT : Network Camera	Probe : ISN_T4 - Line1
Power : AC 230V/50Hz	Note : Mode 1, ISN 10Mbps

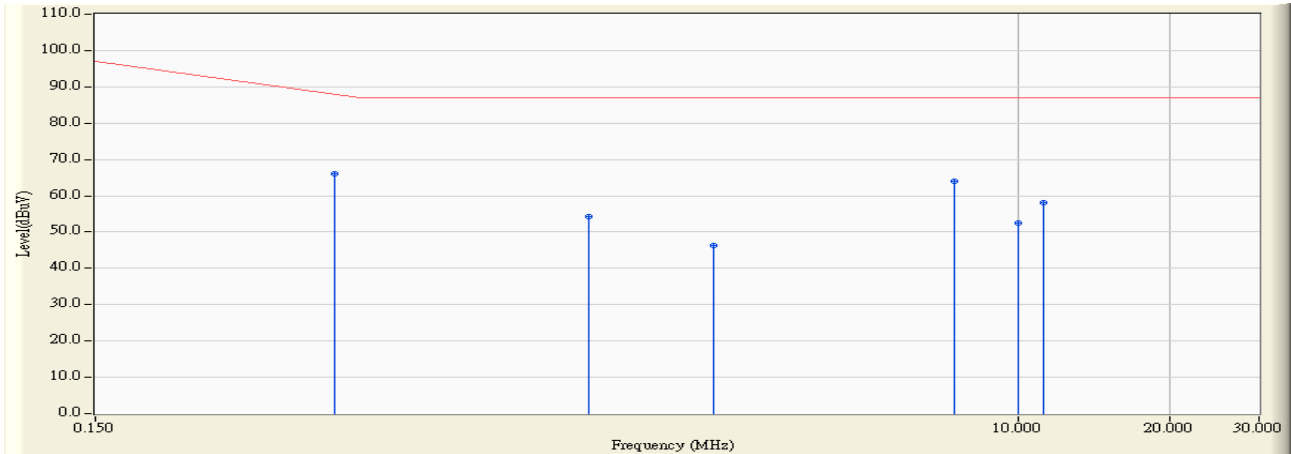

		Frequency (MHz)	Correct Factor (dB)	Reading Level (dBuV)	Measure Level (dBuV)	Margin (dB)	Limit (dBuV)	Detector Type
1	*	0.447	10.000	56.200	66.200	-22.314	88.514	QUASIPeAK
2		1.416	9.990	44.190	54.180	-32.820	87.000	QUASIPeAK
3		2.502	10.000	36.420	46.420	-40.580	87.000	QUASIPeAK
4		7.502	9.970	53.980	63.950	-23.050	87.000	QUASIPeAK
5		10.000	9.960	42.560	52.520	-34.480	87.000	QUASIPeAK
6		11.252	9.960	48.170	58.130	-28.870	87.000	QUASIPeAK

**Note:**

1. All Reading Levels are Quasi-Peak and average value.
2. " \* ", means this data is the worst emission level.
3. Measurement Level = Reading Level + Correct Factor

Site : SR1	Time : 2009/09/25 - 14:35
Limit : ISN_Voltage_A_00M_AV	Margin : 0
EUT : Network Camera	Probe : ISN_T4 - Line1
Power : AC 230V/50Hz	Note : Mode 1, ISN 10Mbps

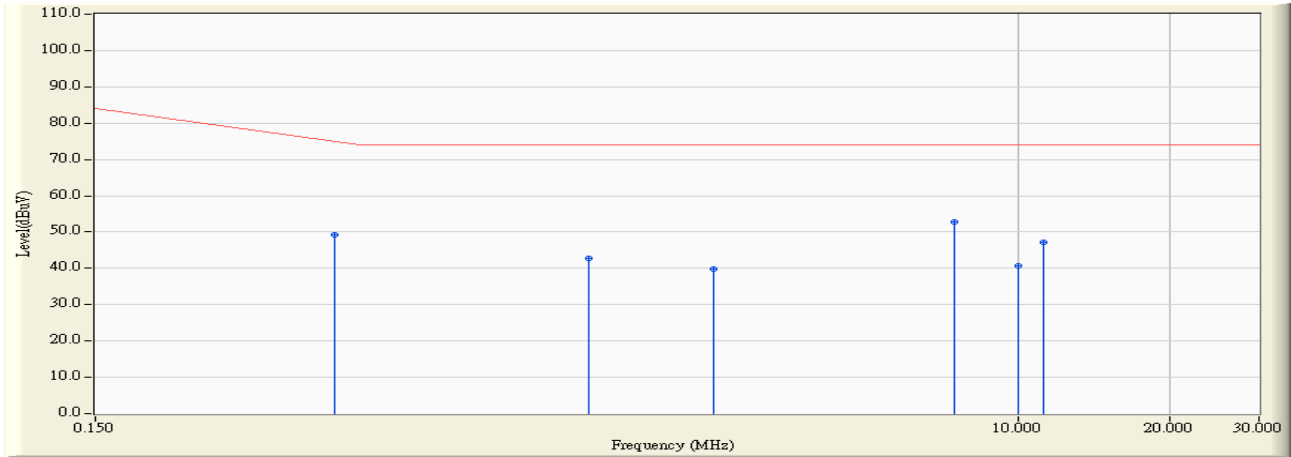

		Frequency (MHz)	Correct Factor (dB)	Reading Level (dBuV)	Measure Level (dBuV)	Margin (dB)	Limit (dBuV)	Detector Type
1		0.447	10.000	39.370	49.370	-26.144	75.514	AVERAGE
2		1.416	9.990	32.730	42.720	-31.280	74.000	AVERAGE
3		2.502	10.000	29.670	39.670	-34.330	74.000	AVERAGE
4	*	7.502	9.970	42.820	52.790	-21.210	74.000	AVERAGE
5		10.000	9.960	30.800	40.760	-33.240	74.000	AVERAGE
6		11.252	9.960	37.100	47.060	-26.940	74.000	AVERAGE

**Note:**

1. All Reading Levels are Quasi-Peak and average value.
2. " \* ", means this data is the worst emission level.
3. Measurement Level = Reading Level + Correct Factor

Site : SR1	Time : 2009/09/25 - 14:34
Limit : ISN_Voltage_A_00M_QP	Margin : 10
EUT : Network Camera	Probe : ISN_T4 - Line1
Power : AC 230V/50Hz	Note : Mode 1, ISN 100Mbps

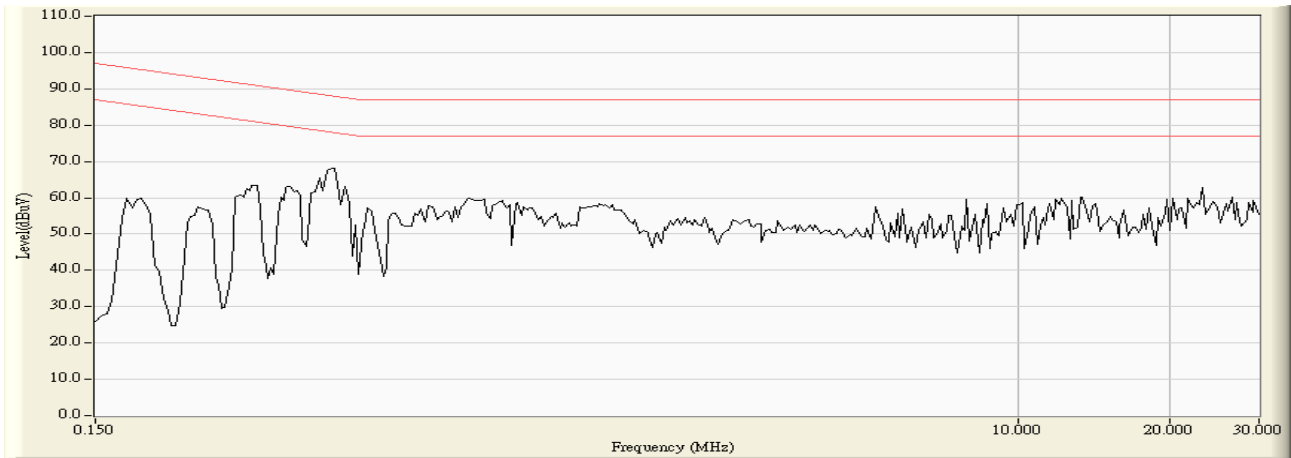

Site : SR1	Time : 2009/09/25 - 14:34
Limit : ISN_Voltage_A_00M_QP	Margin : 0
EUT : Network Camera	Probe : ISN_T4 - Line1
Power : AC 230V/50Hz	Note : Mode 1, ISN 100Mbps

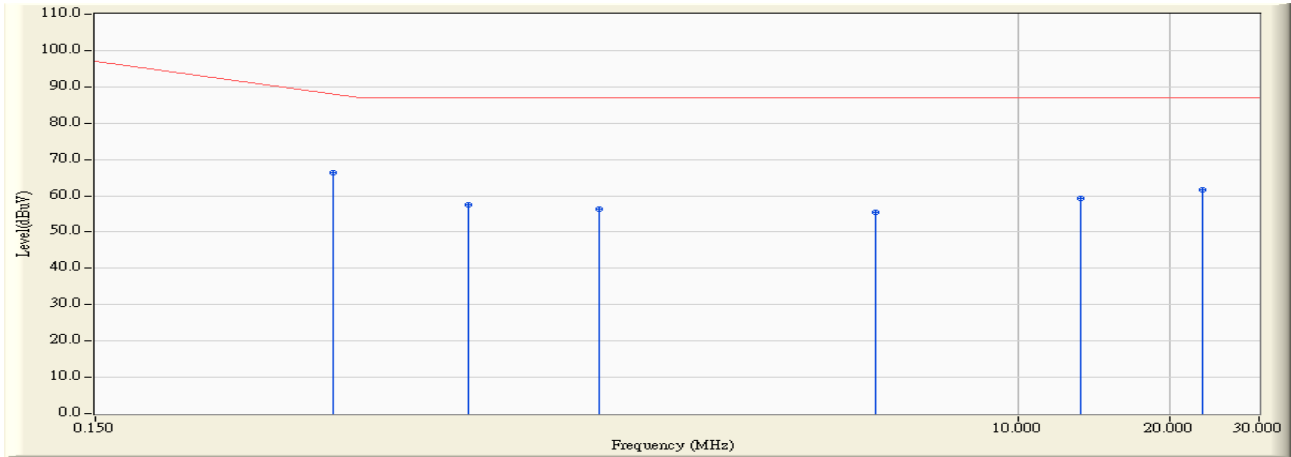

		Frequency (MHz)	Correct Factor (dB)	Reading Level (dBuV)	Measure Level (dBuV)	Margin (dB)	Limit (dBuV)	Detector Type
1	*	0.443	10.000	56.330	66.330	-22.299	88.629	QUASIPeAK
2		0.822	9.980	47.630	57.610	-29.390	87.000	QUASIPeAK
3		1.490	9.990	46.390	56.380	-30.620	87.000	QUASIPeAK
4		5.236	9.980	45.540	55.520	-31.480	87.000	QUASIPeAK
5		13.357	10.150	49.160	59.310	-27.690	87.000	QUASIPeAK
6		23.130	10.100	51.680	61.780	-25.220	87.000	QUASIPeAK

**Note:**

1. All Reading Levels are Quasi-Peak and average value.
2. " \* ", means this data is the worst emission level.
3. Measurement Level = Reading Level + Correct Factor

Site : SR1	Time : 2009/09/25 - 14:34
Limit : ISN_Voltage_A_00M_AV	Margin : 0
EUT : Network Camera	Probe : ISN_T4 - Line1
Power : AC 230V/50Hz	Note : Mode 1, ISN 100Mbps

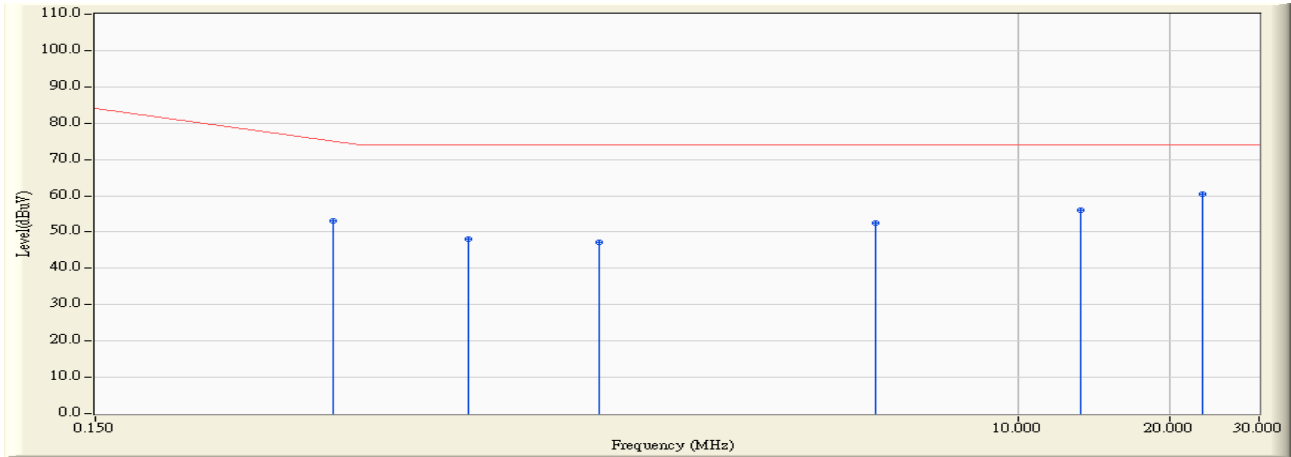

		Frequency (MHz)	Correct Factor (dB)	Reading Level (dBuV)	Measure Level (dBuV)	Margin (dB)	Limit (dBuV)	Detector Type
1		0.443	10.000	43.130	53.130	-22.499	75.629	AVERAGE
2		0.822	9.980	38.090	48.070	-25.930	74.000	AVERAGE
3		1.490	9.990	37.200	47.190	-26.810	74.000	AVERAGE
4		5.236	9.980	42.490	52.470	-21.530	74.000	AVERAGE
5		13.357	10.150	45.910	56.060	-17.940	74.000	AVERAGE
6	*	23.130	10.100	50.390	60.490	-13.510	74.000	AVERAGE

**Note:**

1. All Reading Levels are Quasi-Peak and average value.
2. " \* ", means this data is the worst emission level.
3. Measurement Level = Reading Level + Correct Factor

Site : SR1	Time : 2009/09/25 - 14:35
Limit : ISN_Voltage_A_00M_QP	Margin : 10
EUT : Network Camera	Probe : CVP-2200A - Line1
Power : AC 230V/50Hz	Note : Mode 2, ISN 10Mbps

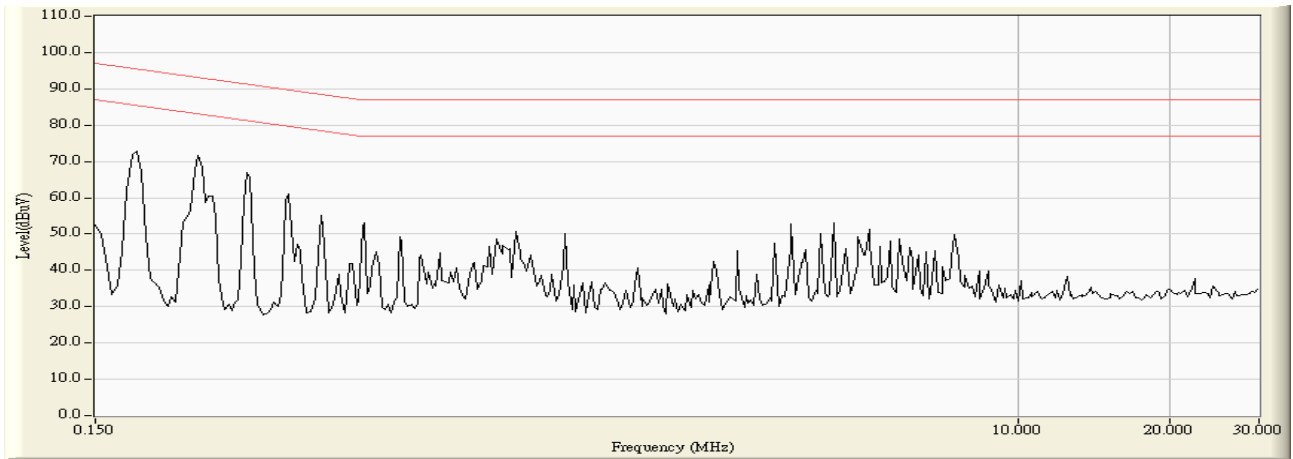



Site : SR1	Time : 2009/09/25 - 14:41
Limit : ISN_Voltage_A_00M_QP	Margin : 0
EUT : Network Camera	Probe : CVP-2200A - Line1
Power : AC 230V/50Hz	Note : Mode 2, ISN 10Mbps

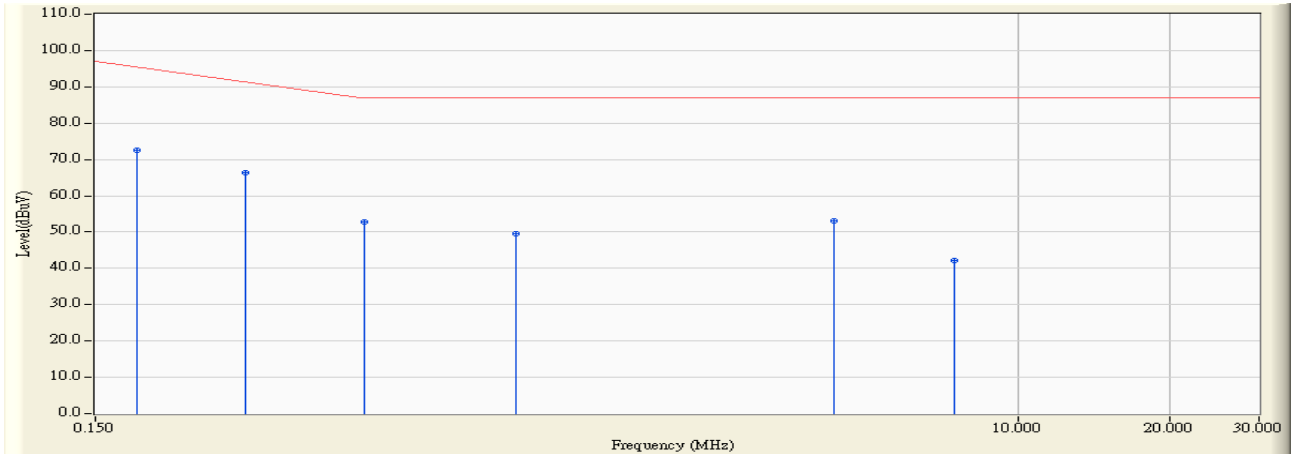

		Frequency (MHz)	Correct Factor (dB)	Reading Level (dBuV)	Measure Level (dBuV)	Margin (dB)	Limit (dBuV)	Detector Type
1	*	0.181	20.200	52.410	72.610	-23.504	96.114	QUASIPeAK
2		0.298	20.200	46.150	66.350	-26.421	92.771	QUASIPeAK
3		0.509	20.200	32.610	52.810	-34.190	87.000	QUASIPeAK
4		1.017	20.200	29.210	49.410	-37.590	87.000	QUASIPeAK
5		4.318	20.200	33.000	53.200	-33.800	87.000	QUASIPeAK
6		7.502	20.200	21.950	42.150	-44.850	87.000	QUASIPeAK

**Note:**

1. All Reading Levels are Quasi-Peak and average value.
2. " \* ", means this data is the worst emission level.
3. Measurement Level = Reading Level + Correct Factor

Site : SR1	Time : 2009/09/25 - 14:41
Limit : ISN_Voltage_A_00M_AV	Margin : 0
EUT : Network Camera	Probe : CVP-2200A - Line1
Power : AC 230V/50Hz	Note : Mode 2, ISN 10Mbps

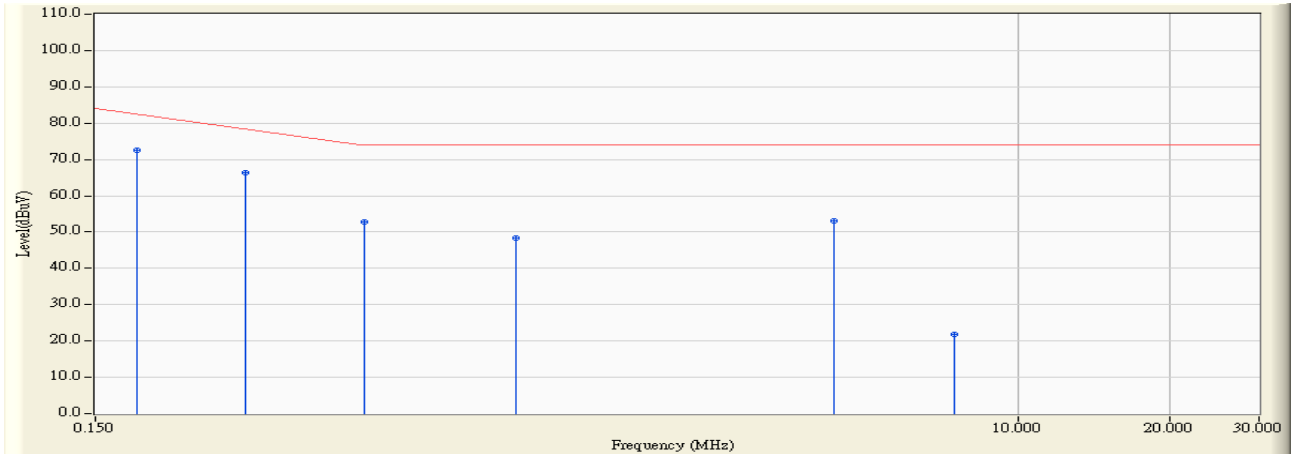

		Frequency (MHz)	Correct Factor (dB)	Reading Level (dBuV)	Measure Level (dBuV)	Margin (dB)	Limit (dBuV)	Detector Type
1	*	0.181	20.200	52.400	72.600	-10.514	83.114	AVERAGE
2		0.298	20.200	46.140	66.340	-13.431	79.771	AVERAGE
3		0.509	20.200	32.600	52.800	-21.200	74.000	AVERAGE
4		1.017	20.200	28.030	48.230	-25.770	74.000	AVERAGE
5		4.318	20.200	32.990	53.190	-20.810	74.000	AVERAGE
6		7.502	20.200	1.530	21.730	-52.270	74.000	AVERAGE

**Note:**

1. All Reading Levels are Quasi-Peak and average value.
2. " \* ", means this data is the worst emission level.
3. Measurement Level = Reading Level + Correct Factor

Site : SR1	Time : 2009/09/25 - 14:41
Limit : ISN_Voltage_A_00M_QP	Margin : 10
EUT : Network Camera	Probe : CVP-2200A - Line1
Power : AC 230V/50Hz	Note : Mode 2, ISN 100Mbps

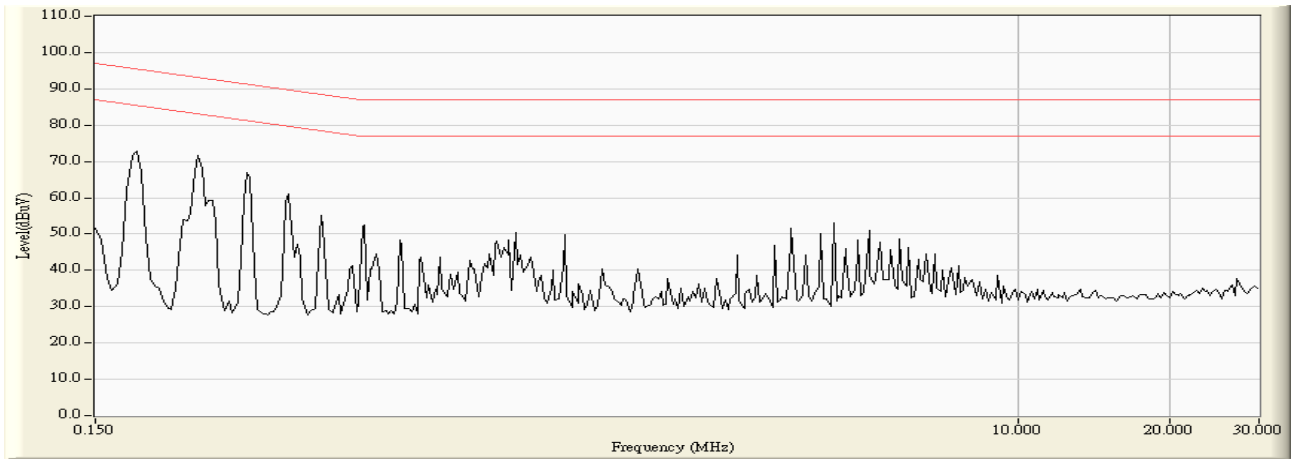

Site : SR1	Time : 2009/09/25 - 14:41
Limit : ISN_Voltage_A_00M_QP	Margin : 0
EUT : Network Camera	Probe : CVP-2200A - Line1
Power : AC 230V/50Hz	Note : Mode 2, ISN 100Mbps

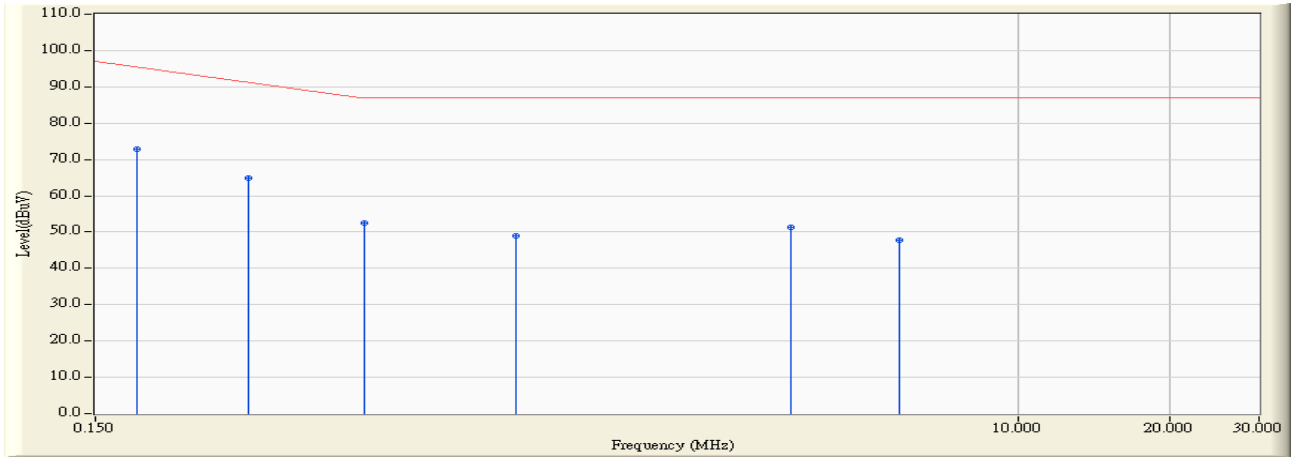

		Frequency (MHz)	Correct Factor (dB)	Reading Level (dBuV)	Measure Level (dBuV)	Margin (dB)	Limit (dBuV)	Detector Type
1	*	0.181	20.200	52.520	72.720	-23.394	96.114	QUASIPeAK
2		0.302	20.200	44.770	64.970	-27.687	92.657	QUASIPeAK
3		0.509	20.200	32.200	52.400	-34.600	87.000	QUASIPeAK
4		1.017	20.200	28.860	49.060	-37.940	87.000	QUASIPeAK
5		3.556	20.200	31.200	51.400	-35.600	87.000	QUASIPeAK
6		5.841	20.200	27.620	47.820	-39.180	87.000	QUASIPeAK

**Note:**

1. All Reading Levels are Quasi-Peak and average value.
2. " \* ", means this data is the worst emission level.
3. Measurement Level = Reading Level + Correct Factor

Site : SR1	Time : 2009/09/25 - 14:42
Limit : ISN_Voltage_A_00M_AV	Margin : 0
EUT : Network Camera	Probe : CVP-2200A - Line1
Power : AC 230V/50Hz	Note : Mode 2, ISN 100Mbps

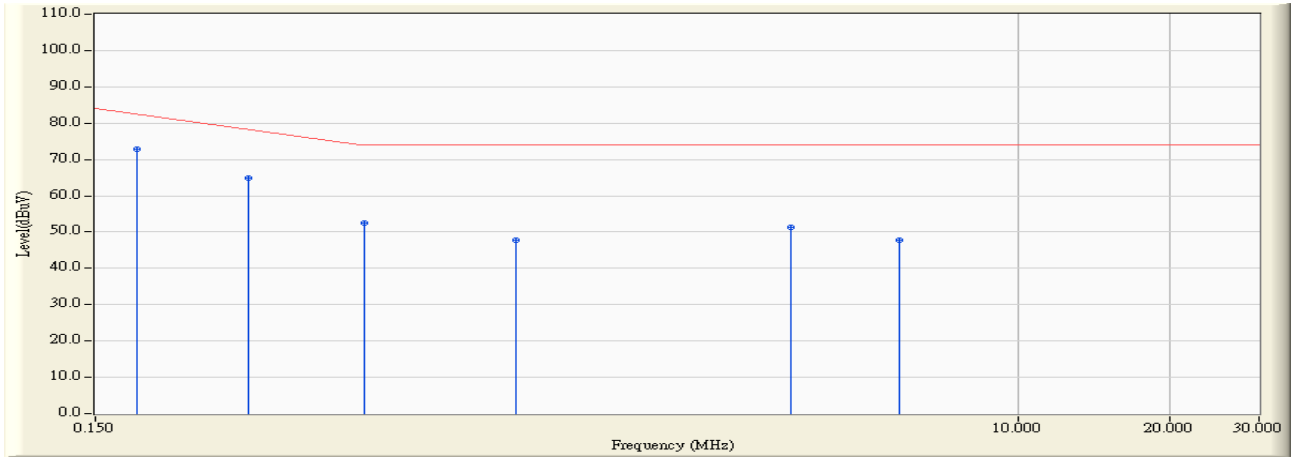

		Frequency (MHz)	Correct Factor (dB)	Reading Level (dBuV)	Measure Level (dBuV)	Margin (dB)	Limit (dBuV)	Detector Type
1	*	0.181	20.200	52.510	72.710	-10.404	83.114	AVERAGE
2		0.302	20.200	44.760	64.960	-14.697	79.657	AVERAGE
3		0.509	20.200	32.190	52.390	-21.610	74.000	AVERAGE
4		1.017	20.200	27.520	47.720	-26.280	74.000	AVERAGE
5		3.556	20.200	31.190	51.390	-22.610	74.000	AVERAGE
6		5.841	20.200	27.610	47.810	-26.190	74.000	AVERAGE

**Note:**

1. All Reading Levels are Quasi-Peak and average value.
2. " \* ", means this data is the worst emission level.
3. Measurement Level = Reading Level + Correct Factor

## 4.7. Test Photograph

Test Mode : Mode 1: Normal Operation (Adapter)

Description : Front View of ISN Test



Test Mode : Mode 1: Normal Operation (Adapter)

Description : Back View of ISN Test



Test Mode : Mode 2: Normal Operation (PoE)

Description : Front View of ISN Test



Test Mode : Mode 2: Normal Operation (PoE)

Description : Back View of ISN Test



**5. Radiated Emission**

**5.1. Test Specification**

According to EMC Standard : EN 55022 and AS/NZS CISPR 22

**5.2. Test Setup**

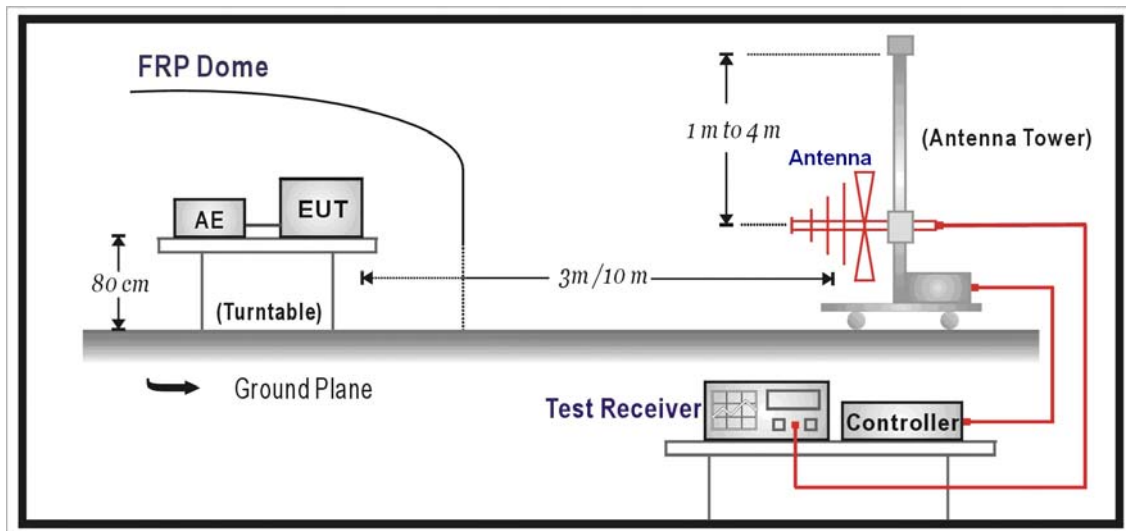

**5.3. Limit**

Limits		
Frequency MHz	Distance (m)	dBuV/m
30 – 230	10	40
230 – 1000	10	47

Remark:

1. The tighter limit shall apply at the edge between two frequency bands.
2. Distance refers to the distance in meters between the measuring instrument antenna and the closed point of any part of the device or system.



#### **5.4. Test Procedure**

The EUT and its simulators are placed on a turn table which is 0.8 meter above ground. The turn table can rotate 360 degrees to determine the position of the maximum emission level. The EUT was positioned such that the distance from antenna to the EUT was 10 meters. The antenna can move up and down between 1 meter and 4 meters to find out the maximum emission level.

Both horizontal and vertical polarization of the antenna are set on measurement. In order to find the maximum emission, all of the interface cables must be manipulated on radiated measurement.

Radiated emissions were investigated over the frequency range from 30MHz to 1GHz using a receiver bandwidth of 120kHz. Radiated was performed at an antenna to EUT distance of 10 meters.

#### **5.5. Deviation from Test Standard**

No deviation.

5.6. Test Result

Site : OATS-3	Time : 2009/09/25 - 09:26
Limit : CISPR_A_10M_QP	Margin : 6
EUT : Network Camera	Probe : Site3_CBL6112_10M_0811 - HORIZONTAL
Power : AC 230V/50Hz	Note : Mode 1

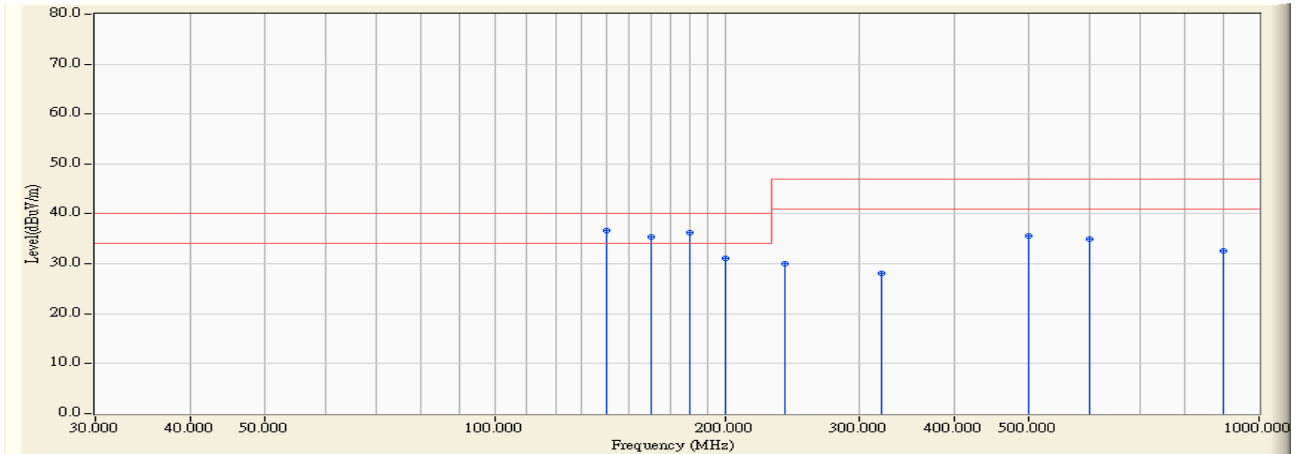

		Frequency (MHz)	Correct Factor (dB)	Reading Level (dBuV)	Measure Level (dBuV/m)	Margin (dB)	Limit (dBuV/m)	Detector Type
1	*	140.000	14.430	22.160	36.590	-3.410	40.000	QUASIPeAK
2		160.000	13.209	22.081	35.290	-4.710	40.000	QUASIPeAK
3		180.000	12.427	23.737	36.164	-3.836	40.000	QUASIPeAK
4		200.000	12.743	18.400	31.143	-8.857	40.000	QUASIPeAK
5		240.000	15.590	14.395	29.985	-17.015	47.000	QUASIPeAK
6		320.000	17.939	10.080	28.019	-18.981	47.000	QUASIPeAK
7		500.032	22.066	13.515	35.581	-11.419	47.000	QUASIPeAK
8		600.019	23.776	11.150	34.926	-12.074	47.000	QUASIPeAK
9		900.022	27.659	4.960	32.619	-14.381	47.000	QUASIPeAK

Note:

1. All Readings below 1GHz are Quasi-Peak, above are performed with peak and/or average measurements as necessary.
2. " \* ", means this data is the worst emission level.
3. Measurement Level = Reading Level + Correct Factor

Site : OATS-3	Time : 2009/09/25 - 09:42
Limit : CISPR_A_10M_QP	Margin : 6
EUT : Network Camera	Probe : Site3_CBL6112_10M_0811 - VERTICAL
Power : AC 230V/50Hz	Note : Mode 1

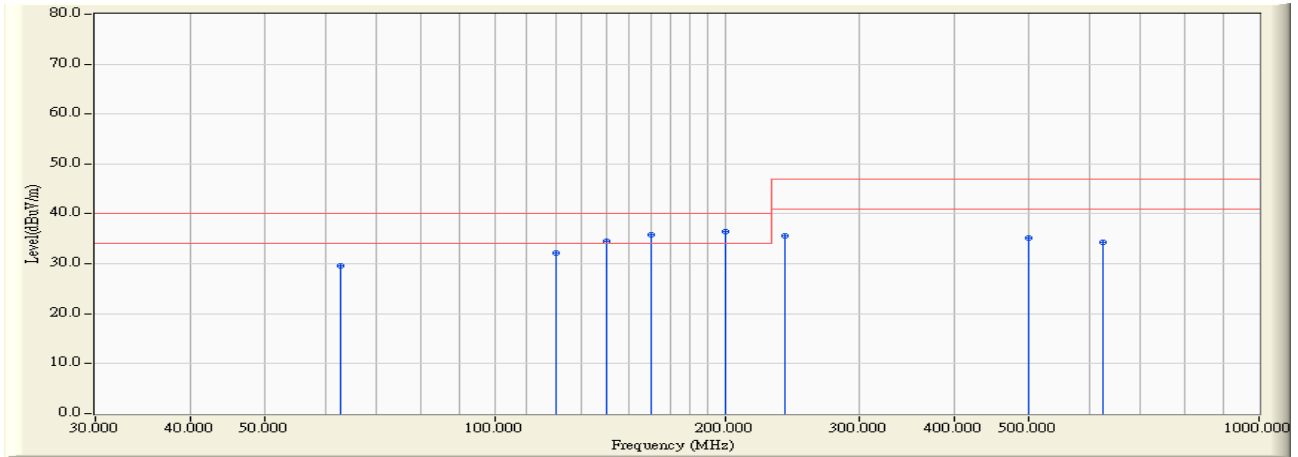

		Frequency (MHz)	Correct Factor (dB)	Reading Level (dBuV)	Measure Level (dBuV/m)	Margin (dB)	Limit (dBuV/m)	Detector Type
1		62.700	7.925	21.725	29.650	-10.350	40.000	QUASIPeAK
2		120.000	15.180	16.931	32.111	-7.889	40.000	QUASIPeAK
3		140.016	14.429	20.151	34.580	-5.420	40.000	QUASIPeAK
4		160.000	13.209	22.661	35.870	-4.130	40.000	QUASIPeAK
5	*	200.000	12.743	23.800	36.543	-3.457	40.000	QUASIPeAK
6		240.000	15.590	20.095	35.685	-11.315	47.000	QUASIPeAK
7		500.030	22.066	13.215	35.281	-11.719	47.000	QUASIPeAK
8		625.042	24.054	10.190	34.244	-12.756	47.000	QUASIPeAK

**Note:**

1. All Readings below 1GHz are Quasi-Peak, above are performed with peak and/or average measurements as necessary.
2. " \* ", means this data is the worst emission level.
3. Measurement Level = Reading Level + Correct Factor

Site : OATS-3	Time : 2009/09/22 - 15:36
Limit : CISPR_A_10M_QP	Margin : 6
EUT : Network Camera	Probe : Site3_CBL6112_10M_0811 - HORIZONTAL
Power : DC 48V	Note : Mode 2

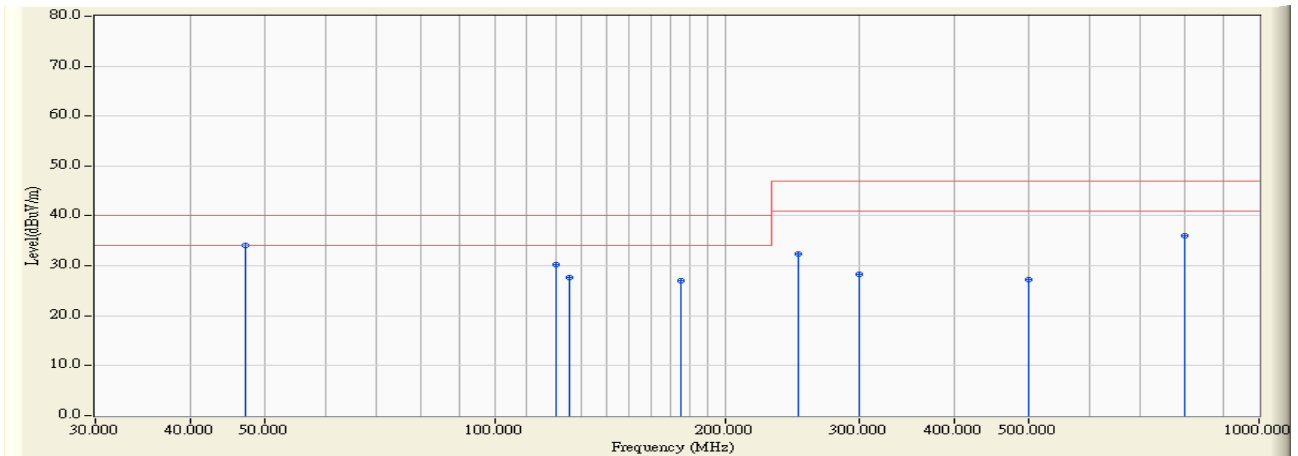

		Frequency (MHz)	Correct Factor (dB)	Reading Level (dBuV)	Measure Level (dBuV/m)	Margin (dB)	Limit (dBuV/m)	Detector Type
1	*	47.100	12.809	21.350	34.159	-5.841	40.000	QUASIPeAK
2		120.000	15.180	15.146	30.326	-9.674	40.000	QUASIPeAK
3		125.000	15.012	12.625	27.637	-12.363	40.000	QUASIPeAK
4		175.450	12.601	14.344	26.946	-13.054	40.000	QUASIPeAK
5		250.008	16.299	16.013	32.312	-14.688	47.000	QUASIPeAK
6		300.008	17.401	10.936	28.337	-18.663	47.000	QUASIPeAK
7		500.021	22.066	5.200	27.266	-19.734	47.000	QUASIPeAK
8		800.000	26.318	9.782	36.100	-10.900	47.000	QUASIPeAK

**Note:**

1. All Readings below 1GHz are Quasi-Peak, above are performed with peak and/or average measurements as necessary.
2. " \* ", means this data is the worst emission level.
3. Measurement Level = Reading Level + Correct Factor

Site : OATS-3	Time : 2009/09/22 - 15:59
Limit : CISPR_A_10M_QP	Margin : 6
EUT : Network Camera	Probe : Site3_CBL6112_10M_0811 - VERTICAL
Power : DC 48V	Note : Mode 2

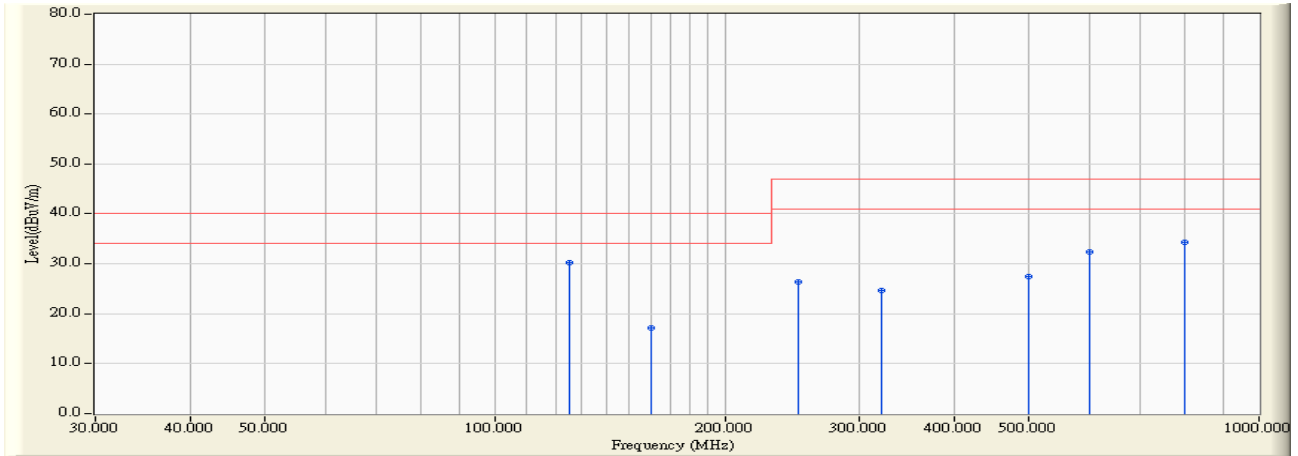

		Frequency (MHz)	Correct Factor (dB)	Reading Level (dBuV)	Measure Level (dBuV/m)	Margin (dB)	Limit (dBuV/m)	Detector Type
1	*	125.000	15.012	15.125	30.137	-9.863	40.000	QUASIPeAK
2		160.000	13.209	3.891	17.100	-22.900	40.000	QUASIPeAK
3		250.008	16.299	9.985	26.284	-20.716	47.000	QUASIPeAK
4		320.002	17.939	6.629	24.568	-22.432	47.000	QUASIPeAK
5		500.021	22.066	5.467	27.533	-19.467	47.000	QUASIPeAK
6		600.012	23.776	8.577	32.353	-14.647	47.000	QUASIPeAK
7		800.000	26.318	7.919	34.237	-12.763	47.000	QUASIPeAK

**Note:**

1. All Readings below 1GHz are Quasi-Peak, above are performed with peak and/or average measurements as necessary.
2. " \* ", means this data is the worst emission level.
3. Measurement Level = Reading Level + Correct Factor

**5.7. Test Photograph**

Test Mode : Mode 1: Normal Operation (Adapter)

Description : Front View of Radiated Test



Test Mode : Mode 1: Normal Operation (Adapter)

Description : Back View of Radiated Test



Test Mode : Mode 2: Normal Operation (PoE)

Description : Front View of Radiated Test



Test Mode : Mode 2: Normal Operation (PoE)

Description : Back View of Radiated Test



## 6. Harmonic Current Emission

### 6.1. Test Specification

According to EMC Standard : EN 61000-3-2

### 6.2. Test Setup

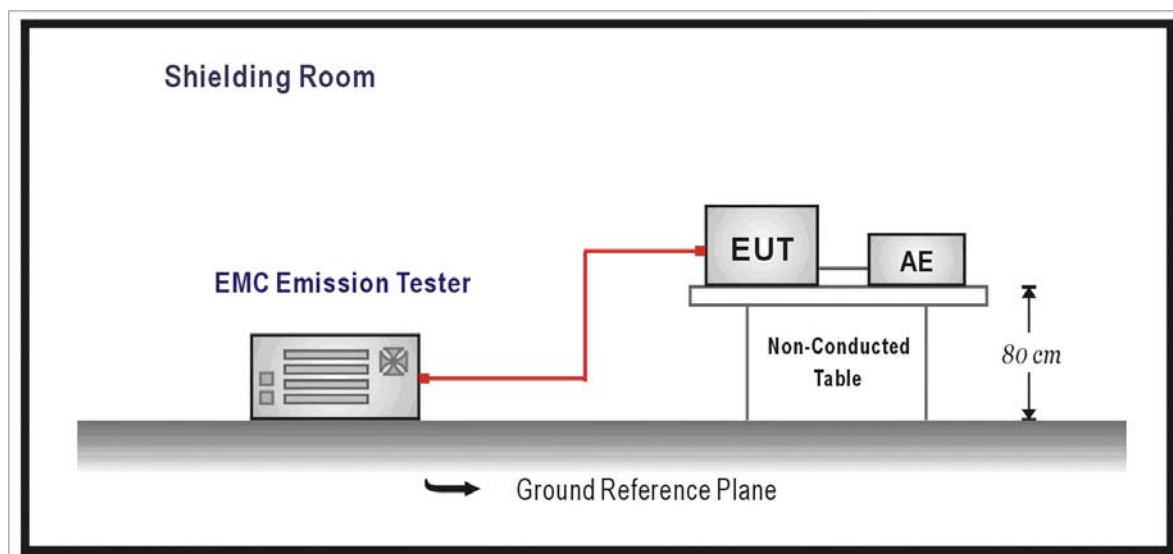

### 6.3. Limit

(a) Limits of Class A Harmonics Currents

Harmonics Order n	Maximum Permissible harmonic current A	Harmonics Order n	Maximum Permissible harmonic current A
Odd harmonics		Even harmonics	
3	2.30	2	1.08
5	1.14	4	0.43
7	0.77	6	0.30
9	0.40	8 ≤ n ≤ 40	0.23 * 8/n
11	0.33		
13	0.21		
15 ≤ n ≤ 39	0.15 * 15/n		



(b) Limits of Class B Harmonics Currents

For Class B equipment, the harmonic of the input current shall not exceed the maximum permissible values given in table that is the limit of Class A multiplied by a factor of 1.5.

(c) Limits of Class C Harmonics Currents

Harmonics Order n	Maximum Permissible harmonic current Expressed as a percentage of the input current at the fundamental frequency %
2	2
3	$30 \cdot \lambda^*$
5	10
7	7
9	5
$11 \leq n \leq 39$ (odd harmonics only)	3

\*  $\lambda$  is the circuit power factor

(d) Limits of Class D Harmonics Currents

Harmonics Order n	Maximum Permissible harmonic current per watt mA/W	Maximum Permissible harmonic current A
3	3.4	2.30
5	1.9	1.14
7	1.0	0.77
9	0.5	0.40
11	0.35	0.33
$11 \leq n \leq 39$ (odd harmonics only)	$3.85/n$	See limit of Class A

**6.4. Test Procedure**

The EUT is supplied in series with power analyzer from a power source having the same normal voltage and frequency as the rated supply voltage and the equipment under test. And the rated voltage at the supply voltage of EUT of 0.94 times and 1.06 times shall be performed.

**6.5. Deviation from Test Standard**

No deviation.

6.6. Test Result

Product	Network Camera		
Test Item	Power Harmonics		
Test Mode	Mode 1: Normal Operation (Adapter)		
Date of Test	2009/10/06	Test Site	No.3 Shielded Room

Test Result: Pass                      Source qualification: Normal

Current & voltage waveforms

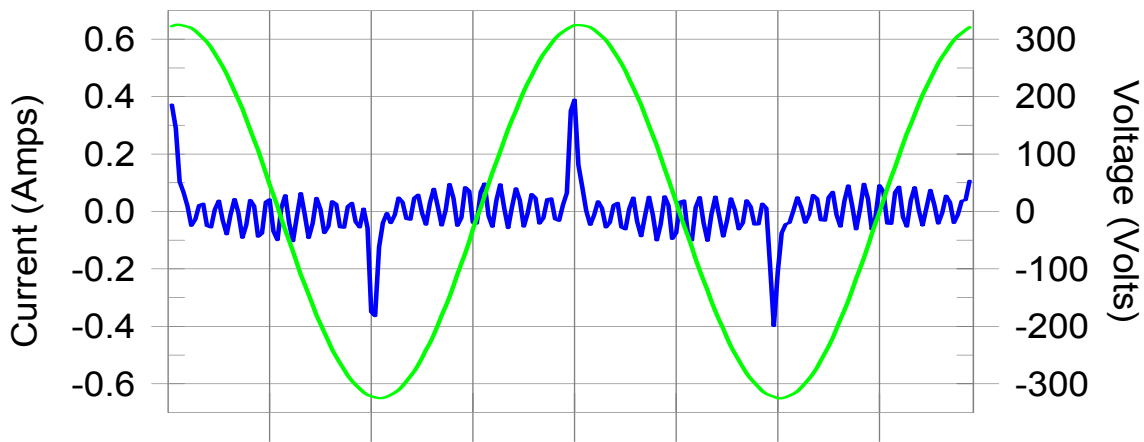

Harmonics and Class A limit line

European Limits

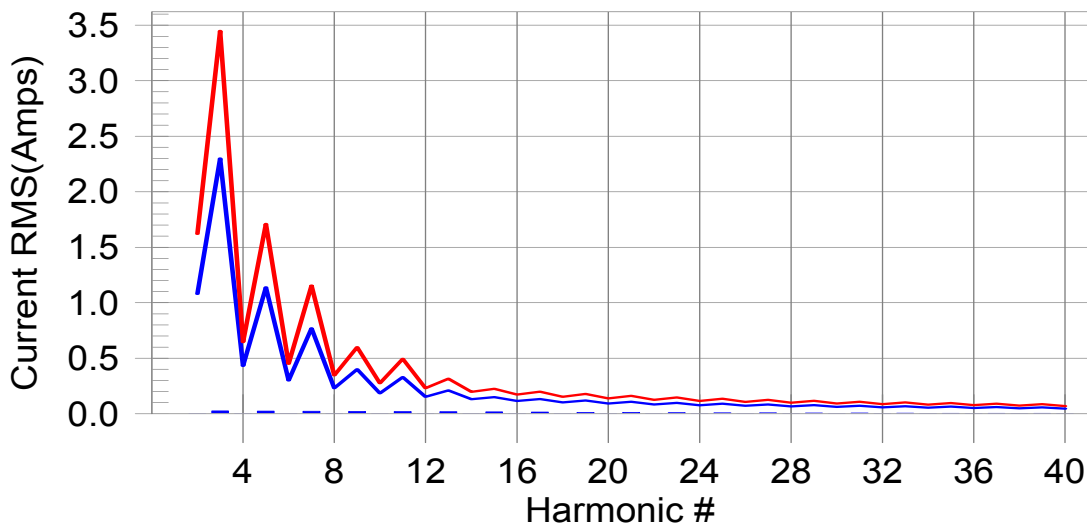

Test result: Pass                      Worst harmonic was #17 with 11.17% of the limit.

Test Result: Pass                      Source qualification: Normal  
 THC(A): 0.06                      I-THD(%): 211.08                      POHC(A): 0.023                      POHC Limit(A): 0.251  
 Highest parameter values during test:

V_RMS (Volts):	229.75	Frequency(Hz):	50.00
I_Peak (Amps):	0.458	I_RMS (Amps):	0.086
I_Fund (Amps):	0.031	Crest Factor:	5.416
Power (Watts):	6.0	Power Factor:	0.302

Harm#	Harms(avg)	100%Limit	%of Limit	Harms(max)	150%Limit	%of Limit	Status
2	0.001	1.080	0.1	0.001	1.620	0.04	Pass
3	0.025	2.300	1.1	0.025	3.450	0.72	Pass
4	0.001	0.430	0.2	0.001	0.645	0.12	Pass
5	0.024	1.140	2.1	0.024	1.710	1.41	Pass
6	0.001	0.300	0.2	0.001	0.450	0.17	Pass
7	0.023	0.770	3.0	0.023	1.155	2.00	Pass
8	0.001	0.230	0.3	0.001	0.345	0.24	Pass
9	0.021	0.400	5.4	0.022	0.600	3.62	Pass
10	0.001	0.184	0.4	0.001	0.276	0.31	Pass
11	0.020	0.330	6.0	0.020	0.495	4.08	Pass
12	0.001	0.153	0.5	0.001	0.230	0.42	Pass
13	0.018	0.210	8.7	0.018	0.315	5.87	Pass
14	0.001	0.131	0.6	0.001	0.197	0.46	Pass
15	0.017	0.150	11.0	0.017	0.225	7.45	Pass
16	0.001	0.115	0.7	0.001	0.173	0.51	Pass
17	0.015	0.132	11.2	0.015	0.199	7.53	Pass
18	0.001	0.102	0.8	0.001	0.153	0.60	Pass
19	0.013	0.118	11.0	0.013	0.178	7.47	Pass
20	0.001	0.092	0.8	0.001	0.138	0.61	Pass
21	0.011	0.107	10.7	0.012	0.161	7.26	Pass
22	0.001	0.084	0.9	0.001	0.125	0.67	Pass
23	0.010	0.098	10.3	0.010	0.147	7.00	Pass
24	0.001	0.077	0.9	0.001	0.115	0.68	Pass
25	0.009	0.090	9.8	0.009	0.135	6.68	Pass
26	0.001	0.071	0.9	0.001	0.106	0.71	Pass
27	0.008	0.083	9.4	0.008	0.125	6.37	Pass
28	0.001	0.066	0.9	0.001	0.099	0.71	Pass
29	0.007	0.078	8.9	0.007	0.116	6.10	Pass
30	0.001	0.061	0.9	0.001	0.092	0.77	Pass
31	0.006	0.073	8.5	0.006	0.109	5.80	Pass
32	0.001	0.058	0.9	0.001	0.086	0.75	Pass
33	0.006	0.068	8.1	0.006	0.102	5.52	Pass
34	0.000	0.054	0.9	0.001	0.081	0.76	Pass
35	0.005	0.064	7.7	0.005	0.096	5.26	Pass
36	0.000	0.051	0.9	0.001	0.077	0.75	Pass
37	0.004	0.061	7.2	0.004	0.091	4.91	Pass
38	0.000	0.048	0.9	0.001	0.073	0.75	Pass
39	0.004	0.058	6.6	0.004	0.087	4.50	Pass
40	0.000	0.046	0.9	0.001	0.069	0.75	Pass

1.Dynamic limits were applied for this test. The highest harmonics values in the above table may not occur at the same window as the maximum harmonics/limit ratio.

2:According to EN61000-3-2 paragraph 7 the note 1 and 2 are valid for all applications having an active input power >75W. Others the result should be pass.

## 6.7. Test Photograph

Test Mode : Mode 1: Normal Operation (Adapter)

Description : Power Harmonics Test Setup



## 7. Voltage Fluctuation and Flicker

### 7.1. Test Specification

According to EMC Standard : EN 61000-3-3

### 7.2. Test Setup

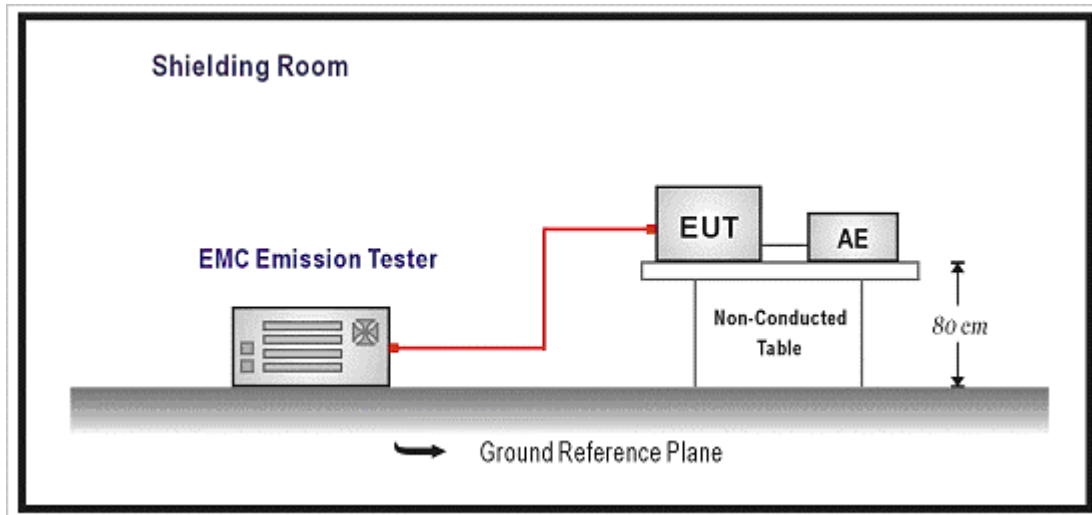

### 7.3. Limit

The following limits apply:

- the value of  $P_{st}$  shall not be greater than 1.0;
- the value of  $P_{1t}$  shall not be greater than 0.65;
- the value of  $d(t)$  during a voltage change shall not exceed 3.3 % for more than 500 ms;
- the relative steady-state voltage change,  $d_c$ , shall not exceed 3.3 %;
- the maximum relative voltage change,  $d_{max}$ , shall not exceed;
  - a) 4 % without additional conditions;
  - b) 6 % for equipment which is:
    - switched manually, or
    - switched automatically more frequently than twice per day, and also has either a delayed restart (the delay being not less than a few tens of seconds), or manual restart, after a power supply interruption.

NOTE The cycling frequency will be further limited by the  $P_{st}$  and  $P_{1t}$  limit.

For example: a  $d_{max}$  of 6% producing a rectangular voltage change characteristic twice per hour will give a  $P_{1t}$  of about 0.65.

- c) 7 % for equipment which is:
- attended whilst in use (for example: hair dryers, vacuum cleaners, kitchen equipment such as mixers, garden equipment such as lawn mowers, portable tools such as electric drills), or
  - switched on automatically, or is intended to be switched on manually, no more than twice per day, and also has either a delayed restart (the delay being not less than a few tens of seconds) or manual restart, after a power supply interruption.

$P_{st}$  and  $P_{1t}$  requirements shall not be applied to voltage changes caused by manual switching.

#### **7.4. Test Procedure**

The EUT is supplied in series with power analyzer from a power source having the same normal voltage and frequency as the rated supply voltage and the equipment under test. And the rated voltage at the supply voltage of EUT of 0.94 times and 1.06 times shall be performed.

#### **7.5. Deviation from Test Standard**

No deviation.

## 7.6. Test Result

Product	Network Camera		
Test Item	Voltage Fluctuation and Flicker		
Test Mode	Mode 1: Normal Operation (Adapter)		
Date of Test	2009/09/29	Test Site	No.3 Shielded Room

Test Result: Pass

Status: Test Completed

Pst<sub>j</sub> and limit line

European Limits

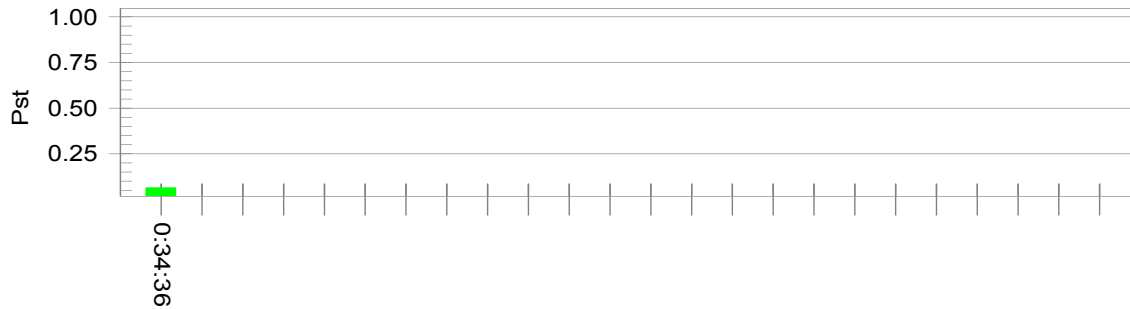

Plt and limit line

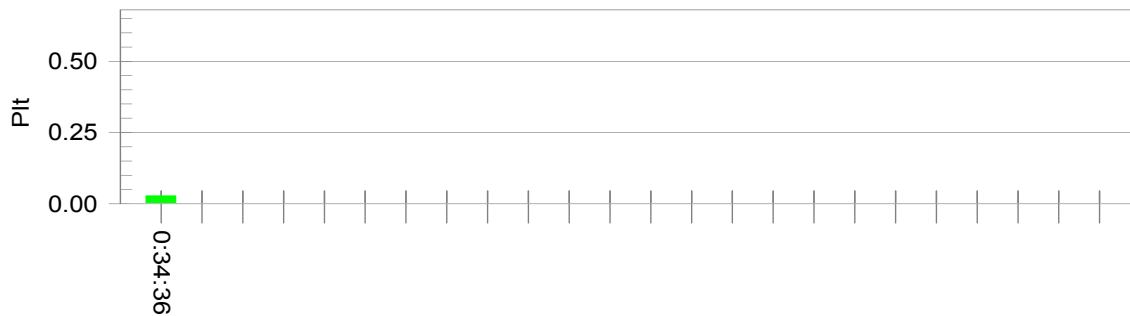

Parameter values recorded during the test:

Vrms at the end of test (Volt):	229.66		
Highest dt (%):	0.00	Test limit (%):	3.30 Pass
Time(mS) > dt:	0.0	Test limit (mS):	500.0 Pass
Highest dc (%):	0.00	Test limit (%):	3.30 Pass
Highest dmax (%):	0.00	Test limit (%):	4.00 Pass
Highest Pst (10 min. period):	0.064	Test limit:	1.000 Pass
Highest Plt (2 hr. period):	0.028	Test limit:	0.650 Pass



## 7.7. Test Photograph

Test Mode : Mode 1: Normal Operation (Adapter)

Description : Flicker Test Setup



## 8. Electrostatic Discharge

### 8.1. Test Specification

According to Standard : IEC 61000-4-2

### 8.2. Test Setup

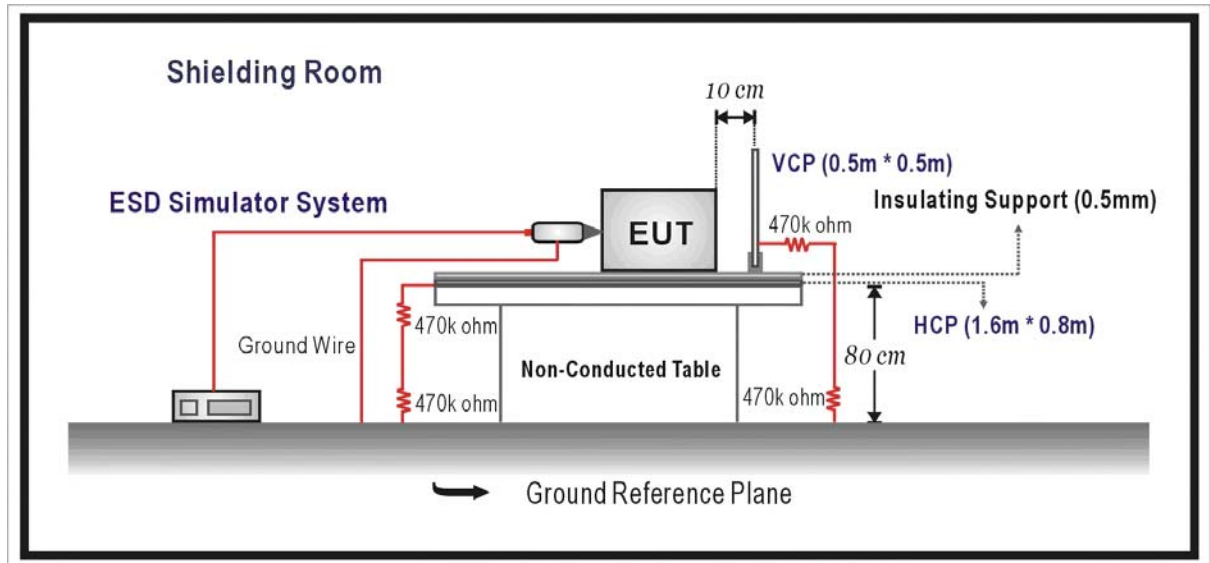

### 8.3. Limit

Item	Environmental Phenomena	Units	Test Specification	Performance Criteria
Enclosure Port				
	Electrostatic Discharge	kV(Charge Voltage)	±8 Air Discharge ±4 Contact Discharge	B

## 8.4. Test Procedure

Direct application of discharges to the EUT:

Contact discharge was applied only to conductive surfaces of the EUT.

Air discharges were applied only to non-conductive surfaces of the EUT.

During the test, it was performed with single discharges. For the single discharge time between successive single discharges will be keep longer 1 second. It was at least ten single discharges with positive and negative at the same selected point.

The selected point, which was performed with electrostatic discharge, was marked on the red label of the EUT.

Indirect application of discharges to the EUT:

Vertical Coupling Plane (VCP):

The coupling plane, of dimensions 0.5m x 0.5m, is placed parallel to, and positioned at a distance 0.1m from, the EUT, with the Discharge Electrode touching the coupling plane.

The four faces of the EUT will be performed with electrostatic discharge. It was at least ten single discharges with positive and negative at the same selected point.

Horizontal Coupling Plane (HCP):

The coupling plane is placed under to the EUT. The generator shall be positioned vertically at a distance of 0.1m from the EUT, with the Discharge Electrode touching the coupling plane.

The four faces of the EUT will be performed with electrostatic discharge. It was at least ten single discharges with positive and negative at the same selected point.

## 8.5. Deviation from Test Standard

No deviation.

**8.6. Test Result**

Product	Network Camera		
Test Item	Electrostatic Discharge		
Test Mode	Mode 1: Normal Operation (Adapter)		
Date of Test	2009/10/05	Test Site	No.3 Shielded Room

Item	Amount of Discharge	Voltage	Required Criteria	Complied To Criteria (A,B,C)	Results
Air Discharge	10	+8kV	B	A	Pass
	10	-8kV	B	A	Pass
Contact Discharge	25	+4kV	B	A	Pass
	25	-4kV	B	A	Pass
Indirect Discharge (HCP)	25	+4kV	B	A	Pass
	25	-4kV	B	A	Pass
Indirect Discharge (VCP Front)	25	+4kV	B	A	Pass
	25	-4kV	B	A	Pass
Indirect Discharge (VCP Left)	25	+4kV	B	A	Pass
	25	-4kV	B	A	Pass
Indirect Discharge (VCP Back)	25	+4kV	B	A	Pass
	25	-4kV	B	A	Pass
Indirect Discharge (VCP Right)	25	+4kV	B	A	Pass
	25	-4kV	B	A	Pass

Note:

The testing performed is from lowest level up to the highest level as required by standard, but only highest level is shown on the report.

NR: No Requirement

- Meet criteria A: Operate as intended during and after the test
- Meet criteria B: Operate as intended after the test
- Meet criteria C: Loss/Error of function
- Additional Information
  - EUT stopped operation and could / could not be reset by operator at \_\_\_\_ kV.
  - No false alarms or other malfunctions were observed during or after the test.

Remark:

The Contact discharges were applied at least total 200 discharges at a minimum of four test points.

Product	Network Camera		
Test Item	Electrostatic Discharge		
Test Mode	Mode 2: Normal Operation (PoE)		
Date of Test	2009/10/05	Test Site	No.3 Shielded Room

Item	Amount of Discharge	Voltage	Required Criteria	Complied To Criteria (A,B,C)	Results
Air Discharge	10	+8kV	B	A	Pass
	10	-8kV	B	A	Pass
Contact Discharge	25	+4kV	B	A	Pass
	25	-4kV	B	A	Pass
Indirect Discharge (HCP)	25	+4kV	B	A	Pass
	25	-4kV	B	A	Pass
Indirect Discharge (VCP Front)	25	+4kV	B	A	Pass
	25	-4kV	B	A	Pass
Indirect Discharge (VCP Left)	25	+4kV	B	A	Pass
	25	-4kV	B	A	Pass
Indirect Discharge (VCP Back)	25	+4kV	B	A	Pass
	25	-4kV	B	A	Pass
Indirect Discharge (VCP Right)	25	+4kV	B	A	Pass
	25	-4kV	B	A	Pass

**Note:**

The testing performed is from lowest level up to the highest level as required by standard, but only highest level is shown on the report.

NR: No Requirement

- Meet criteria A: Operate as intended during and after the test
- Meet criteria B: Operate as intended after the test
- Meet criteria C: Loss/Error of function
- Additional Information
  - EUT stopped operation and could / could not be reset by operator at \_\_\_\_ kV.
  - No false alarms or other malfunctions were observed during or after the test.

**Remark:**

The Contact discharges were applied at least total 200 discharges at a minimum of four test points.

## 8.7. Test Photograph

Test Mode : Mode 1: Normal Operation (Adapter)

Description : ESD Test Setup



Test Mode : Mode 2: Normal Operation (PoE)

Description : ESD Test Setup



## 9. Radiated Susceptibility

### 9.1. Test Specification

According to Standard : IEC 61000-4-3

### 9.2. Test Setup

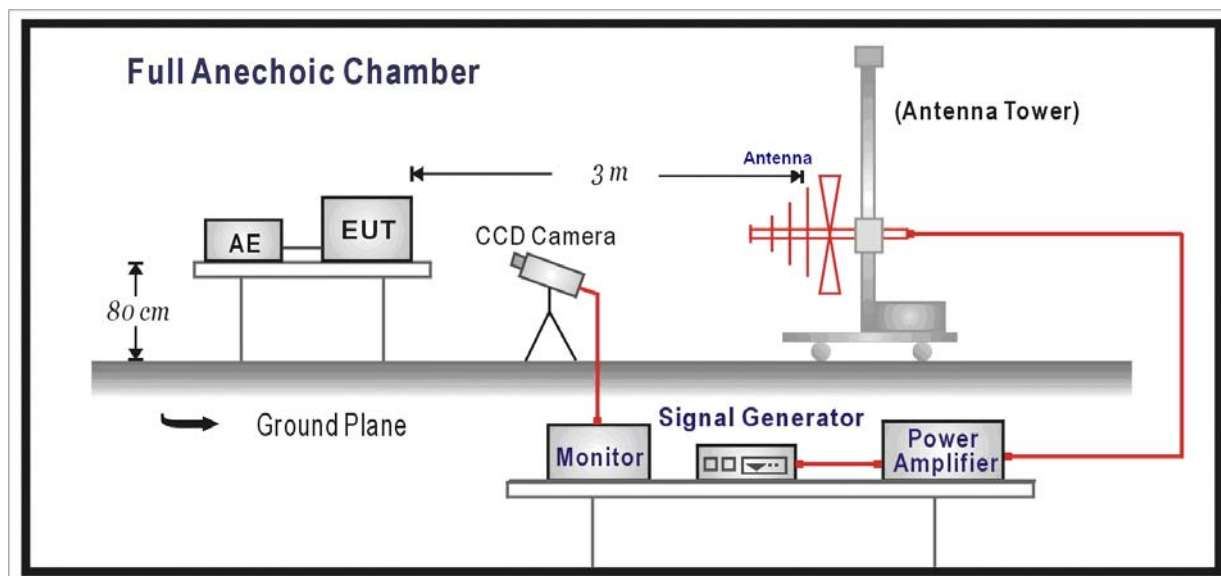

### 9.3. Limit

Item	Environmental Phenomena	Units	Test Specification	Performance Criteria
Enclosure Port				
	Radio-Frequency	MHz	80-1000	A
	Electromagnetic Field	V/m(Un-modulated, rms)	3	
	Amplitude Modulated	% AM (1kHz)	80	

#### 9.4. Test Procedure

The EUT and load, which are placed on a table that is 0.8 meter above ground, are placed with one coincident with the calibration plane such that the distance from antenna to the EUT was 3 meters.

Both horizontal and vertical polarization of the antenna and four sides of the EUT are set on measurement.

In order to judge the EUT performance, a CCD camera is used to monitor EUT screen.

All the scanning conditions are as follows:

Condition of Test	Remarks
1. Field Strength	3 V/m Level 2
2. Radiated Signal	AM 80% Modulated with 1kHz
3. Scanning Frequency	80MHz - 1000MHz
4. Dwell Time	3 Seconds
5. Frequency step size $\Delta f$ :	1%
6. The rate of Swept of Frequency	$1.5 \times 10^{-3}$ decades/s

#### 9.5. Deviation from Test Standard

No deviation.



**9.6. Test Result**

Product	Network Camera		
Test Item	Radiated susceptibility		
Test Mode	Mode 1: Normal Operation (Adapter)		
Date of Test	2009/10/05	Test Site	Chamber5

Frequency (MHz)	Position (Angle)	Polarity (H or V)	Field Strength (V/m)	Required Criteria	Complied To Criteria (A, B, C)	Results
80-1000	FRONT	H	3	A	A	PASS
80-1000	FRONT	V	3	A	A	PASS
80-1000	BACK	H	3	A	A	PASS
80-1000	BACK	V	3	A	A	PASS
80-1000	RIGHT	H	3	A	A	PASS
80-1000	RIGHT	V	3	A	A	PASS
80-1000	LEFT	H	3	A	A	PASS
80-1000	LEFT	V	3	A	A	PASS
80-1000	UP	H	3	A	A	PASS
80-1000	UP	V	3	A	A	PASS
80-1000	DOWN	H	3	A	A	PASS
80-1000	DOWN	V	3	A	A	PASS

**Note:**

The testing performed is from lowest level up to the highest level as required by standard, but only highest level is shown on the report.

- Meet criteria A: Operate as intended during and after the test
- Meet criteria B: Operate as intended after the test
- Meet criteria C: Loss/Error of function
- Additional Information
  - There was no observable degradation in performance.
  - EUT stopped operation and could / could not be reset by operator at \_\_\_\_\_ V/m at frequency \_\_\_\_\_ MHz.
- No false alarms or other malfunctions were observed during or after the test.

Product	Network Camera		
Test Item	Radiated susceptibility		
Test Mode	Mode 2: Normal Operation (PoE)		
Date of Test	2009/10/05	Test Site	Chamber5

Frequency (MHz)	Position (Angle)	Polarity (H or V)	Field Strength (V/m)	Required Criteria	Complied To Criteria (A, B, C)	Results
80-1000	FRONT	H	3	A	A	PASS
80-1000	FRONT	V	3	A	A	PASS
80-1000	BACK	H	3	A	A	PASS
80-1000	BACK	V	3	A	A	PASS
80-1000	RIGHT	H	3	A	A	PASS
80-1000	RIGHT	V	3	A	A	PASS
80-1000	LEFT	H	3	A	A	PASS
80-1000	LEFT	V	3	A	A	PASS
80-1000	UP	H	3	A	A	PASS
80-1000	UP	V	3	A	A	PASS
80-1000	DOWN	H	3	A	A	PASS
80-1000	DOWN	V	3	A	A	PASS

**Note:**

The testing performed is from lowest level up to the highest level as required by standard, but only highest level is shown on the report.

- Meet criteria A: Operate as intended during and after the test
- Meet criteria B: Operate as intended after the test
- Meet criteria C: Loss/Error of function
- Additional Information
  - There was no observable degradation in performance.
  - EUT stopped operation and could / could not be reset by operator at \_\_\_\_\_ V/m at frequency \_\_\_\_\_ MHz.
- No false alarms or other malfunctions were observed during or after the test.

## 9.7. Test Photograph

Test Mode : Mode 1: Normal Operation (Adapter)

Description : Radiated Susceptibility Test Setup



Test Mode : Mode 2: Normal Operation (PoE)

Description : Radiated Susceptibility Test Setup



10. Electrical Fast Transient/Burst

10.1. Test Specification

According to Standard : IEC 61000-4-4

10.2. Test Setup

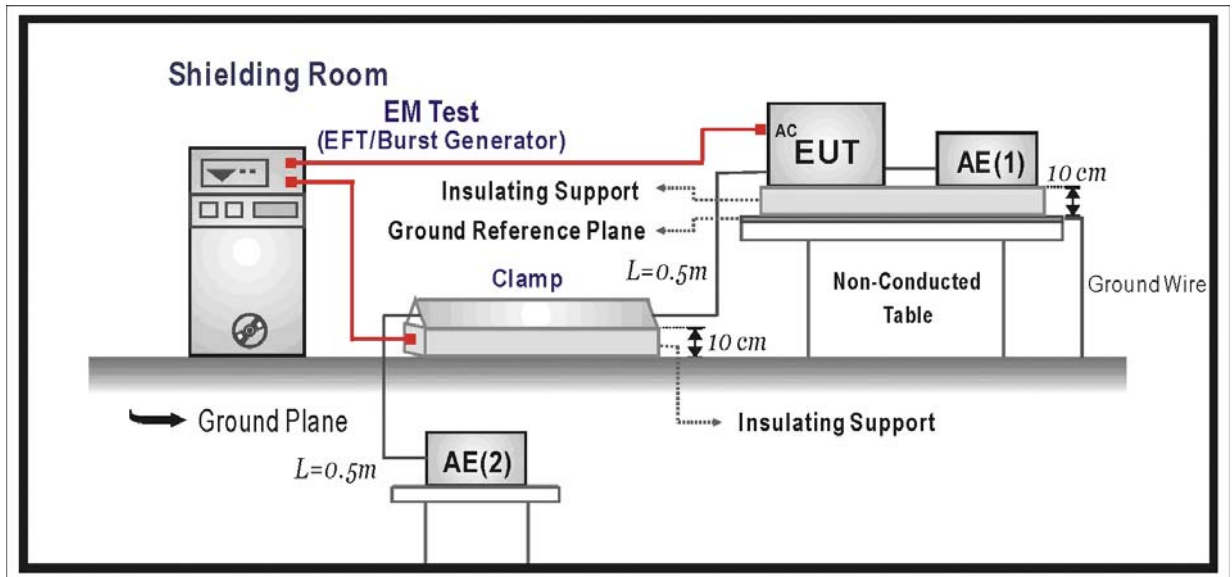

10.3. Limit

Item	Environmental Phenomena	Units	Test Specification	Performance Criteria
I/O and communication ports				
	Fast Transients Common Mode	kV (Peak) Tr/Th ns Rep. Frequency kHz	+0.5 5/50 5	B
Input DC Power Ports				
	Fast Transients Common Mode	kV (Peak) Tr/Th ns Rep. Frequency kHz	+0.5 5/50 5	B
Input AC Power Ports				
	Fast Transients Common Mode	kV (Peak) Tr/Th ns Rep. Frequency kHz	+1 5/50 5	B

#### **10.4. Test Procedure**

The EUT is placed on a table that is 0.8 meter height. A ground reference plane is placed on the table, and uses a 0.1m insulation between the EUT and ground reference plane.

The minimum area of the ground reference plane is 1m\*1m, and 0.65mm thick min, and projected beyond the EUT by at least 0.1m on all sides.

Test on I/O and communication ports:

The EFT interference signal is through a coupling clamp device couples to the signal and control lines of the EUT with burst noise for 1 minute.

Test on power supply ports:

The EUT is connected to the power mains through a coupling device that directly couples the EFT/B interference signal.

Each of the Line and Neutral conductors is impressed with burst noise for 1 minute.

The length of the signal and power lines between the coupling device and the EUT is 0.5m.

#### **10.5. Deviation from Test Standard**

No deviation.

**10.6. Test Result**

Product	Network Camera		
Test Item	Electrical fast transient/burst		
Test Mode	Mode 1: Normal Operation (Adapter)		
Date of Test	2009/09/29	Test Site	No.6 Shielded Room

Inject Line	Polarity	Voltage kV	Inject Time (Second)	Inject Method	Required Criteria	Complied to Criteria	Result
L+N	±	1kV	60	Direct	B	A	PASS

**Note:**

The testing performed is from lowest level up to the highest level as required by standard, but only highest level is shown on the report.

- Meet criteria A : Operate as intended during and after the test
- Meet criteria B : Operate as intended after the test
- Meet criteria C : Loss/Error of function
- Additional Information
  - EUT stopped operation and could / could not be reset by operator at \_\_\_\_\_ kV of Line \_\_\_\_\_.
- No false alarms or other malfunctions were observed during or after the test.

Product	Network Camera		
Test Item	Electrical fast transient/burst		
Test Mode	Mode 2: Normal Operation (PoE)		
Date of Test	2009/09/29	Test Site	No.6 Shielded Room

Inject Line	Polarity	Voltage kV	Inject Time (Second)	Inject Method	Required Criteria	Complied to Criteria	Result
LAN	±	0.5kV	60	Clamp	B	A	PASS

**Note:**

The testing performed is from lowest level up to the highest level as required by standard, but only highest level is shown on the report.

- Meet criteria A : Operate as intended during and after the test
- Meet criteria B : Operate as intended after the test
- Meet criteria C : Loss/Error of function
- Additional Information
  - EUT stopped operation and could / could not be reset by operator at \_\_\_\_\_ kV of Line \_\_\_\_\_.
- No false alarms or other malfunctions were observed during or after the test.

**10.7. Test Photograph**

Test Mode : Mode 1: Normal Operation (Adapter)

Description : EFT/B Test Setup



Test Mode : Mode 2: Normal Operation (PoE)

Description : EFT/B Test Setup-Clamp





11. Surge

11.1. Test Specification

According to Standard : IEC 61000-4-5

11.2. Test Setup

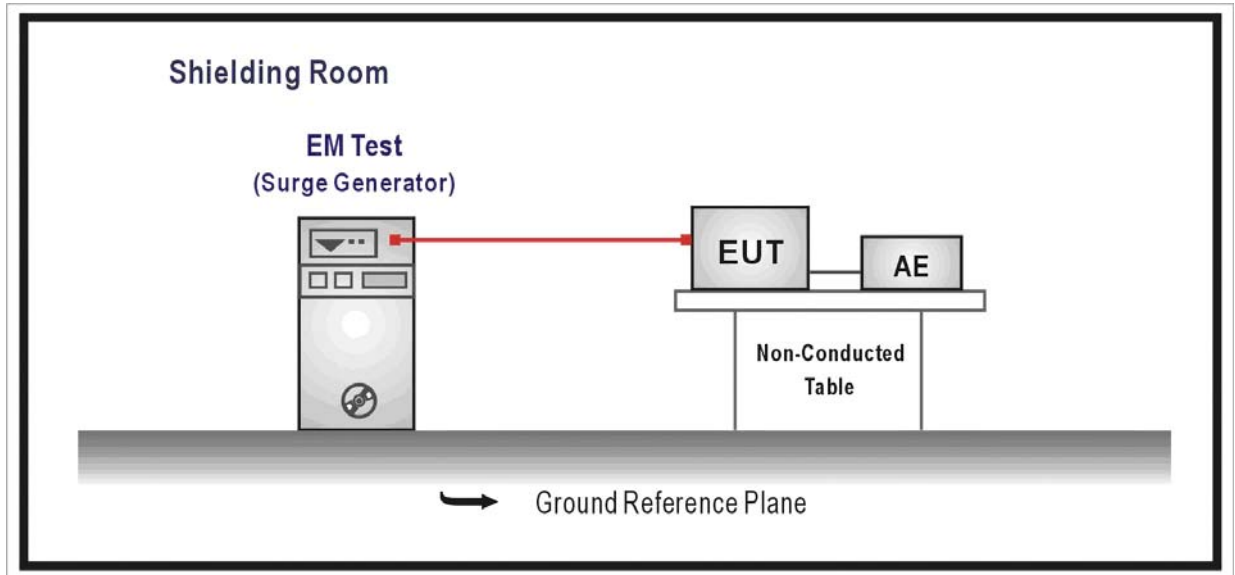

11.3. Limit

Item	Environmental Phenomena	Units	Test Specification	Performance Criteria
Signal Ports and Telecommunication Ports(See 1) and 2) )				
	Surges Line to Ground	Tr/Th us kV	1.2/50 (8/20) ± 1	B
Input DC Power Ports				
	Surges Line to Ground	Tr/Th us kV	1.2/50 (8/20) ± 0.5	B
AC Input and AC Output Power Ports				
	Surges Line to Line Line to Ground	Tr/Th us kV kV	1.2/50 (8/20) ± 1 ± 2	B

Notes:

- 1) Applicable only to ports which according to the manufacturer’s may directly to outdoor cables.
- 2) Where normal functioning cannot be achieved because of the impact of the CDN on the EUT, no immunity test shall be required.

#### **11.4. Test Procedure**

The EUT and its load are placed on a table that is 0.8 meter above a metal ground plane measured 1m\*1m min. and 0.65mm thick min. And projected beyond the EUT by at least 0.1m on all sides. The length of power cord between the coupling device and the EUT shall be 2m or less.

For Input and Output AC Power or DC Input and DC Output Power Ports:

The EUT is connected to the power mains through a coupling device that directly couples the Surge interference signal.

The surge noise shall be applied synchronized to the voltage phase at  $0^{\circ}$ ,  $90^{\circ}$ ,  $180^{\circ}$ ,  $270^{\circ}$  and the peak value of the a.c. voltage wave. (Positive and negative)

Each of Line-Earth and Line-Line is impressed with a sequence of five surge voltages with interval of 1 min.

#### **11.5. Deviation from Test Standard**

No deviation.

## 11.6. Test Result

Product	Network Camera		
Test Item	Surge		
Test Mode	Mode 1: Normal Operation (Adapter)		
Date of Test	2009/09/29	Test Site	No.6 Shielded Room

Inject Line	Polarity	Angle	Voltage kV	Time Interval (Second)	Inject Method	Required Criteria	Complied to Criteria	Result
L-N	±	0	1kV	60	Direct	B	A	PASS
L-N	±	90	1kV	60	Direct	B	A	PASS
L-N	±	180	1kV	60	Direct	B	A	PASS
L-N	±	270	1kV	60	Direct	B	A	PASS
L-PE	±	0	2kV	60	Direct	B	A	PASS
L-PE	±	90	2kV	60	Direct	B	A	PASS
L-PE	±	180	2kV	60	Direct	B	A	PASS
L-PE	±	270	2kV	60	Direct	B	A	PASS
N-PE	±	0	2kV	60	Direct	B	A	PASS
N-PE	±	90	2kV	60	Direct	B	A	PASS
N-PE	±	180	2kV	60	Direct	B	A	PASS
N-PE	±	270	2kV	60	Direct	B	A	PASS

**Note:**

The testing performed is from lowest level up to the highest level as required by standard, but only highest level is shown on the report.

- Meet criteria A : Operate as intended during and after the test
- Meet criteria B : Operate as intended after the test
- Meet criteria C : Loss/Error of function
- Additional Information
  - EUT stopped operation and could / could not be reset by operator at \_\_\_\_\_ kV of Line \_\_\_\_\_.
- No false alarms or other malfunctions were observed during or after the test.

## 11.7. Test Photograph

Test Mode : Mode 1: Normal Operation (Adapter)

Description : SURGE Test Setup



## 12. Conducted Susceptibility

### 12.1. Test Specification

According to Standard : IEC 61000-4-6

### 12.2. Test Setup

#### CDN Test Mode

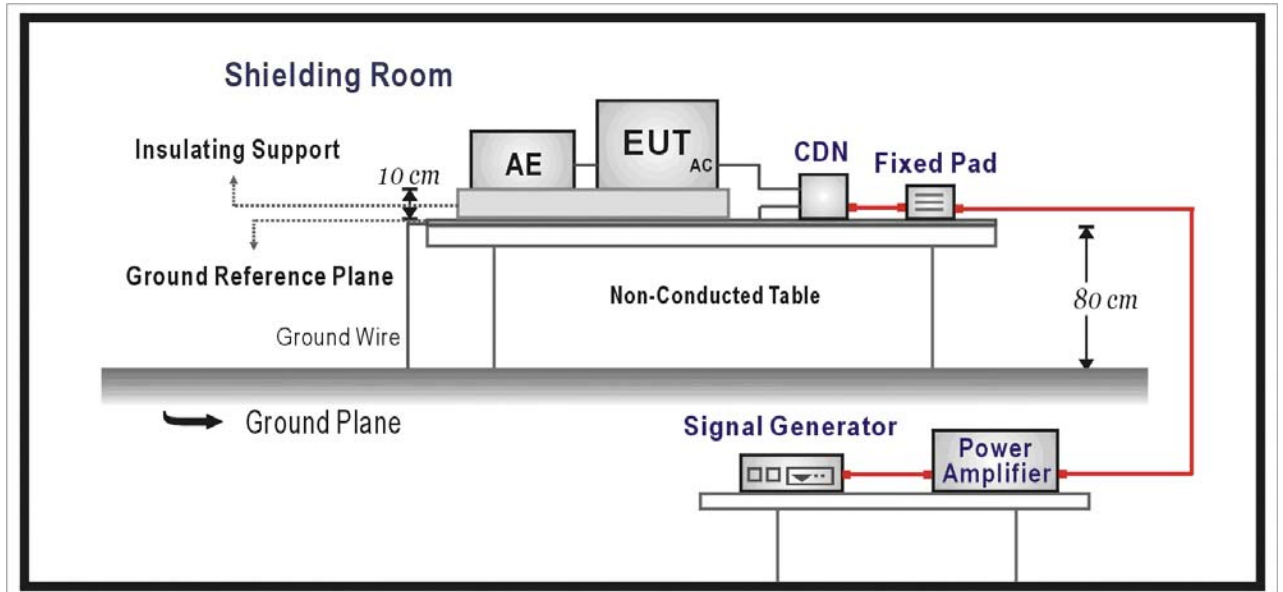

#### EM Clamp Test Mode

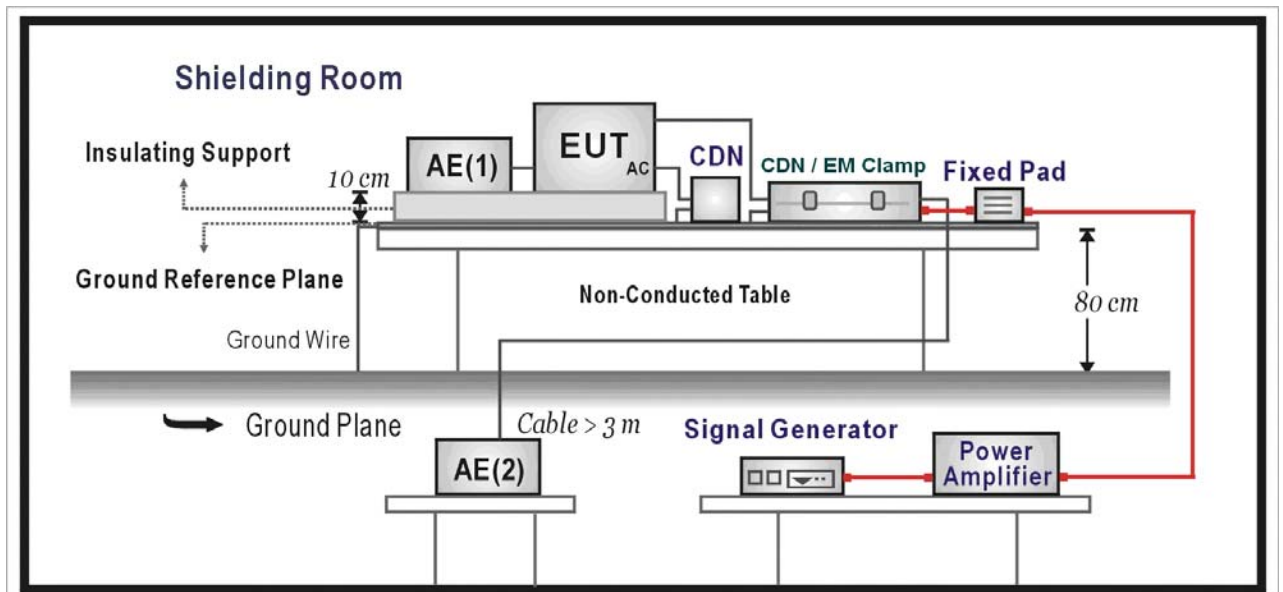

**12.3. Limit**

Item	Environmental Phenomena	Units	Test Specification	Performance Criteria
<b>Signal Ports and Telecommunication Ports</b>				
	Radio-Frequency Continuous Conducted	MHz V (rms, Un-modulated) % AM (1kHz)	0.15-80 3 80	A
<b>Input DC Power Ports</b>				
	Radio-Frequency Continuous Conducted	MHz V (rms, Un-modulated) % AM (1kHz)	0.15-80 3 80	A
<b>Input AC Power Ports</b>				
	Radio-Frequency Continuous Conducted	MHz V (rms, Un-modulated) % AM (1kHz)	0.15-80 3 80	A

**12.4. Test Procedure**

The EUT are placed on a table that is 0.8 meter height, and a Ground reference plane on the table, EUT are placed upon table and use a 10cm insulation between the EUT and Ground reference plane.

For Signal Ports and Telecommunication Ports

The disturbance signal is through a coupling and decoupling networks (CDN) or EM-clamp device couples to the signal and Telecommunication lines of the EUT.

For Input DC and AC Power Ports

The EUT is connected to the power mains through a coupling and decoupling networks for power supply lines. And directly couples the disturbances signal into EUT.

Used CDN-M2 for two wires or CDN-M3 for three wires.

All the scanning conditions are as follows:

Condition of Test	Remarks
1. Field Strength	130dBuV(3V) Level 2
2. Radiated Signal	AM 80% Modulated with 1kHz
3. Scanning Frequency	0.15MHz – 80MHz
4. Dwell Time	3 Seconds
5. Frequency step size $\Delta f$ :	1%
6. The rate of Swept of Frequency	$1.5 \times 10^{-3}$ decades/s

**12.5. Deviation from Test Standard**

No deviation.

**12.6. Test Result**

Product	Network Camera		
Test Item	Conducted susceptibility		
Test Mode	Mode 1: Normal Operation (Adapter)		
Date of Test	2009/09/29	Test Site	No.6 Shielded Room

Frequency Range (MHz)	Voltage Applied dBuV(V)	Inject Method	Tested Port of EUT	Required Criteria	Performance Criteria Complied To	Result
0.15~80	130 (3V)	CDN	AC IN	A	A	PASS
0.15~80	130 (3V)	CDN	LAN	A	A	PASS

Note:

The testing performed is from lowest level up to the highest level as required by standard, but only highest level is shown on the report.

- Meet criteria A : Operate as intended during and after the test
- Meet criteria B : Operate as intended after the test
- Meet criteria C : Loss/Error of function
- Additional Information
  - EUT stopped operation and could / could not be reset by operator at \_\_\_\_\_ dBuV(V) at frequency \_\_\_\_\_MHz.
  - No false alarms or other malfunctions were observed during or after the test. The acceptance criteria were met, and the EUT passed the test.

Product	Network Camera		
Test Item	Conducted susceptibility		
Test Mode	Mode 2: Normal Operation (PoE)		
Date of Test	2009/09/29	Test Site	No.6 Shielded Room

Frequency Range (MHz)	Voltage Applied dBuV(V)	Inject Method	Tested Port of EUT	Required Criteria	Performance Criteria Complied To	Result
0.15~80	130 (3V)	CDN	AC IN	A	A	PASS
0.15~80	130 (3V)	CDN	LAN	A	A	PASS

Note:

The testing performed is from lowest level up to the highest level as required by standard, but only highest level is shown on the report.

- Meet criteria A : Operate as intended during and after the test
- Meet criteria B : Operate as intended after the test
- Meet criteria C : Loss/Error of function
- Additional Information
  - EUT stopped operation and could / could not be reset by operator at \_\_\_\_\_ dBuV(V) at frequency \_\_\_\_\_MHz.
  - No false alarms or other malfunctions were observed during or after the test. The acceptance criteria were met, and the EUT passed the test.



## 12.7. Test Photograph

Test Mode : Mode 1: Normal Operation (Adapter)

Description : Conducted Susceptibility Test Setup



Test Mode : Mode 1: Normal Operation (Adapter)

Description : Conducted Susceptibility Test Setup-CDN



Test Mode : Mode 2: Normal Operation (PoE)

Description : Conducted Susceptibility Test Setup



**13. Power Frequency Magnetic Field**

**13.1. Test Specification**

According to Standard : IEC 61000-4-8

**13.2. Test Setup**

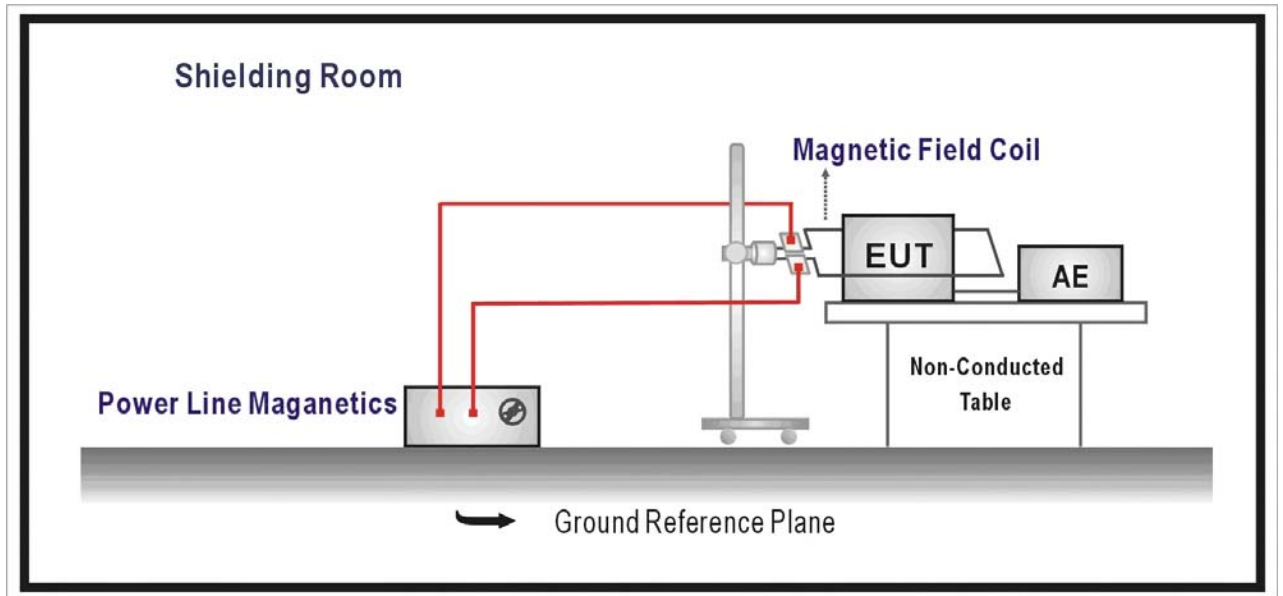

**13.3. Limit**

Item	Environmental Phenomena	Units	Test Specification	Performance Criteria
Enclosure Port				
	Power-Frequency Magnetic Field	Hz A/m (r.m.s.)	50 1	A

**13.4. Test Procedure**

The EUT and its load are placed on a table which is 0.8 meter above a metal ground plane measured at least 1m\*1m min. The test magnetic field shall be placed at central of the induction coil.

The test magnetic Field shall be applied 10 minutes by the immersion method to the EUT. And the induction coil shall be rotated by 90° in order to expose the EUT to the test field with different orientation (X, Y, Z Orientations).

**13.5. Deviation from Test Standard**

No deviation.

**13.6. Test Result**

Product	Network Camera		
Test Item	Power frequency magnetic field		
Test Mode	Mode 1: Normal Operation (Adapter)		
Date of Test	2009/09/29	Test Site	No.3 Shielded Room

Polarization	Frequency (Hz)	Magnetic Strength (A/m)	Required Performance Criteria	Performance Criteria Complied To	Test Result
X Orientation	50	1	A	A	PASS
Y Orientation	50	1	A	A	PASS
Z Orientation	50	1	A	A	PASS

- Meet criteria A: Operate as intended during and after the test
- Meet criteria B: Operate as intended after the test
- Meet criteria C: Loss/Error of function
- Additional Information
  - EUT stopped operation and could / could not be reset by operator at \_\_\_\_\_ kV of Line \_\_\_\_\_.
- No false alarms or other malfunctions were observed during or after the test. The acceptance criteria were met, and the EUT passed the test.

Product	Network Camera		
Test Item	Power frequency magnetic field		
Test Mode	Mode 2: Normal Operation (PoE)		
Date of Test	2009/09/29	Test Site	No.3 Shielded Room

Polarization	Frequency (Hz)	Magnetic Strength (A/m)	Required Performance Criteria	Performance Criteria Complied To	Test Result
X Orientation	50	1	A	A	PASS
Y Orientation	50	1	A	A	PASS
Z Orientation	50	1	A	A	PASS

- Meet criteria A: Operate as intended during and after the test
- Meet criteria B: Operate as intended after the test
- Meet criteria C: Loss/Error of function
- Additional Information
  - EUT stopped operation and could / could not be reset by operator at \_\_\_\_\_ kV of Line \_\_\_\_\_.
- No false alarms or other malfunctions were observed during or after the test. The acceptance criteria were met, and the EUT passed the test.

## 13.7. Test Photograph

Test Mode : Mode 1: Normal Operation (Adapter)

Description : Power Frequency Magnetic Field Test Setup



Test Mode : Mode 2: Normal Operation (PoE)

Description : Power Frequency Magnetic Field Test Setup



## 14. Voltage Dips and Interruption

### 14.1. Test Specification

According to Standard : IEC 61000-4-11

### 14.2. Test Setup

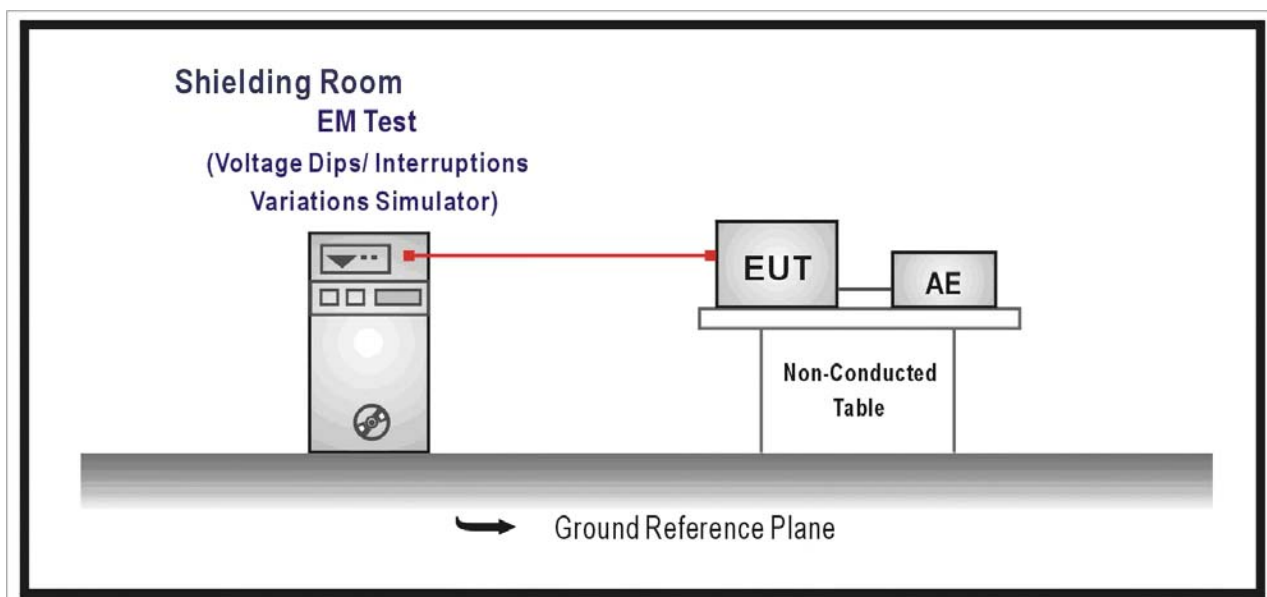

### 14.3. Limit

Item	Environmental Phenomena	Units	Test Specification	Performance Criteria
Input AC Power Ports				
Voltage Dips		% Reduction	30	C
		Period	25	
Voltage Interruptions		% Reduction	>95	B
		Period	0.5	
Voltage Interruptions		% Reduction	> 95	C
		Period	250	

#### 14.4. Test Procedure

The EUT and its load are placed on a table which is 0.8 meter above a metal ground plane measured 1m\*1m min. And 0.65mm thick min. And projected beyond the EUT by at least 0.1m on all sides. The power cord shall be used the shortest power cord as specified by the manufacturer.

For Voltage Dips/ Interruptions test:

The selection of test voltage is based on the rated power range. If the operation range is large than 20% of lower power range, both end of specified voltage shall be tested.

Otherwise, the typical voltage specification is selected as test voltage.

The EUT is connected to the power mains through a coupling device that directly couples to the Voltage Dips and Interruption Generator.

The EUT shall be tested for 30% voltage dip of supplied voltage and duration 25 Periods, for 95% voltage dip of supplied voltage and duration 0.5 Periods with a sequence of three voltage dips with intervals of 10 seconds, and for 95% voltage interruption of supplied voltage and duration 250 Periods with a sequence of three voltage interruptions with intervals of 10 seconds.

Voltage phase shifting are shall occur at  $0^{\circ}$ ,  $45^{\circ}$ ,  $90^{\circ}$ ,  $135^{\circ}$ ,  $180^{\circ}$ ,  $225^{\circ}$ ,  $270^{\circ}$ ,  $315^{\circ}$  of the voltage.

#### 14.5. Deviation from Test Standard

No deviation.



**14.6. Test Result**

Product	Network Camera		
Test Item	Voltage dips and interruption		
Test Mode	Mode 1: Normal Operation (Adapter)		
Date of Test	2009/09/29	Test Site	No.6 Shielded Room

Voltage Dips and Interruption Reduction(%)	Angle	Test Duration (Periods)	Required Performance Criteria	Performance Criteria Complied To	Test Result
30	0	25	C	A	PASS
30	45	25	C	A	PASS
30	90	25	C	A	PASS
30	135	25	C	A	PASS
30	180	25	C	A	PASS
30	225	25	C	A	PASS
30	270	25	C	A	PASS
30	315	25	C	A	PASS
>95	0	0.5	B	A	PASS
>95	45	0.5	B	A	PASS
>95	90	0.5	B	A	PASS
>95	135	0.5	B	A	PASS
>95	180	0.5	B	A	PASS
>95	225	0.5	B	A	PASS
>95	270	0.5	B	A	PASS
>95	315	0.5	B	A	PASS
>95	0	250	C	C	PASS
>95	45	250	C	C	PASS
>95	90	250	C	C	PASS
>95	135	250	C	C	PASS
>95	180	250	C	C	PASS
>95	225	250	C	C	PASS
>95	270	250	C	C	PASS
>95	315	250	C	C	PASS

- Meet criteria A: Operate as intended during and after the test
- Meet criteria B: Operate as intended after the test
- Meet criteria C: Loss/Error of function
- Additional Information
  - The nominal voltage of EUT is 230V.
  - EUT stopped operation and could / could not be reset by operator at \_\_\_\_\_ kV of Line \_\_\_\_\_.
- No false alarms or other malfunctions were observed during or after the test. The acceptance criteria were met, and the EUT passed the test.

## 14.7. Test Photograph

Test Mode : Mode 1: Normal Operation (Adapter)

Description : Voltage Dips Test Setup



15. Attachment

➤ EUT Photograph

(1) EUT Photo



(2) EUT Photo



(3) EUT Photo



(4) EUT Photo



(5) EUT Photo

