

DrayTek

VigorAP 960C

802.11ax Ceiling-mount AP



USER'S GUIDE

V1.1

VigorAP 960C

802.11ax Ceiling-mount AP

User's Guide

Version: 1.1

Firmware Version: V1.4.0

Date: April 22, 2021

Intellectual Property Rights (IPR) Information

Copyrights

© All rights reserved. This publication contains information that is protected by copyright. No part may be reproduced, transmitted, transcribed, stored in a retrieval system, or translated into any language without written permission from the copyright holders.

Trademarks

The following trademarks are used in this document:

- Microsoft is a registered trademark of Microsoft Corp.
- Windows 8, 10 and Explorer are trademarks of Microsoft Corp.
- Apple and Mac OS are registered trademarks of Apple Inc.
- Other products may be trademarks or registered trademarks of their respective manufacturers.

Safety Instructions and Approval

Safety Instructions

- Read the installation guide thoroughly before you set up the modem.
- The modem is a complicated electronic unit that may be repaired only be authorized and qualified personnel. Do not try to open or repair the modem yourself.
- Do not place the modem in a damp or humid place, e.g. a bathroom.
- The modem should be used in a sheltered area, within a temperature range of +5 to +40 Celsius.
- Do not expose the modem to direct sunlight or other heat sources. The housing and electronic components may be damaged by direct sunlight or heat sources.
- Do not deploy the cable for LAN connection outdoor to prevent electronic shock hazards.
- Keep the package out of reach of children.
- When you want to dispose of the modem, please follow local regulations on conservation of the environment.

Warranty

We warrant to the original end user (purchaser) that the modem will be free from any defects in workmanship or materials for a period of two (2) years from the date of purchase from the dealer. Please keep your purchase receipt in a safe place as it serves as proof of date of purchase. During the warranty period, and upon proof of purchase, should the product have indications of failure due to faulty workmanship and/or materials, we will, at our discretion, repair or replace the defective products or components, without charge for either parts or labor, to whatever extent we deem necessary to restore the product to proper operating condition. Any replacement will consist of a new or re-manufactured functionally equivalent product of equal value, and will be offered solely at our discretion. This warranty will not apply if the product is modified, misused, tampered with, damaged by an act of God, or subjected to abnormal working conditions. The warranty does not cover the bundled or licensed software of other vendors. Defects which do not significantly affect the usability of the product will not be covered by the warranty. We reserve the right to revise the manual and online documentation and to make changes from time to time in the contents hereof without obligation to notify any person of such revision or changes.

Be a Registered Owner

Web registration is preferred. You can register your Vigor router via <https://myvigor.draytek.com>.

Firmware & Tools Updates

Due to the continuous evolution of DrayTek technology, all modems will be regularly upgraded. Please consult the DrayTek web site for more information on newest firmware, tools and documents. <https://www.draytek.com>

Table of Contents

| | |
|----------------------------------------------------------------------|------------|
| Chapter I Installation | VII |
| I-1 Introduction | 1 |
| I-1-1 LED Indicators and Connectors | 3 |
| I-2 Hardware Installation | 4 |
| I-2-1 Ceiling-mount Installation (Wooden Ceiling) | 4 |
| I-2-2 Ceiling-mount Installation (Plasterboard Ceiling) | 5 |
| I-2-3 Suspended Ceiling (Lightweight Steel Frame) Installation | 6 |
| I-2-4 Wall-Mounted Installation | 8 |
| I-2-5 Notifications for Hardware Connection | 9 |
| I-2-6 Connect to a Vigor Router using AP Management | 10 |
| I-2-7 Connect to a Vigor Router without AP Management | 11 |
| I-2-8 Connect without a DrayTek Router/LAN | 12 |
| I-2-9 Connecting to PC Directly | 13 |
| I-3 Network IP Configuration | 14 |
| I-3-1 Windows 10 IP Address Setup | 14 |
| I-4 Accessing to Web User Interface | 17 |
| I-5 Changing Password | 20 |
| I-6 Dashboard | 21 |
| I-7 Quick Start Wizard | 22 |
| I-7-1 Settings for Access Point | 23 |
| I-7-2 Settings for Mesh Root | 26 |
| I-7-3 Settings for Mesh Node | 31 |
| I-7-4 Settings for Range Extender | 32 |
| Chapter II Connectivity | 37 |
| II-1 Operation Mode | 38 |
| II-2 General Concepts for Wireless LAN (2.4GHz/5GHz) | 40 |
| II-3 Wireless LAN (2.4GHz/5GHz) Settings for AP Mode | 43 |
| II-3-1 General Setup | 44 |
| II-3-2 Security | 46 |
| II-3-3 Access Control | 49 |
| II-3-4 WPS | 50 |
| II-3-5 Advanced Setting | 52 |
| II-3-6 AP Discovery | 54 |
| II-3-7 WDS AP Status | 55 |
| II-3-8 Airtime Fairness | 55 |
| II-3-9 Station Control | 58 |
| II-3-10 Roaming | 59 |
| II-3-11 Band Steering (for Wireless LAN (2.4GHz)) | 61 |
| II-3-12 Station List | 66 |
| II-4 Mesh Settings for Mesh Mode | 72 |
| II-4-1 Mesh Setup | 74 |
| II-4-2 Mesh Status | 79 |
| II-4-3 Mesh Discovery | 80 |
| II-4-4 Basic Configuration Sync | 81 |
| II-4-5 Advanced Config Sync | 84 |
| II-4-6 Support List | 85 |
| II-4-7 Mesh Syslog | 85 |
| II-5 Universal Repeater Settings for Range Extender Mode | 86 |
| II-6 LAN | 90 |

| | |
|----------------------------------------------------|------------|
| II-6-1 General Setup | 90 |
| II-6-2 Hotspot Web Portal..... | 93 |
| II-6-3 Port Control..... | 96 |
| Chapter III Management | 97 |
| III-1 System Maintenance..... | 98 |
| III-1-1 System Status | 99 |
| III-1-2 TR-069 | 100 |
| III-1-3 Administrator Password | 102 |
| III-1-4 User Password..... | 103 |
| III-1-5 Configuration Backup..... | 104 |
| III-1-6 Syslog/Mail Alert..... | 106 |
| III-1-7 Time and Date | 107 |
| III-1-8 SNMP..... | 108 |
| III-1-9 Management..... | 109 |
| III-1-10 Reboot System | 111 |
| III-1-11 Firmware Upgrade | 112 |
| III-2 Central AP Management..... | 113 |
| III-2-1 General Setup | 113 |
| III-2-2 APM Log..... | 114 |
| III-2-3 Overload Management | 115 |
| III-2-4 Status of Settings..... | 116 |
| III-3 Mobile Device Management | 117 |
| III-3-1 Station List..... | 117 |
| III-3-2 Station Statistics | 124 |
| III-3-3 Station Nearby..... | 125 |
| III-3-4 Policies | 126 |
| III-3-5 Station Control List | 127 |
| Chapter IV Others | 129 |
| IV-1 RADIUS Setting..... | 130 |
| IV-1-1 RADIUS Server | 130 |
| IV-1-2 Certificate Management | 131 |
| IV-2 Applications..... | 134 |
| IV-2-1 Schedule | 134 |
| IV-2-2 Wi-Fi Auto On/Off..... | 136 |
| IV-3 Objects Setting..... | 137 |
| IV-3-1 Device Object..... | 137 |
| IV-3-2 Device Group | 139 |
| Chapter V Mobile APP, DrayTek Wireless..... | 141 |
| V-1 Introduction of DrayTek Wireless..... | 142 |
| V-2 Select a VigorAP | 143 |
| V-3 Quick Start Wizard | 144 |
| V-4 Login | 153 |
| Chapter VI Troubleshooting..... | 157 |
| VI-1 Diagnostics | 158 |
| VI-1-1 System Log | 159 |
| VI-1-2 Speed Test..... | 159 |
| VI-1-3 Traffic Graph..... | 160 |
| VI-1-4 WLAN (2.4GHz) Statistics..... | 161 |
| VI-1-5 WLAN (5GHz) Statistics | 162 |
| VI-1-6 Interference Monitor | 163 |

| | |
|-----------------------------------------------------|-----|
| VI-1-7 Support..... | 163 |
| VI-2 Checking the Hardware Status | 164 |
| VI-3 Checking the Network Connection Settings | 165 |
| VI-3-1 For Windows | 165 |
| VI-3-2 For Mac Os | 167 |
| VI-4 Pinging the Device | 168 |
| VI-4-1 For Windows | 168 |
| VI-4-2 For Mac Os (Terminal) | 168 |
| VI-5 Backing to Factory Default Setting..... | 170 |
| VI-5-1 Software Reset..... | 170 |
| VI-5-2 Hardware Reset..... | 171 |
| VI-6 Contacting DrayTek | 172 |
| Index | 173 |

Chapter I Installation



I-1 Introduction

This is a generic International version of the user guide. Specification, compatibility and features vary by region. For specific user guides suitable for your region or product, please contact local distributor.

Thank you for purchasing this VigorAP 960C! With this high cost-efficiency VigorAP 960C, computers and wireless devices which are compatible with 802.11ax can connect to existing wired Ethernet network via this VigorAP 960C, at the speed of 300Mbps.

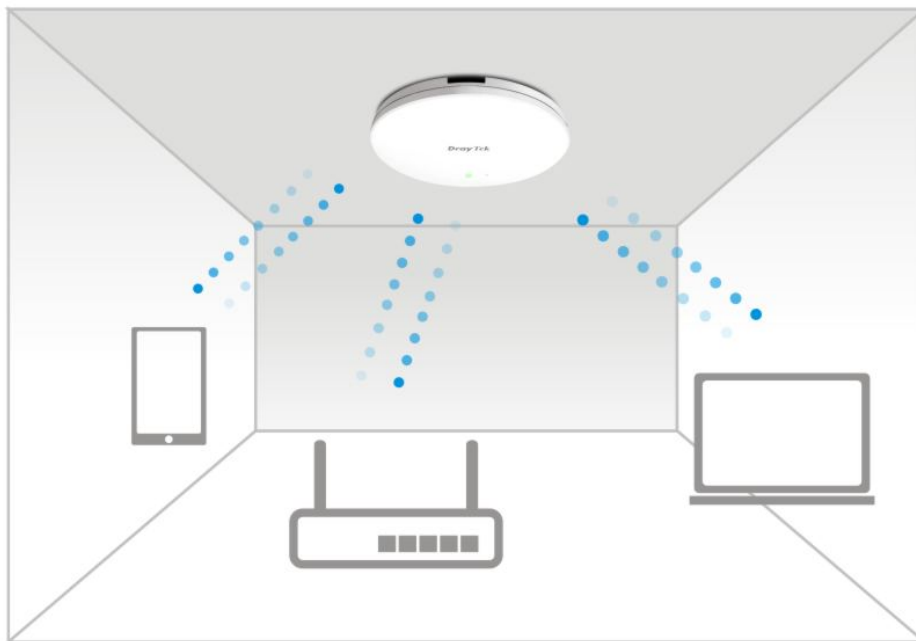

VigorAP 960C can operate in standalone mode for your office network or a classroom; connected to your LAN and offering you with wireless access.

It makes high density with quality-performance be feasible for users as it is going to be implemented with DrayTek central wireless management (AP Management) supports configuration, firmware upgrade, status, monitoring, and load-balancing.

The Power of Ethernet (PoE) on VigorAP 960C relieves the installation of power plug. The massive deployment of VigorAP 960C for hospitalities and school environment will be much easier.

With the optimized antennas built-in, DrayTek VigorAP 960C ceiling-mount wireless access point is ideal for hospitalities, small offices and small campus.

Easy install procedures allows any computer users to setup a network environment in very short time - within minutes, even inexperienced users. Just follow the instructions given in this user manual, you can complete the setup procedure and release the power of this access point all by yourself!



Support Mesh Network (

The message, information, and data can be transferred via wireless connection among VigorAP 960C devices without by using Ethernet cables. It can reduce the construction cost and eliminate the trouble of wiring. Therefore, mesh AP is suitable for outdoor activities, or meetings.

In short, VigorAP with mesh function has the following benefits:

- In the traditional wireless network, users must choose the best signal source manually from various SSIDs. The mesh AP can find out the best route automatically. Besides, if any one of the mesh AP devices disconnects due to unknown reason, the mesh system will determine another accessible AP and transfer the packets to that AP.
- Maintain a certain degree of normal operation for it is not easily affected by connection interference or terrain blocking of walls or floors.
- For the mesh network system adopts the mesh topology, each node in the network not only has a single connection but also interweaves to other nodes like a net. Because of such characteristics, the mesh network can set up stronger network architecture.
- Each node (mesh AP) in the mesh network can be operated as an independent wireless AP; therefore, the whole mesh network can offer a more stable and faster wireless connection.
- The mesh network is suitable for large spaces and large numbers of people for the configuration for each AP is easy and simple.

I-1-1 LED Indicators and Connectors

Before you use the Vigor modem, please get acquainted with the LED indicators and connectors first.

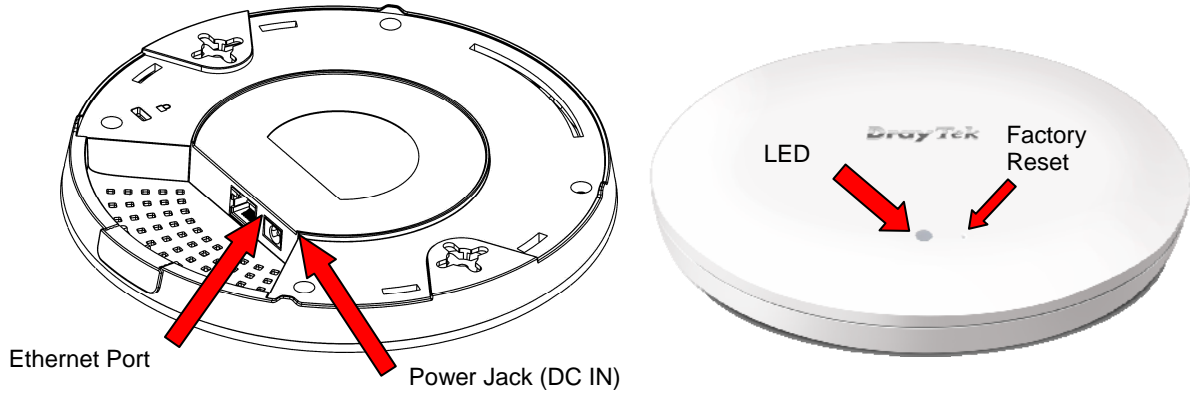

| LED | Status | Explanation |
|--------------------|--------------------------------------------------------------------------------------------------------------------------------------------------------------------------------------------------------------------------------------------------------------------------------------------------------------|-----------------------------------------------------------------------|
| Blue LED | On | The system is in boot-loader mode. |
| | Off | The system is not ready or fails. |
| | Blinking | The system is in AP mode and work normally. |
| Green LED | Blinking | The system is in Mesh mode or Range Extender mode and works normally. |
| Orange LED | Blinking | The system is in TFTP mode. |
| Off | Off | VigorAP is turned off or not functioning. |
| Interface | Explanation | |
| Ethernet Port | Connects to LAN or router. Supports PoE power & Gigabit (1000BaseT). | |
| Power Jack (DC IN) | Connector for a power adapter. | |
| Hole | Explanation | |
| Factory Reset | Restores the unit back to factory default settings. To use, insert a small item such as an unbent paperclip into the hole. You will feel the button inside depress gently. Hold it for 5 seconds. The VigorAP will restart with the factory default configuration and the LED will blink blue. | |

I-2 Hardware Installation

This section will guide you to install the VigorAP 960C through hardware connection and configure the device's settings through web browser.

Before starting to configure VigorAP 960C, you have to connect your devices correctly.

I-2-1 Ceiling-mount Installation (Wooden Ceiling)

1. Place the bracket under the wooden ceiling and fasten two screws firmly (as shown in Figure below, Step 1).
2. When the bracket is in place, fasten two screws firmly (as shown in Figure below, Step 2) on the bottom of VigorAP.
3. Make the device just below the bracket. Put the screws installed in Step 2 on the holes of the bracket (as shown in Figure below, Step 3).
4. Gently rotate the device to make screws slide into the notches of the bracket and move forward till it is firmly fixed.

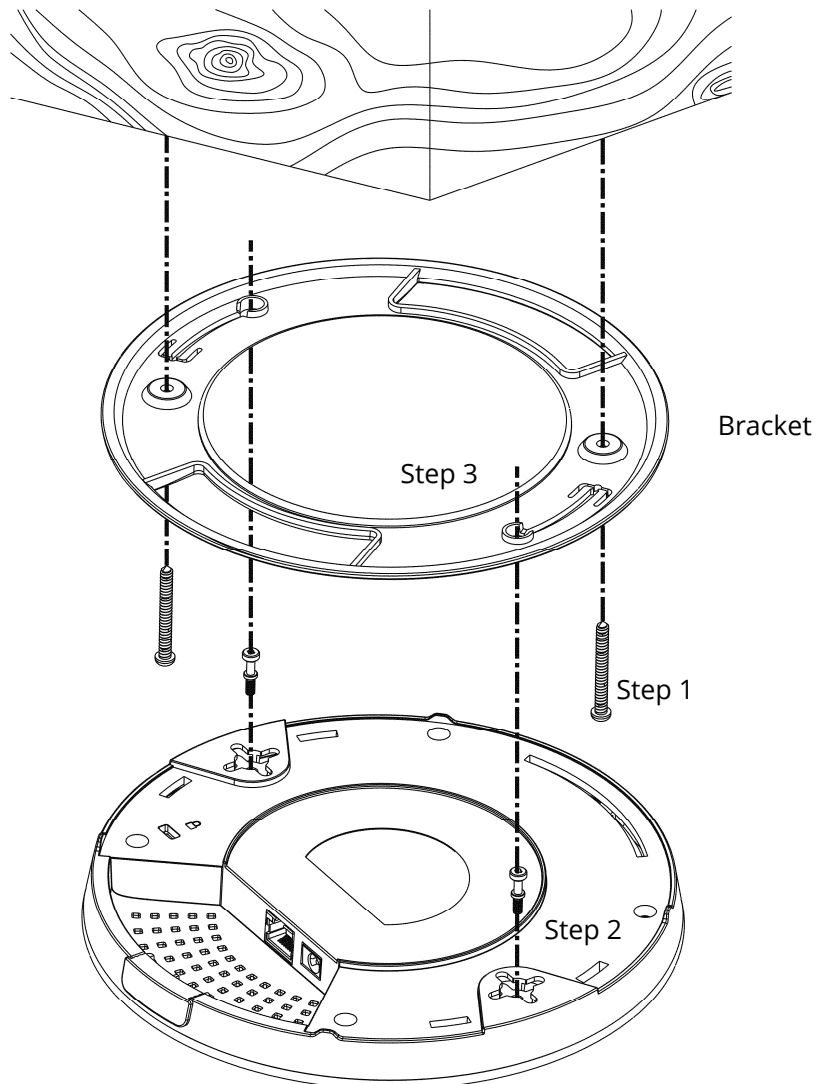

I-2-2 Ceiling-mount Installation (Plasterboard Ceiling)

1. Place the bracket under the plasterboard ceiling and fasten two turnbuckles firmly (as shown in Figure below, Step 1).
2. Make the screws pass through the bracket and insert into the turnbuckles (as shown in Figure below, Step 2). Fasten them to offer more powerful supporting force.
3. When the bracket is in place, fasten two screws firmly (as shown in Figure below, Step 3) on the bottom of VigorAP.
4. Make the device just below the bracket. Put the screws installed in Step 3 on the screw holes of the bracket (as shown in Figure below, Step 4).
5. Gently rotate the device to make screws slide into the notches of the bracket and move forward till it is firmly fixed.

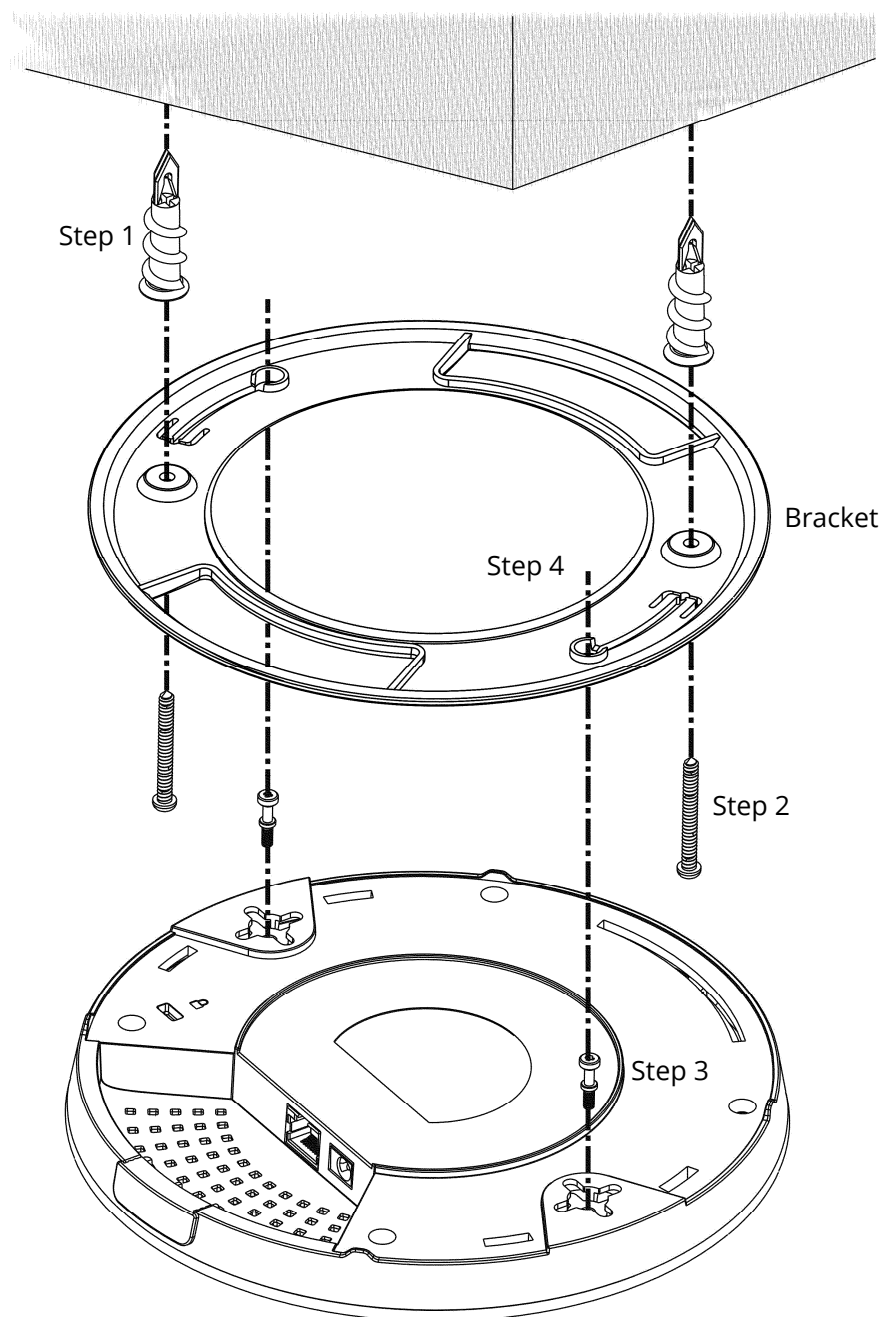

I-2-3 Suspended Ceiling (Lightweight Steel Frame) Installation

You cannot screw into ceiling tiles as they are weak and not suitable for bearing loads. Your VigorAP is supplied with mounts (T-Rail brackets) which attach directly to the metal grid ('T-Rail') of your suspended ceiling.

1. Choose one set of T-Rail mounting kits from the bundled package.
2. Put the T-Rail brackets on the holes of the bottom side of the device. Fasten them with suitable screws.

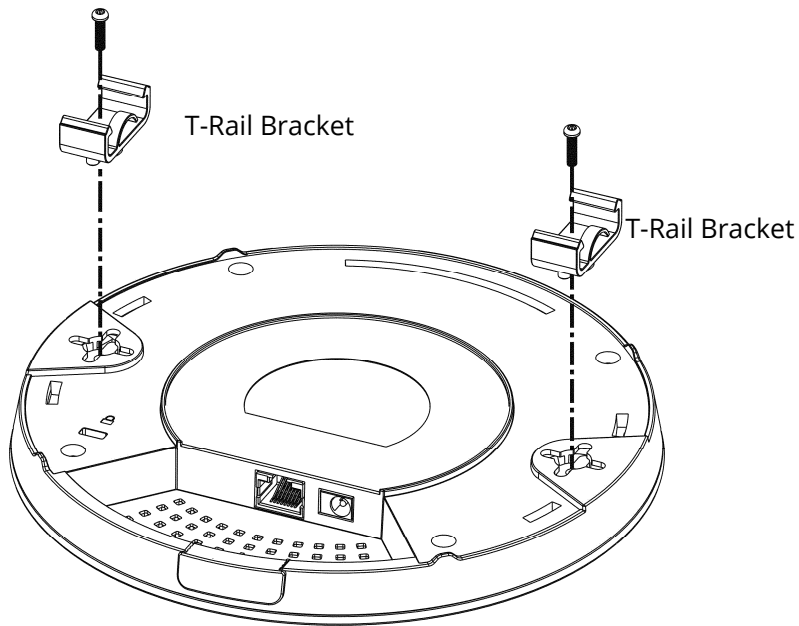

3. If a larger gap is required between the ceiling and the VigorAP, use the extension pieces to extend the height of the brackets.

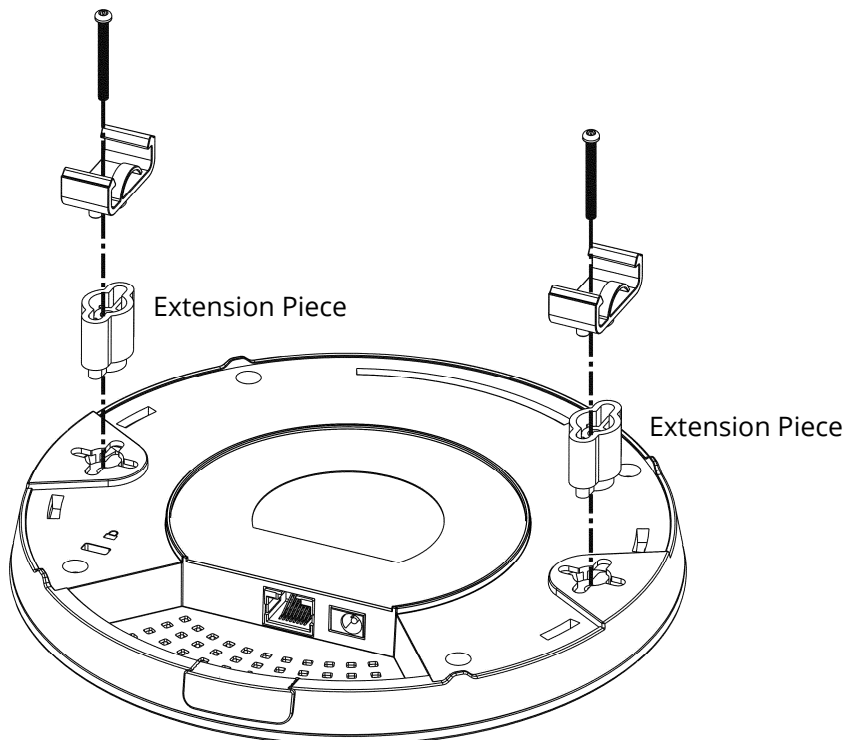

4. Use the T-Rail brackets to fasten the device on Light-weighted Steel Frame.

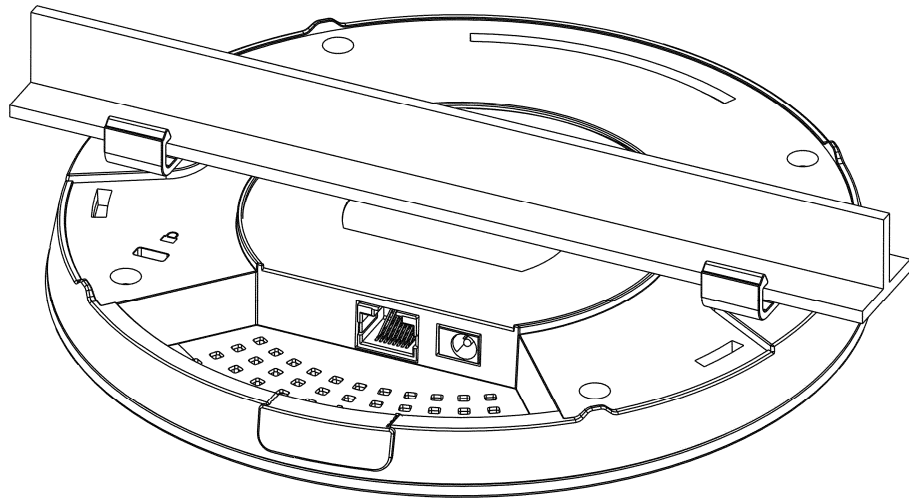

i Warning

The screw set shown below is for wall mounting only. Do not use such set for ceiling mounting due to the danger of falling.

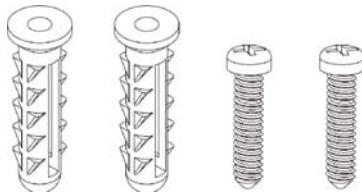

I-2-4 Wall-Mounted Installation

For wall-mounting, the VigorAP has keyhole type mounting slots on the underside. You can fit the AP at any axis (i.e. 12, 3, 6 or 9 O'Clock) to allow for cable entry from the most convenient location if you are using side entry – note the position of the side entry cable cutout.

1. A template is provided on the VigorAP's packaging box to enable you to space the screws correctly on the wall.



2. Place the template on the wall and drill the holes according to the recommended instruction.
3. Fit screws into the wall using the appropriate type of wall plug (as shown in the ceiling section) but do not use the ceiling bracket – the VigorAP hangs directly onto the screws.

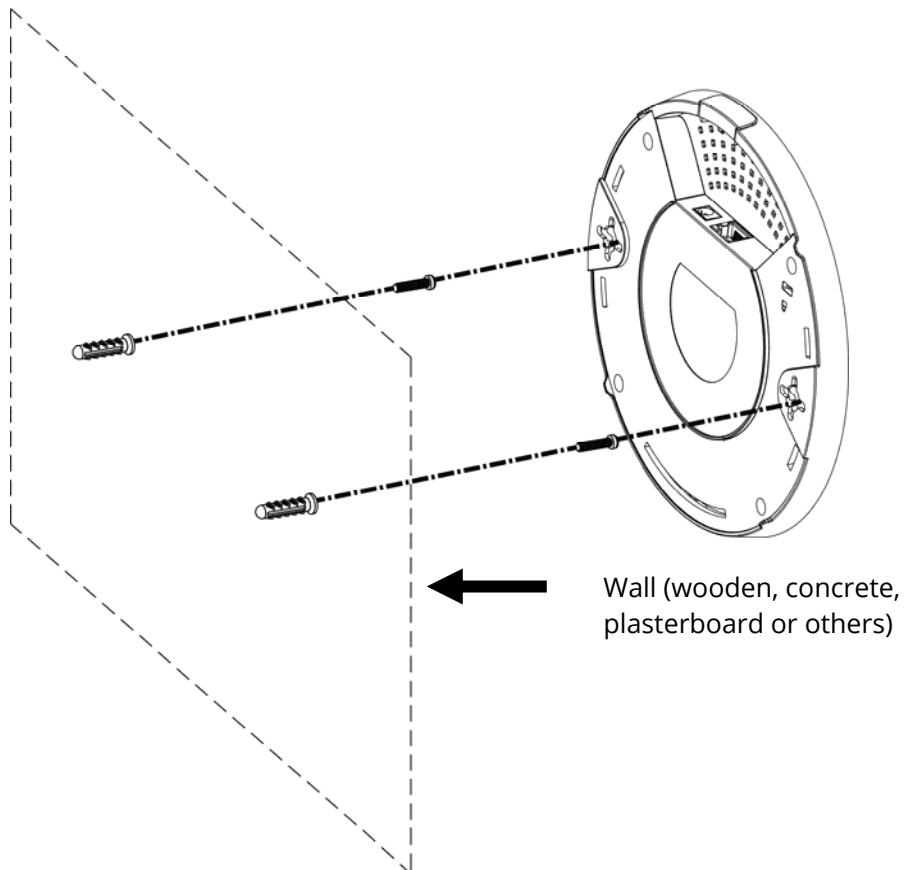

I-2-5 Notifications for Hardware Connection

- If required, remove the protective cap of VigorAP to create extra space for the cables to pass through.

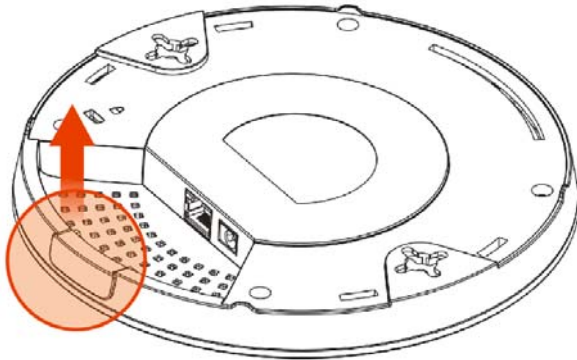

- Connect VigorAP to Vigor router (via LAN port) with Ethernet cable.

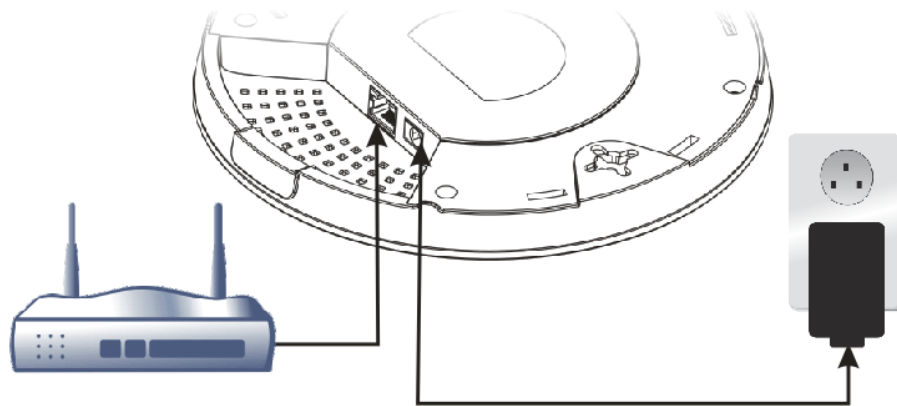

Vigor Router

- Connect VigorAP to PoE switch (via LAN port) with Ethernet cable. For connecting with PoE switch, do not connect the power adapter. VigorAP will get the power from the switch directly.

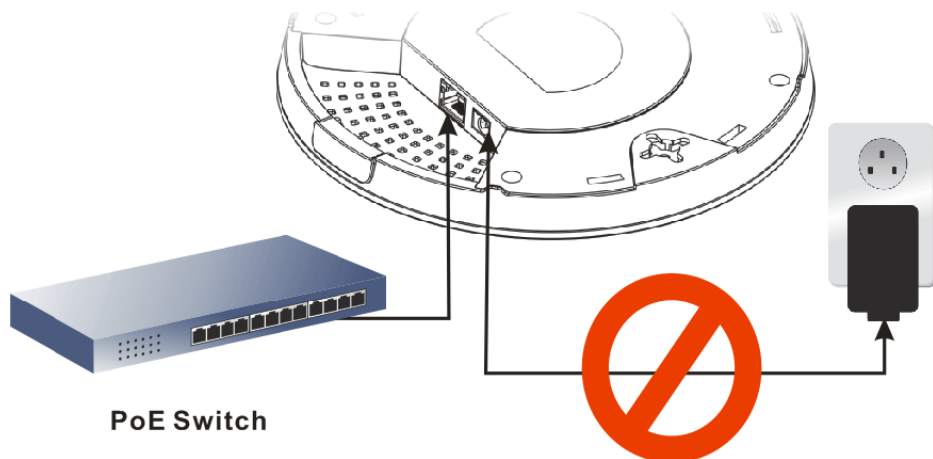

I-2-6 Connect to a Vigor Router using AP Management

Your VigorAP can be used with Vigor routers which support AP management (such as the Vigor 2865 or Vigor 2926 series). AP Management enables you to monitor and manage multiple DrayTek APs from a single interface.

1. Connect one end of the power adapter to power port of VigorAP, and the other side into a wall outlet.

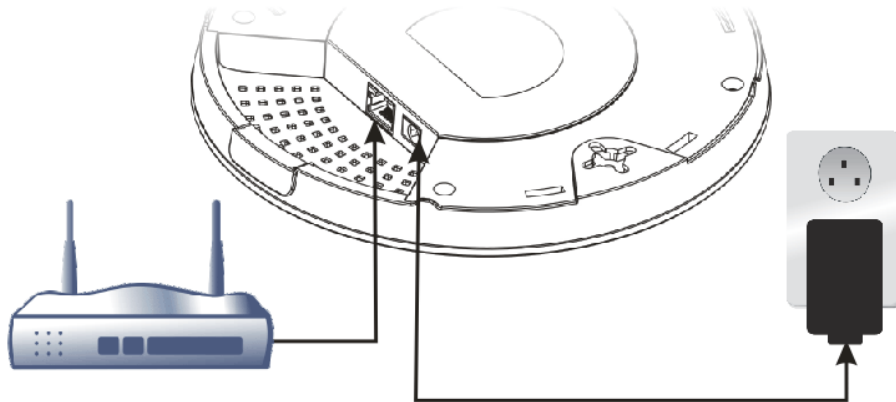

Vigor Router

2. Access into the web user interface of Vigor router. Here we take Vigor2862 as an example. Open **Central Management >> AP >> Status**.

Central Management >> AP >> Status

| Index | Device Name | IP Address | SSID | Ch. | STA List | AP List | Uptime | Ver. | Password |
|-------|-------------|--------------|----------------------|----------|--------------|---------|----------|-------|-------------------------------|
| 1 | VigorAP | 192.168.1.11 | DrayTek DrayTek5G | 11 36 | 0/64 0/64 | 0 0 | 0d 00:01 | 1.1.7 | Password <input type="text"/> |

Note:

 : Online  : Offline  : Hidden SSID

Maximum support 20 APs.

When AP Devices connect via an intermediary switch, please ensure that **UDP:4944** port and the **HTTP** port of AP Devices are not blocked so that the AP status can be retrieved.

3. Locate VigorAP 960C. Click the IP address assigned by Vigor router to access into web user interface of VigorAP 960C.
4. After entering username and password (admin/admin), the main screen will be displayed.

I-2-7 Connect to a Vigor Router without AP Management

1. Connect one end of the power adapter to power port of VigorAP, and the other side into a wall outlet.

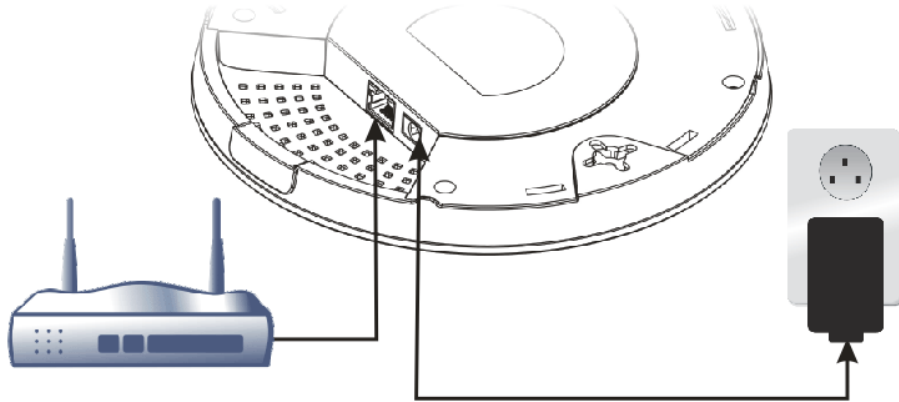

Vigor Router

2. Access into the web user interface of Vigor router. Here we take Vigor2865 as an example. Open **External Devices**.

External Devices

External Device Auto Discovery

External Devices Connected

Below shows available devices that connected externally:

For security reason:

If you have changed the administrator password on External Device, please click the **Account** button to retype new username and password. Otherwise, the router will be unable to monitor the External Device device properly. Click the **Clear** button to Clear the off-line information and account information.

OK

3. Check the box of **External Device Auto Discovery** and click **OK**. When the IP address assigned by Vigor router appears, click it to access into web user interface of VigorAP 960C.
4. After entering username and password (admin/admin), the main screen will be displayed.

I-2-8 Connect without a DrayTek Router/LAN

1. Connect one end of the power adapter to power port of VigorAP, and the other side into a wall outlet.

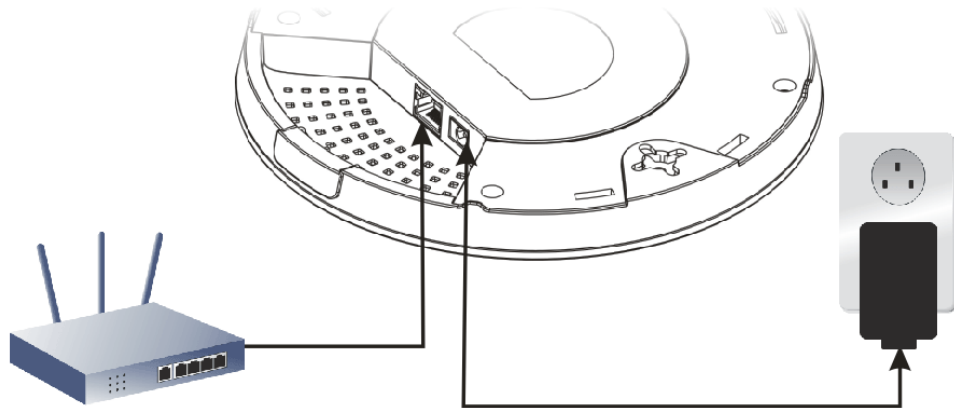

2. Access into the web user interface of the router.
3. Check that **DHCP table** to find an entry with a MAC address matching the VigorAP – the VigorAP's MAC address is printed on a label on the base. Once you have the VigorAP's IP address, you can access its own web interface, as shown in section II-6.

| LAN | |
|-------------|---------------------|
| MAC Address | : 00:1D:AA:74:DA:38 |
| IP Address | : 192.168.1.10 |
| IP Mask | : 255.255.255.0 |

4. After getting the IP address of VigorAP 960C, access into the web user interface of VigorAP 960C through the web page of non-Vigor router.

I-2-9 Connecting to PC Directly

1. Connect one end of an Ethernet cable (RJ-45) to one of the **LAN** ports of the VigorAP and the other end of the cable (RJ-45) into the Ethernet port on your computer.
2. Connect one end of the power adapter to VigorAP's power port on the bottom of the device, and the other side into a wall outlet.
3. Wait for VigorAP initiation. When VigorAP is ready, the LED will blink in blue.

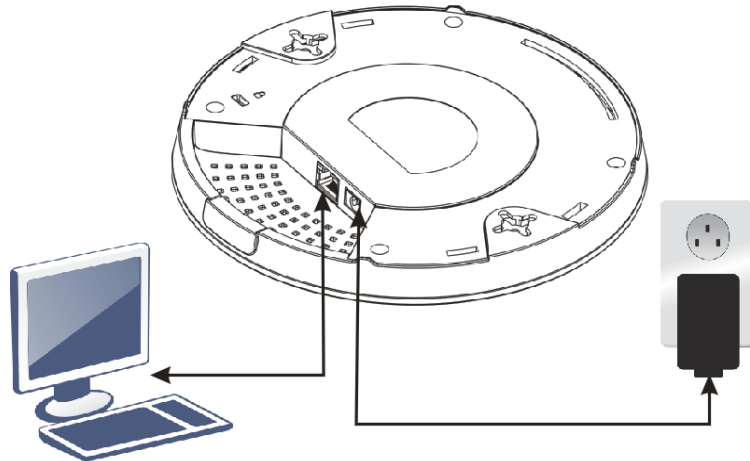

4. Set the IP address of the PC as "192.168.1.x (x means any number, ranges from 3 to 100).
5. Open a web browser on your PC and type **http://192.168.1.2**. The following window will be open to ask for username and password. Type "admin/admin" and click **Login**.

A screenshot of the DrayTek VigorAP 960C login page. The page features the DrayTek logo and the model name 'VigorAP 960C' in red. On the right side, there are two input fields labeled 'User Name' and 'Password'. Below these fields is a red button labeled 'Login'.

6. Main screen will be displayed.

Before using VigorAP, finish the following web configuration first.

- Configuring LAN IP address(es)
- SSID and Security setting for 2.4G and 5GHz.
- Administrator's name and password.
- Time and date.

For detailed, refer to Section I-4 Accessing to Web User Interface.

I-3 Network IP Configuration

After the network connection is built, the next step you should do is setup VigorAP with proper network parameters, so it can work properly in your network environment.

Before you can connect to the access point and start configuration procedures, your computer must be able to get an IP address in the same subnet as this AP. If it's not connected to the same DHCP Server with the AP or you're unsure, please follow the following instructions to configure your computer to use the static IP address in the same subnet as default IP address of this AP.

For the default IP address of this AP is set "192.168.1.2", we recommend you to use "192.168.1.X (except 2)" in the field of IP address on this section for your computer.

I-3-1 Windows 10 IP Address Setup

Click the **Start** button (it should be located at lower-left corner of your computer), then click the **Settings** icon.

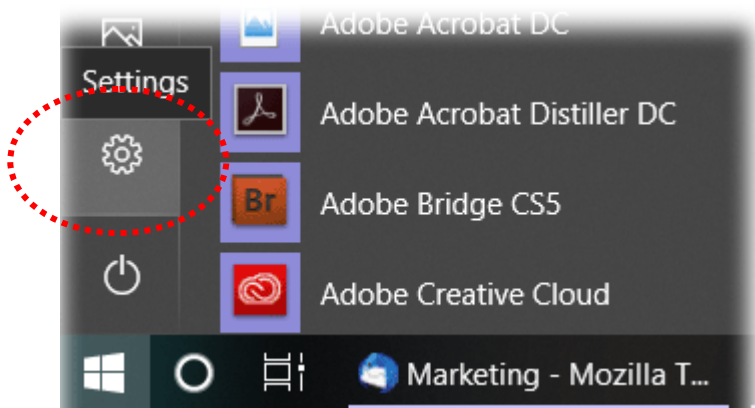

Double-click **Network & Internet**.

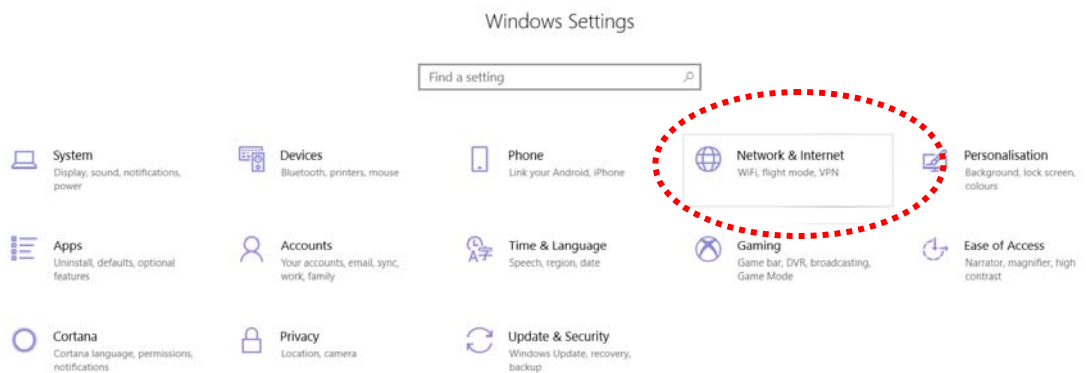

Next, click **Change adapter options**.

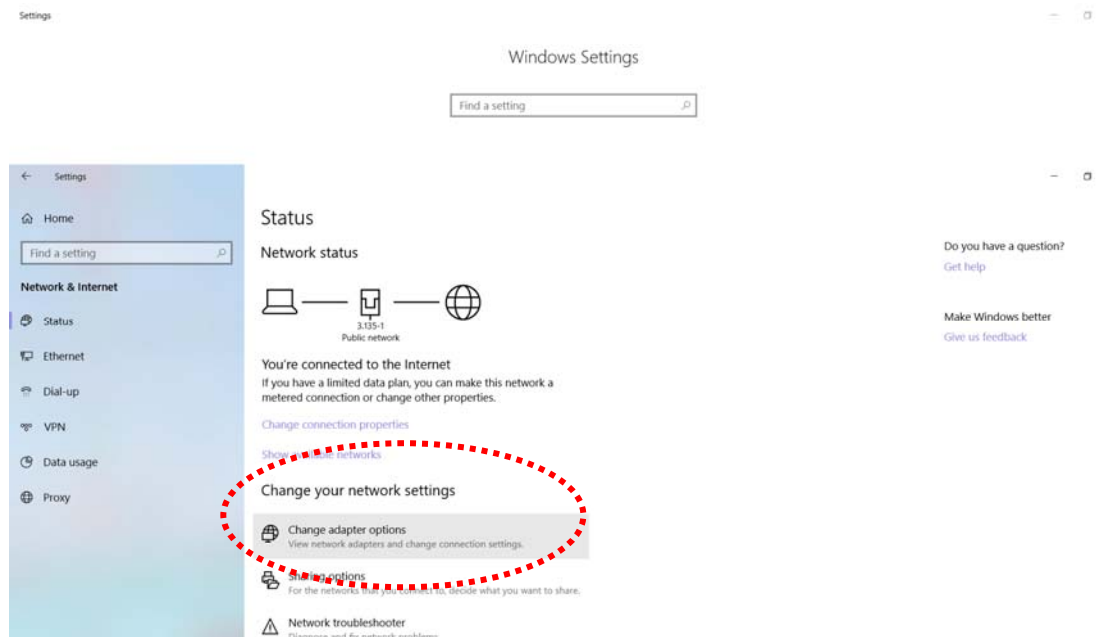

Click the local area connection.

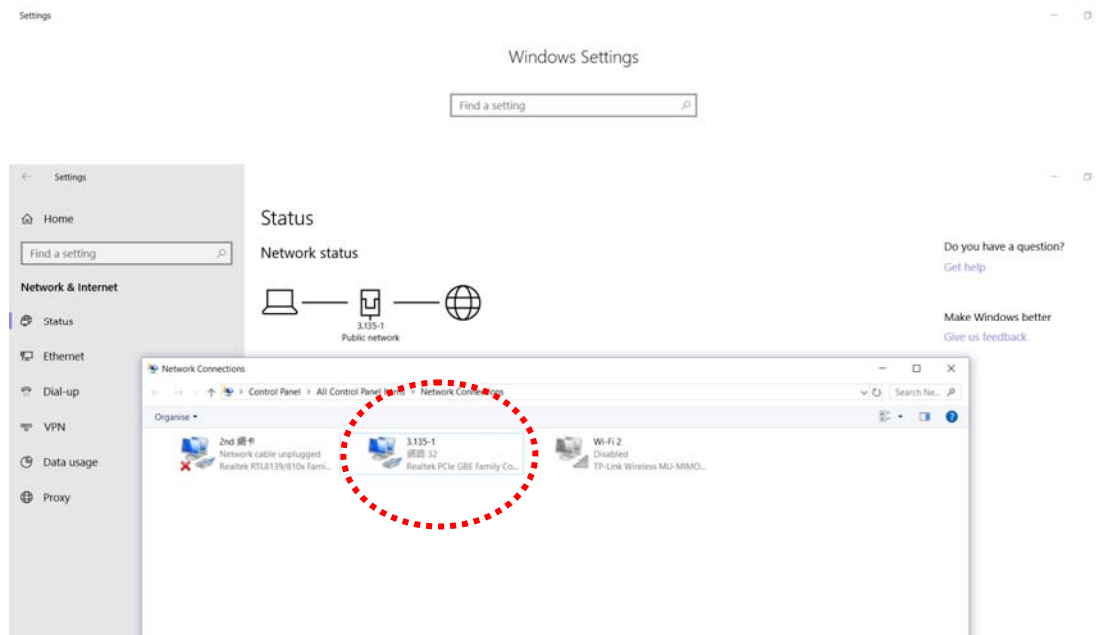

Then, select **Internet Protocol Version 4 (TCP/IPv4)** and click **Properties**.

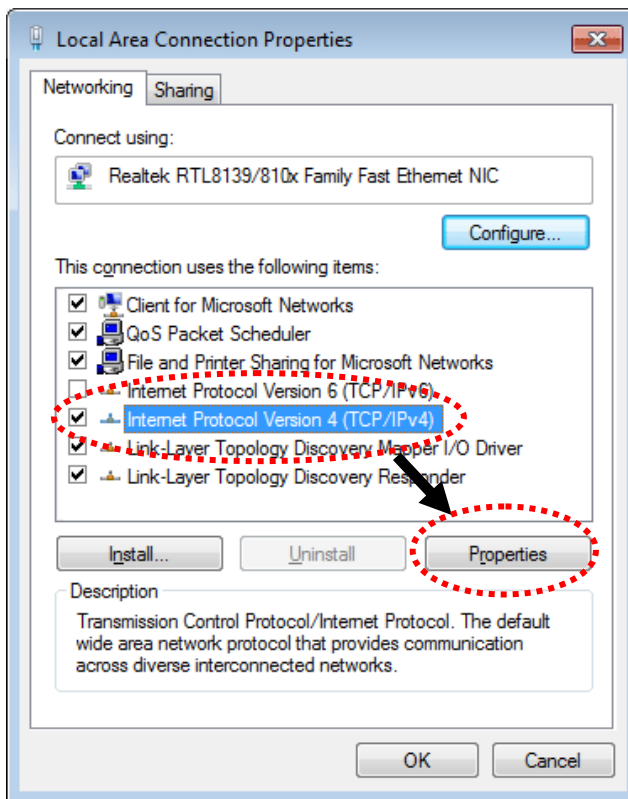

Under the General tab, click **Use the following IP address**. Then input the following settings in respective field and click **OK** when finish.

IP address: **192.168.1.9**

Subnet Mask: **255.255.255.0**

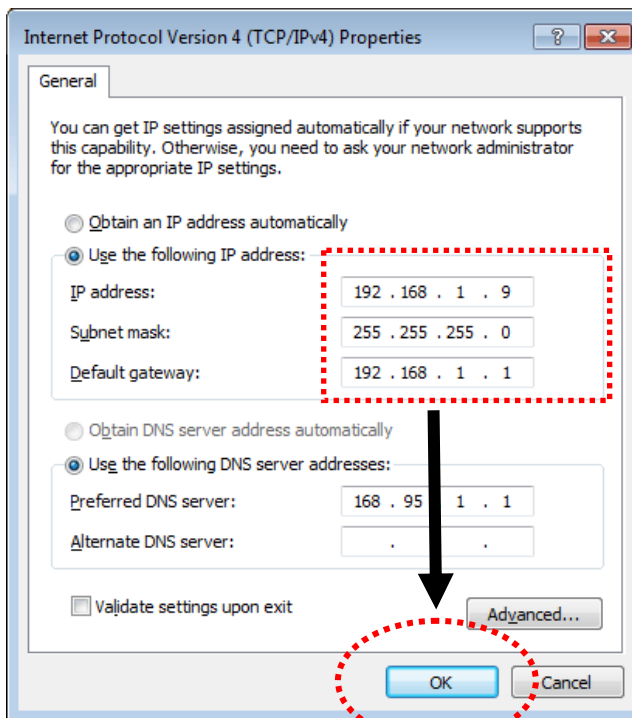

I-4 Accessing to Web User Interface

All functions and settings of this access point must be configured via web user interface. Please start your web browser (e.g., Firefox).

1. Make sure your PC connects to the VigorAP 960C correctly.
2. Open a web browser on your PC and type **http://192.168.1.2**. A pop-up window will open to ask for username and password. Please type "admin/admin" on Username/Password and click **OK**.

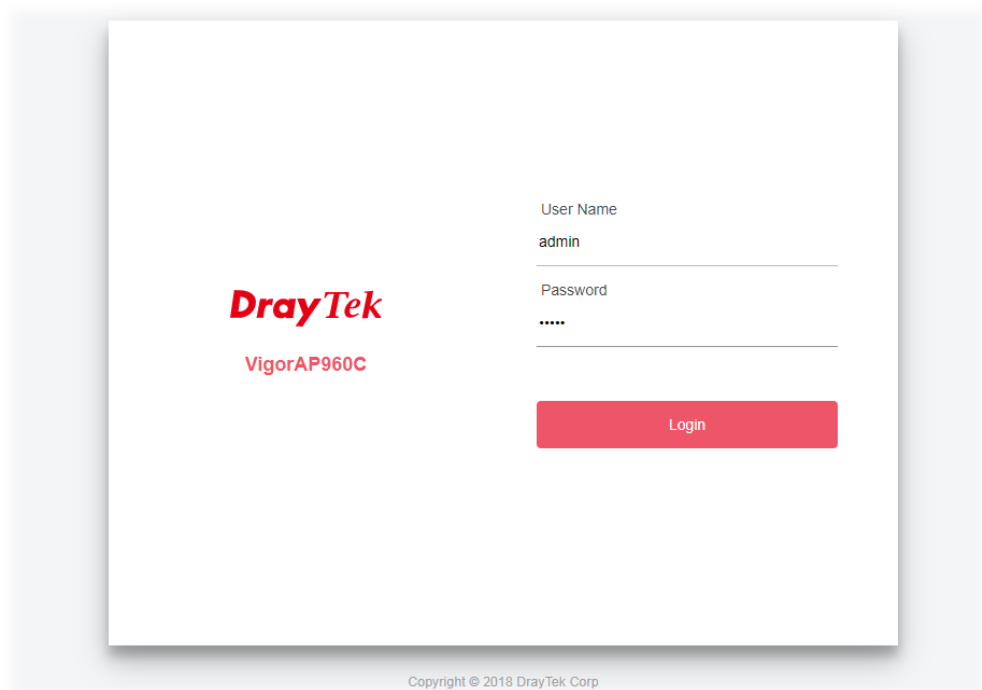

i Note:

You may either simply set up your computer to get IP dynamically from the router or set up the IP address of the computer to be in the same subnet as **the IP address of VigorAP 960C**.

- If there is no DHCP server on the network, then VigorAP 960C will have an IP address of 192.168.1.2.
 - If there is DHCP available on the network, then VigorAP 960C will receive its IP address via the DHCP server.
 - If you connect to VigorAP by wireless LAN, you could try to access the web user interface through <http://vigorap.com>.
-

- For the first time accessing VigorAP, the **Quick Start Wizard** for configuring wireless settings will appear as follows. Refer to [Section I-7 Quick Start Wizard for detailed information](#).

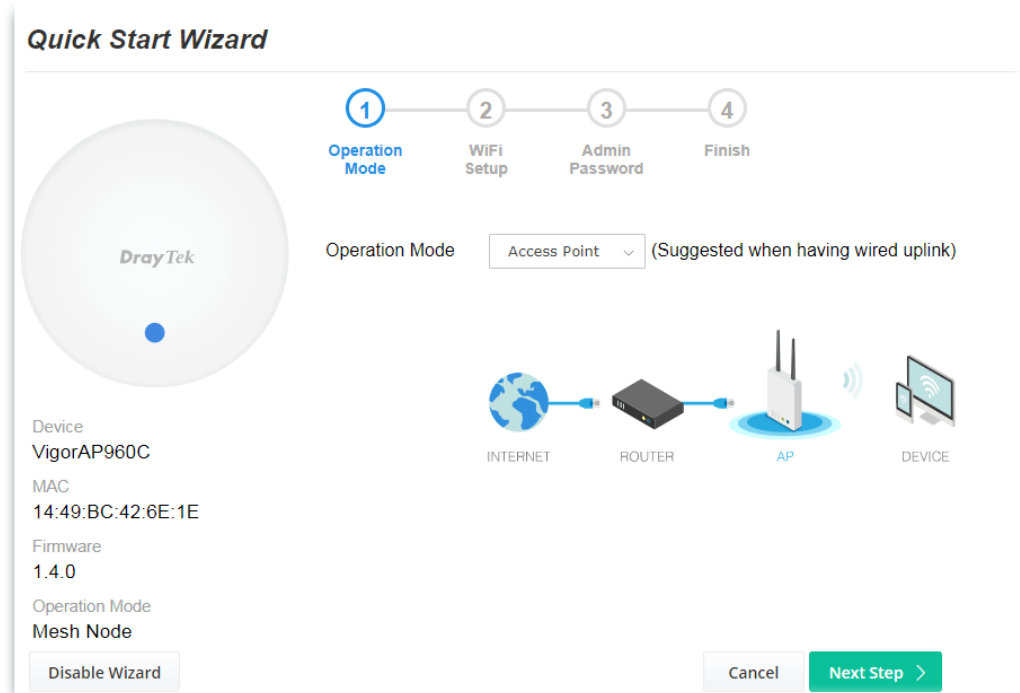

- If VigorAP has been configured previously, the Dashboard of VigorAP will appear as follows:

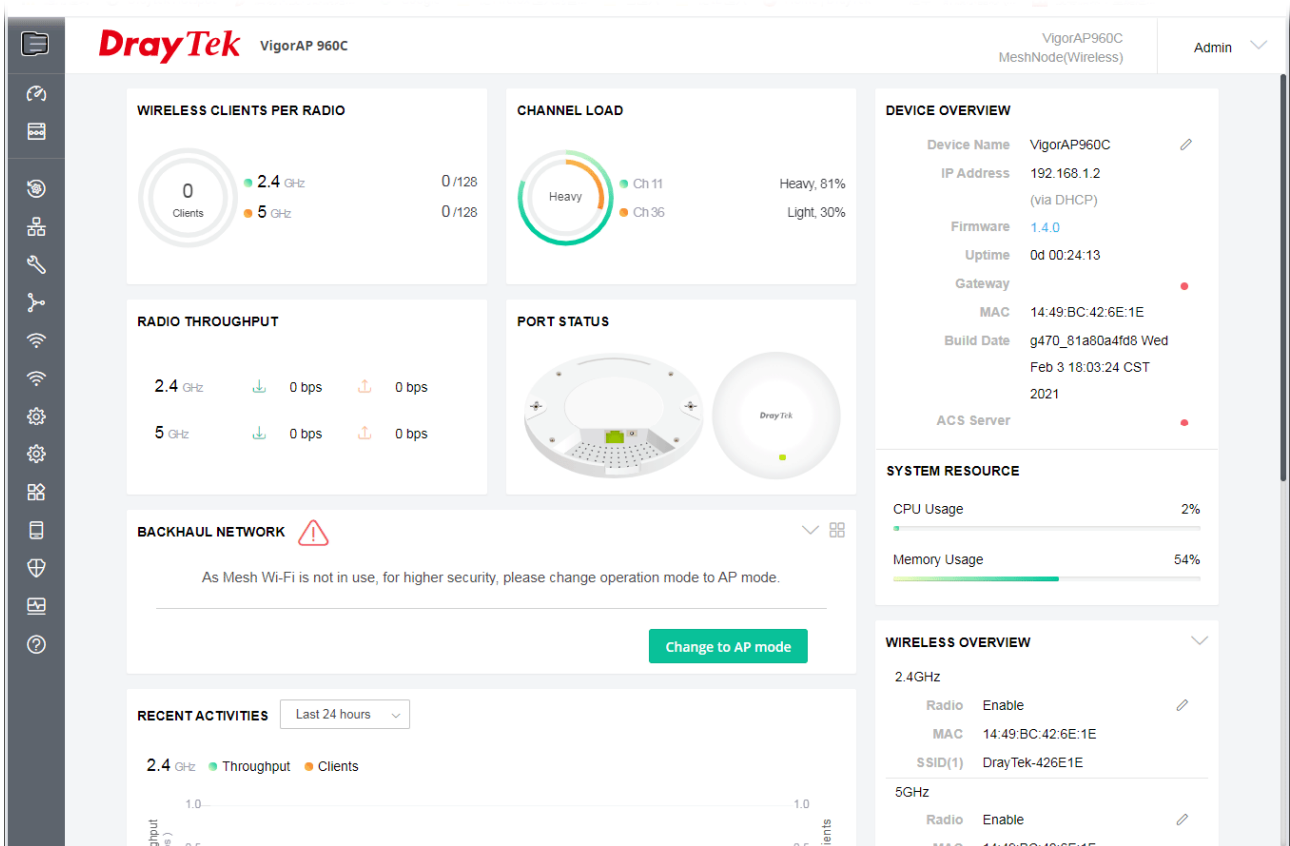

- The web page can be logged out by clicking **Log Out** on the top right of the web page. Or, logout the web user interface according to the chosen condition. The default setting is **Auto Logout**, which means the web configuration system will logout after 5 minutes without any operation. Change the setting of auto logout if you want.

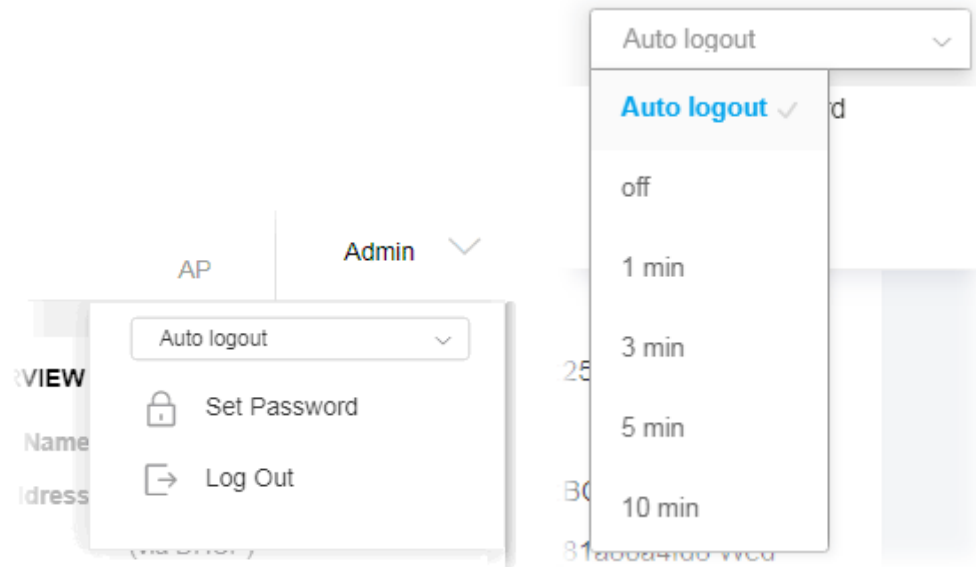

i Note:

If you fail to access the web configuration, please go to the section “Trouble Shooting” for detecting and solving your problem.

For using the device properly, it is necessary for you to change the password of web configuration for security and adjust primary basic settings.

I-5 Changing Password

1. Please change the password for the original security of the modem.
2. Go to **System Maintenance** page and choose **Administration Password**.

System Maintenance >> Administration Password

Administrator Settings

| | |
|--------------------|-------------------------------------------------------------------------------------------------|
| Account | <input type="text" value="admin"/> |
| Old Password | <input type="password" value="....."/> |
| New Password | <input type="password" value="....."/> |
| Confirm Password | <input type="password" value="....."/> |
| Password Strength: | <input type="radio"/> Weak <input checked="" type="radio"/> Medium <input type="radio"/> Strong |

Strong password requirements:
1. Have at least one upper-case letter and one lower-case letter.
2. Including non-alphanumeric characters is a plus.

Note : Authorization Account can contain only a-z A-Z 0-9 , ~ ` ! @ \$ % ^ * () _ - + = { } [] | ; < > . ?
Authorization Password can contain only a-z A-Z 0-9 , ~ ` ! @ # \$ % ^ & * () _ - + = { } [] | \ ; < > . ? /

3. Enter the new login password on the field of **Password**. Then click **OK** to continue.
4. Now, the password has been changed. Next time, use the new password to access the Web User Interface for this modem.

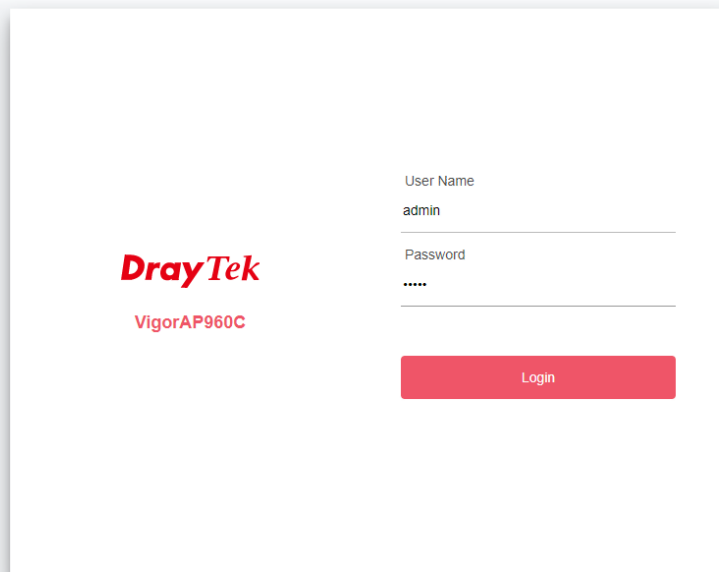

The image shows the login page for a DrayTek VigorAP960C modem. On the left, the DrayTek logo is displayed in red, with the model name 'VigorAP960C' below it. On the right, there are two input fields: 'User Name' with 'admin' entered, and 'Password' with '.....' entered. Below these fields is a red 'Login' button. At the bottom of the page, there is a small copyright notice: 'Copyright © 2018 DrayTek Corp'.

I-6 Dashboard

Dashboard shows system status including the number of client connected, throughput, gateway, physical connection status, radio (2.4GHz / 5GHz) status, backhaul network, recent activities, wireless network usage, and so on.

Click **Dashboard** from the main menu on the left side of the main page.

The screenshot displays the DrayTek VigorAP960C dashboard. The interface includes a left-hand navigation menu with options like Dashboard, Quick Start Wizard, Operation Mode, LAN, Central AP Management, Mesh, Wireless LAN (2.4GHz), Wireless LAN (5GHz), RADIUS Setting, Objects Setting, Applications, Mobile Device Management, System Maintenance, Diagnostics, and Support. The main content area is divided into several sections:

- WIRELESS CLIENTS PER RADIO:** Shows 0 clients for both 2.4 GHz and 5 GHz bands, with a capacity of 0/128 for each.
- CHANNEL LOAD:** Shows 'Light' load for both Ch 11 (2.4 GHz) and Ch 36 (5 GHz), with 0% usage.
- RADIO THROUGHPUT:** Shows 0 bps for both 2.4 GHz and 5 GHz bands.
- PORT STATUS:** Displays a physical port status diagram.
- BACKHAUL NETWORK:** Shows a warning icon and a message: "As Mesh Wi-Fi is not in use, for higher security, please change operation mode to AP mode." A "Change to AP mode" button is present.
- RECENT ACTIVITIES:** Shows a graph for the last 24 hours, with 0.0 activity for both Throughput and Clients.
- DEVICE OVERVIEW:** Lists device details: Device Name (VigorAP960C), IP Address (192.168.1.2), Firmware (1.4.0), Uptime (0d 00:28:48), Gateway (MAC: 14:49:BC:42:6E:1E), Build Date (Feb 3 18:03:24 CST 2021), and ACS Server status.
- SYSTEM RESOURCE:** Shows CPU Usage at 6% and Memory Usage at 54%.
- WIRELESS OVERVIEW:** Shows 2.4GHz Radio (Enable) and 5GHz Radio (Enable).

I-7 Quick Start Wizard

Quick Start Wizard will guide you to configure 2.4G wireless setting, 5G wireless setting and other corresponding settings for Vigor Access Point step by step.

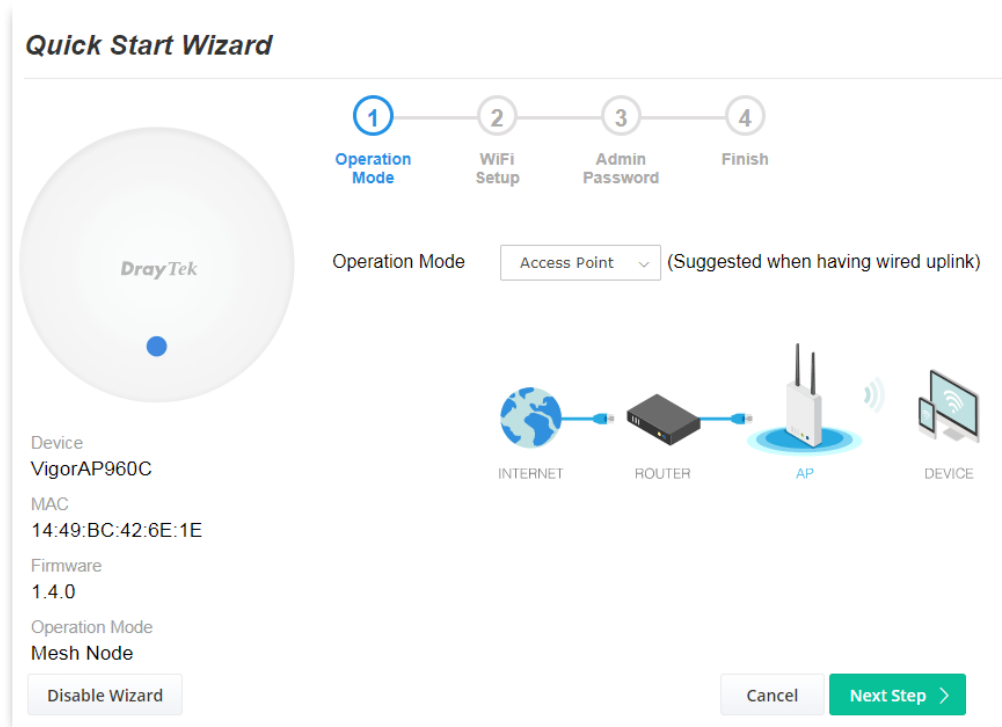

Available operation mode includes:

- Access Point
- Mesh Root
- Mesh Node
- Range Extender

In this page, the advanced settings pages will vary according to the operation mode specified.

I-7-1 Settings for Access Point

1. Choose **Access Point** as the operation mode and click **Next Step**.

Quick Start Wizard



Device
VigorAP960C
MAC
14:49:BC:42:6E:1E
Firmware
1.4.0
Operation Mode
Mesh Node

1 Operation Mode 2 WiFi Setup 3 Admin Password 4 Finish

Operation Mode (Suggested when having wired uplink)

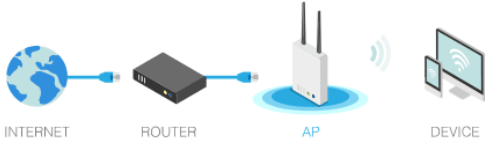

INTERNET ROUTER AP DEVICE

2. In the following page, configure the settings for wireless LAN (for both 2.4GHz and 5GHz) and click **Next Step**.

Quick Start Wizard



Device
VigorAP960C
MAC
14:49:BC:42:6E:1E
Firmware
1.4.0
Operation Mode
Mesh Node

1 Operation Mode 2 WiFi Setup 3 Admin Password 4 Finish

Your AP is under default config. Please setup first.

WiFi Name:

WiFi Password:

Enable 2nd WiFi

Note: The WiFi settings will apply to all Wireless bands.

Available settings are explained as follows:

| Item | Description |
|-------------------------------|------------------------------------------------------------------------------------------------------------------------------------------------------------------------------------------------------------------------------------------------------------------------------------------------------------------------------------------------------------------------------------------------------------------------------------------------------------------------------------------------------------------------------------------|
| WiFi Name | Set a name for VigorAP 960C to be identified. |
| WiFi Password | Type 8~63 ASCII characters, such as 012345678...(or 64 Hexadecimal digits leading by 0x, such as "0x321253abcde..."). |
| Enable 2nd WiFi | <p>Check the box to enable the second wireless setting.</p> <p>Such feature is especially useful for free Wi-Fi service. For example, a coffee shop offers free Wi-Fi service for its guests for one hour every day.</p> <p>2nd WiFi Name - Set a name for VigorAP 960C which can be identified and connected by wireless guest.</p> <p>2nd WiFi Password - Set 8~63 ASCII characters or 64 Hexadecimal digits leading by 0x which can be used for logging into VigorAP device by wireless guest.</p> |
| Enable Station Control | <p>Check the box to set the duration for the guest connecting /reconnecting to Vigor device.</p> <p>Connection Time – Scroll the radio button to choose the value you want.</p> <p>Reconnection Time – Scroll the radio button to choose the value you want.</p> |

3. Change the default password for such device with new value. Then click **Next Step**.

Quick Start Wizard



① Operation Mode
② WiFi Setup
③ Admin Password
④ Finish

Your AP is under default config. Please setup first.

Admin Password:

Confirm Password:

Device
VigorAP960C

MAC
14:49:BC:42:6E:1E

Firmware
1.4.0

Operation Mode
Mesh Node

< Back
Cancel Next Step >

Available settings are explained as follows:

| Item | Description |
|------|-------------|
|------|-------------|

| | |
|-------------------------|------------------------------------------------|
| Admin Password | Enter a new password. |
| Confirm Password | Enter the new password again for confirmation. |

4. A summary of settings configuration will be shown on screen. Click **Finish**.

Quick Start Wizard



1

Operation Mode

2

WiFi Setup

3

Admin Password

4

Finish

Basic settings are completed. Press Finish button apply changes.

| | |
|-----------------|----------------|
| Operation Mode | Pure AP |
| WiFi Name | DrayTek-426E1E |
| 2nd WiFi Name | Disabled |
| Station Control | Enabled |

Device
VigorAP960C

MAC
14:49:BC:42:6E:1E

Firmware
1.4.0

Operation Mode
Mesh Node

< Back

Cancel

Finish

I-7-2 Settings for Mesh Root

1. Choose **Mesh Root** as the operation mode and click **Next Step**.

Quick Start Wizard



1 Operation Mode 2 WiFi Setup 3 Admin Password 4 Finish

Operation Mode:

Group Name:

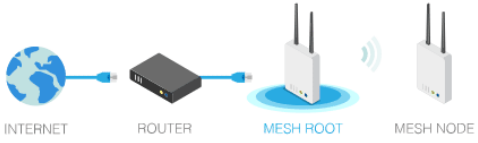

Device: VigorAP960C
 MAC: 14:49:BC:42:6E:1E
 Firmware: 1.4.0
 Operation Mode: Mesh Node

2. Configure the settings for wireless LAN (for both 2.4GHz and 5GHz) and click **Next Step**.

Quick Start Wizard



1 Operation Mode 2 WiFi Setup 3 Admin Password 4 Finish

Your AP is under default config. Please setup first.

WiFi Name:

WiFi Password:

Enable 2nd WiFi

2nd WiFi Name:

2nd WiFi Password:

Enable Station Control

Connection Time: Min(s)
 4days 0hours 0mins

Reconnection Time: Min(s)
 4days 0hours 0mins

Note: The WiFi settings will apply to all Wireless bands.

Available settings are explained as follows:

| Item | Description |
|------------------|-----------------------------------------------|
| WiFi Name | Set a name for VigorAP 960C to be identified. |

| | |
|-------------------------------|-------------------------------------------------------------------------------------------------------------------------------------------------------------------------------------------------------------------------------------------------------------------------------------------------------------------------------------------------------------------------------------------------------------------------------------------------------------------------------------------------------------------|
| WiFi Password | Type 8~63 ASCII characters, such as 012345678..(or 64 Hexadecimal digits leading by 0x, such as "0x321253abcde..."). |
| Enable 2nd WiFi | <p>Check the box to enable the second wireless setting.</p> <p>Such feature is especially useful for free Wi-Fi service. For example, a coffee shop offers free Wi-Fi service for its guests for one hour every day.</p> <p>2nd WiFi Name - Set a name for VigorAP 960C which can be identified and connected by wireless guest.</p> <p>2nd WiFi Password - Set 8~63 ASCII characters or 8~63 ASCII characters which can be used for logging into VigorAP 960C by wireless guest.</p> |
| Enable Station Control | <p>Check the box to set the duration for the guest connecting /reconnecting to Vigor device.</p> <p>Connection Time -Scroll the radio button to choose the value you want.</p> <p>Reconnection Time -Scroll the radio button to choose the value you want.</p> |

3. Change the default password for such device with new value. Then click **Next Step**.

Quick Start Wizard



1 — 2 — 3 — 4

Operation Mode WiFi Setup **Admin Password** Finish

Your AP is under default config. Please setup first.

Admin Password:

Confirm Password:

Device
VigorAP960C

MAC
14:49:BC:42:6E:1E

Firmware
1.4.0

Operation Mode
Mesh Node

< Back
Cancel Next Step >

Available settings are explained as follows:

| Item | Description |
|-------------------------|------------------------------------------------|
| Admin Password | Enter a new password. |
| Confirm Password | Enter the new password again for confirmation. |

4. A summary of settings configuration will be shown on screen. Click **Finish**.

Quick Start Wizard



1 Operation Mode 2 WiFi Setup 3 Admin Password 4 Finish

Basic settings are completed. Press Finish button apply changes.

| | |
|-----------------|----------------|
| Operation Mode | Mesh Root |
| WiFi Name | DrayTek-426E1E |
| 2nd WiFi Name | Disabled |
| Station Control | Enabled |

Device
VigorAP960C
MAC
14:49:BC:42:6E:1E
Firmware
1.4.0
Operation Mode
Mesh Node

< Back Cancel Finish

5. After clicking **Finish**, the following web page appears. VigorAP will search for mesh node around the network.

Quick Start Wizard



1 Restart Wireless 2 Mesh Node Setup 3 Finish

Setup additional VigorAPs to Mesh network?
Please power up and wait for us to find it.

| | |
|----------------|-------------------|
| Device | VigorAP960C |
| MAC | 14:49:BC:42:6E:1E |
| Firmware | 1.4.0 |
| Operation Mode | Mesh Root |

Sending settings to mesh node

< Back Cancel Apply

- Available VigorAP devices will be shown on the screen. Select the device (as a mesh node) for grouping under such mesh group and enter a device name for identification.

Quick Start Wizard



1 Restart Wireless 2 Mesh Node Setup 3 Finish

Setup additional VigorAPs to Mesh network?
Please power up and wait for us to find it.

| Select | Model | MAC | Device Name |
|-------------------------------------|--------------|-------------------|----------------------|
| <input type="checkbox"/> | VigorAP1060C | 00:1D:AA:95:43:78 | <input type="text"/> |
| <input checked="" type="checkbox"/> | VigorAP920R | 00:1D:AA:22:33:44 | <input type="text"/> |

Device
VigorAP960C
MAC
14:49:BC:42:6E:1E
Firmware
1.4.0
Operation Mode
Mesh Root

Sending settings to mesh node

- Click **Apply** and wait for a while.

Quick Start Wizard



1 Restart Wireless 2 Mesh Node Setup 3 Finish

Setup additional VigorAPs to Mesh network?
Please power up and wait for us to find it.

| Select | Model | MAC | Device Name |
|-------------------------------------|--------------|-------------------|----------------------|
| <input type="checkbox"/> | VigorAP1060C | 00:1D:AA:95:43:78 | <input type="text"/> |
| <input checked="" type="checkbox"/> | VigorAP920R | 00:1D:AA:22:33:44 | 920R |

Device
VigorAP960C
MAC
14:49:BC:42:6E:1E
Firmware
1.4.0
Operation Mode
Mesh Root

Sending settings to mesh node



8. Later, a summary page of mesh root with mesh node will be shown on the screen.

Quick Start Wizard



1 Restart Wireless 2 Mesh Node Setup 3 Finish

Setup 1 Mesh Root and 1 Mesh Node completed.

| | | | | | |
|------|-----------------------------------------------------------------------------------|----------------------------|--------|--------|-------------------|
| ROOT |  | VigorAP960C VigorAP960C | | 1 Node | 1 Offline |
| |  | 920R VigorAP920R | -55dbm | | 00:1D:AA:68:D6:68 |

Device
VigorAP960C
MAC
14:49:BC:42:6E:1E
Firmware
1.4.0
Operation Mode
Mesh Root

< Back Cancel Finish

I-7-3 Settings for Mesh Node

1. Choose **Mesh Node** as the operation mode and click **Next Step**.

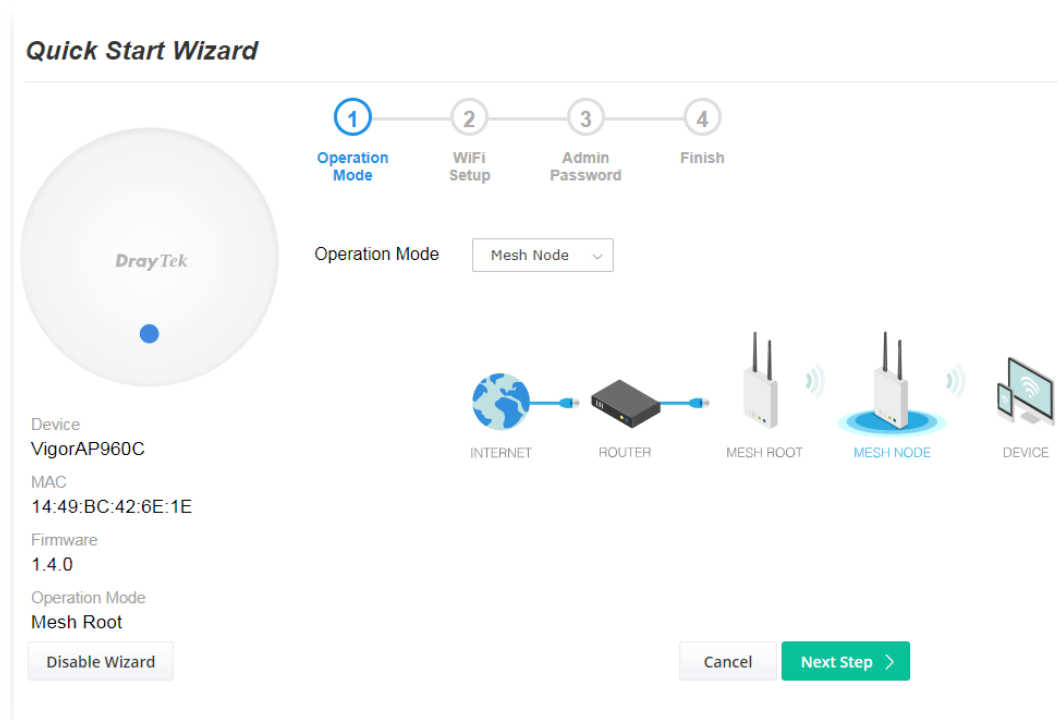

2. A summary of settings configuration will be shown on screen. Click **Finish**.

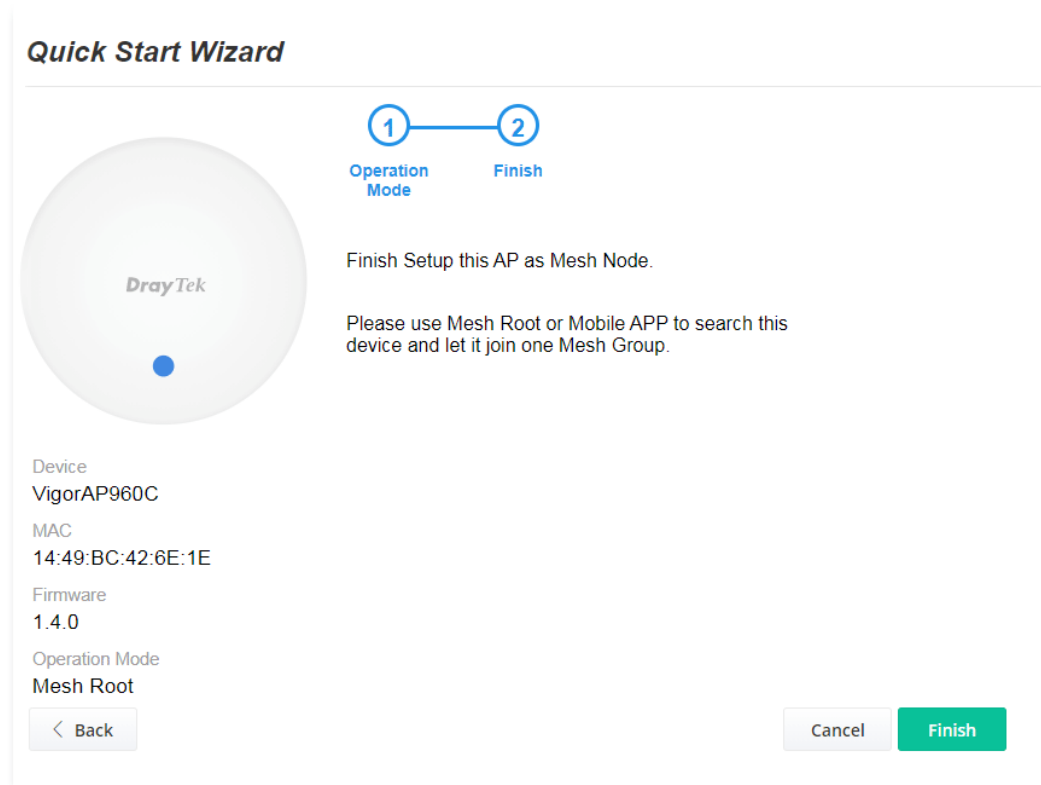

I-7-4 Settings for Range Extender

1. Choose **Range Extender** as the operation mode and click **Next Step**.

Quick Start Wizard



Device
VigorAP960C
MAC
14:49:BC:42:6E:1E
Firmware
1.4.0
Operation Mode
Mesh Root

1 Operation Mode 2 WiFi Setup 3 Admin Password 4 Finish

Operation Mode



AP RANGE EXTENDER DEVICE

2. Configure the settings for wireless LAN (for both 2.4GHz and 5GHz) and click **Next Step**.

Quick Start Wizard



Device
VigorAP960C
MAC
14:49:BC:42:6E:1E
Firmware
1.4.0
Operation Mode
Mesh Root

1 Operation Mode 2 WiFi Setup 3 Admin Password 4 Range Extender 5 Finish

Your AP is under default config. Please setup first.

WiFi Name:
WiFi Password:

Enable 2nd WiFi
2nd WiFi Name:
2nd WiFi Password:

Enable Station Control
Connection Time Min(s)
4days 0hours 0mins
Reconnection Time Min(s)
4days 0hours 0mins

Note: The WiFi settings will apply to all Wireless bands.

Available settings are explained as follows:

| Item | Description |
|-------------------------------|----------------------------------------------------------------------------------------------------------------------------------------------------------------------------------------------------------------------------------------------------------------------------------------------------------------------------------------------------------------------------------------------------------------------------------------------------------------------------------------------------------------------------------|
| WiFi Name | Set a name for VigorAP 960C to be identified. |
| WiFi Password | Type 8~63 ASCII characters, such as 012345678..(or 64 Hexadecimal digits leading by 0x, such as "0x321253abcde..."). |
| Enable 2nd WiFi | <p>Check the box to enable the second wireless setting.</p> <p>Such feature is especially useful for free Wi-Fi service. For example, a coffee shop offers free Wi-Fi service for its guests for one hour every day.</p> <p>2nd WiFi Name - Set a name for VigorAP 960C which can be identified and connected by wireless guest.</p> <p>2nd WiFi Password - Set 8~63 ASCII characters or 64 Hexadecimal digits leading by 0x which can be used for logging into VigorAP 1000C by wireless guest.</p> |
| Enable Station Control | <p>Check the box to set the duration for the guest connecting /reconnecting to Vigor device.</p> <p>Connection Time -Scroll the radio button to choose the value you want.</p> <p>Reconnection Time -Scroll the radio button to choose the value you want.</p> |

3. Change the default password for such device with new value. Then click **Next Step**.

Quick Start Wizard

1 Operation Mode 2 WiFi Setup 3 Admin Password 4 Range Extender 5 Finish

DrayTek

Your AP is under default config. Please setup first.

Admin Password:

Confirm Password:

Device
VigorAP960C
MAC
14:49:BC:42:6E:1E
Firmware
1.4.0
Operation Mode
Mesh Root

< Back Cancel Next Step >

Available settings are explained as follows:

| Item | Description |
|-----------------------|-----------------------|
| Admin Password | Enter a new password. |

| | |
|-------------------------|------------------------------------------------|
| Confirm Password | Enter the new password again for confirmation. |
|-------------------------|------------------------------------------------|

4. In the following page, click **Search** to find out neighboring access point. When all the available access points appear on the page, click the one you want to connect. Corresponding settings (e.g., SSID, Security Mode) of the selected device will be shown below. Enter the Security Key. Then click **Next Step**.

Quick Start Wizard

1 Operation Mode | 2 WiFi Setup | 3 Admin Password | 4 Range Extender | 5 Finish

2.4GHz WLAN 5GHz WLAN

| SSID | BSSID | RSSI | Channel | Encryption | Authentication |
|------------------------------------------|-------------------|-------------|---------|------------|--------------------|
| <input type="radio"/> DrayTek | 00:50:7F:E4:8D:DC | 32%(-82dbm) | 11 | NONE | |
| <input type="radio"/> DrayTek | 00:1D:AA:F7:C0:E0 | 87%(-66dbm) | 6 | NONE | |
| <input type="radio"/> PQC Justin V291... | 02:1D:AA:C5:B6:E0 | 92%(-62dbm) | 11 | NONE | |
| <input type="radio"/> DrayTek | 00:1D:AA:ED:38:40 | 28%(-83dbm) | 6 | AES | WPA2 Personal |
| <input type="radio"/> DrayTek | 00:1D:AA:80:06:C4 | 96%(-57dbm) | 11 | AES | WPA2 Personal |
| <input type="radio"/> DrayTek | 00:1D:AA:22:33:44 | 19%(-86dbm) | 11 | TKIP/AES | WPA2/WPA Personal |
| <input type="radio"/> ASUS_44 | 18:31:BF:C0:70:44 | 19%(-86dbm) | 11 | AES | WPA2 Personal |
| <input type="radio"/> staffs | 00:1D:AA:3F:4F:44 | 15%(-87dbm) | 11 | AES | WPA2 Personal |
| <input type="radio"/> monitor | 06:1D:AA:3F:4F:44 | 19%(-86dbm) | 11 | AES | WPA2 Personal |
| <input type="radio"/> DrayTek | 12:1D:AA:22:33:44 | 22%(-85dbm) | 11 | AES | WPA2 Personal |
| <input type="radio"/> staffs_55 | 12:1D:AA:3F:4F:44 | 19%(-86dbm) | 11 | AES | WPA2 Personal |
| <input type="radio"/> staffs_55 | 00:1D:AA:3E:4E:5E | 87%(-66dbm) | 1 | AES | WPA2/WPA2 Personal |

Device: VigorAP960C
MAC: 14:49:BC:42:6E:1E
Firmware: 1.4.0
Operation Mode: Mesh Root

SSID: Channel: 2462MHz (Channel 11) Security Mode: WPA2 Personal Encryption Type: AES

Security Key:

Available settings are explained as follows:

| Item | Description |
|--------------------------|----------------------------------------------------------------------------------------------------------------------------------------------------------------------------------------------------------------------------------------------------------------------------------------------------------------------------------------------------------------------------------------------------------------------------------------------------------------------------------------------------------------------------------------------------------------------------------------------------------------------------------------------------------------------------------------------------------------------------------------------------------------------------------------------------------------------------------------------------------------------------------------------------------------------------------------------------------------------|
| SSID/Security Key | Once the access point specified above, the name / security key of the AP will be shown automatically in these fields. |
| Channel | Means the channel frequency of the wireless LAN. You may switch channel if the selected channel is under serious interference. |
| Security Mode | There are several modes provided for you to choose. Each mode will bring up different parameters (e.g., WEP keys, Pass Phrase) for you to configure. |
| Encryption Type | Available options will vary according to the selected Security Mode . When Open is selected: <ul style="list-style-type: none"> Choose None to disable the WEP Encryption. Data sent to the AP will not be encrypted. WEP Keys -To enable WEP encryption for data transmission, please choose WEP. Four keys can be entered here, but only one key can be selected at a time. The format of WEP Key is restricted to 5 ASCII characters or 10 hexadecimal values in 64-bit encryption level, or restricted to 13 ASCII characters or 26 hexadecimal values in 128-bit encryption level. The allowed content is the ASCII characters from 33(!) to 126(~) except '#' and '.'. When Shared is selected: <ul style="list-style-type: none"> WEP Keys - To enable WEP encryption for data transmission, please choose WEP. Four keys can be entered here, but only one |

key can be selected at a time. The format of WEP Key is restricted to 5 ASCII characters or 10 hexadecimal values in 64-bit encryption level, or restricted to 13 ASCII characters or 26 hexadecimal values in 128-bit encryption level. The allowed content is the ASCII characters from 33(!) to 126(~) except '#' and ','.

When WPA/PSK or WPA2/PSK is selected:

- Select **TKIP** or **AES** as the algorithm for WPA.
- **Security Key** - Select WEP, TKIP or AES as the encryption algorithm.

Type **8~63** ASCII characters, such as 012345678..(or 64 Hexadecimal digits leading by 0x, such as "0x321253abcde...").

5. A summary of settings configuration will be shown on screen. Click **Finish**.

Quick Start Wizard

1 Operation Mode 2 WiFi Setup 3 Admin Password 4 Range Extender 5 Finish

Basic settings are completed. Press Finish button apply changes.

| | |
|-----------------|------------------------------|
| Operation Mode | Range Extender (2.4GHz WLAN) |
| Peer SSID | 12345678 |
| WiFi Name | DrayTek-426E1E |
| 2nd WiFi Name | Disabled |
| Station Control | Disabled |

Device
VigorAP960C
MAC
14:49:BC:42:6E:1E
Firmware
1.4.0
Operation Mode
Mesh Root

< Back Cancel Finish

This page is left blank.

Chapter II Connectivity

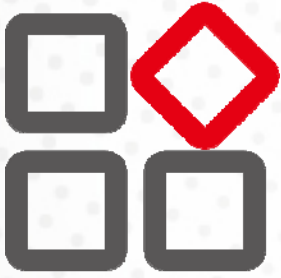

II-1 Operation Mode

This page provides several available modes for you to choose for different conditions. Click any one of them and click **OK**. The system will configure the required settings automatically.

Operation Mode Configuration

AP :

VigorAP acts as a bridge between wireless devices and wired Ethernet network, and exchanges data between them.

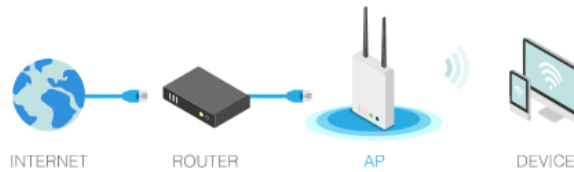

Mesh :

Mesh Root:

AP connects to gateway with Ethernet cable. It would be other AP's uplink connection.

Mesh Node:

Use wireless to connect to other Mesh Root when Ethernet cable doesn't exist. A mesh network creates a set of links automatically and calculate the most optimal wireless path through the wireless network back to a wired Mesh Root.

Range Extender :

VigorAP can act as a wireless repeater; it can be Station and AP at the same time.

OK

Available settings are explained as follows:

| Item | Description |
|-----------------------|-------------------------------------------------------------------------------------------------------------------------------------------------------------------------------------------------------------------------------------------------------------------------------------------------------------------------------------------|
| AP | This mode allows wireless clients to connect to access point and exchange data with the devices connected to the wired network. |
| Mesh | <p>Mesh Root – VigorAP must connect to a gateway with an Ethernet cable.</p> <p>Mesh Node – VigorAP can connect to other mesh root via wireless connection. A mesh network creates one set of links automatically and calculates the most optimal wireless path through the wireless network back to a wired mesh root.</p> |
| Range Extender | VigorAP can act as a wireless repeater which will help you to extend the networking wirelessly. The access point can act as Station and AP at the same time. It can use Station function to connect to a Root AP and use AP function to service all wireless clients within its coverage. |

 Note:

The Wireless LAN settings will be changed according to the Operation Mode selected here. For the detailed information, please refer to the section of Wireless LAN.

II-2 General Concepts for Wireless LAN (2.4GHz/5GHz)

VigorAP 960C is a highly integrated wireless local area network (WLAN) for 2.4/5 GHz 802.11b/g/n/ax WLAN applications. It supports channel operations of 20/40 MHz at 2.4 GHz and 20/40/80 MHz at 5 GHz. VigorAP 960C can support data rates up to 1.2 GBps in 802.11ax 80/160 MHz bandwidth.

Note:

* The actual data throughput will vary according to the network conditions and environmental factors, including volume of network traffic, network overhead and building materials.

VigorAP 960C plays a role as an Access Point (AP) connecting to lots of wireless clients or Stations (STA). All the STAs will share the same Internet connection via VigorAP 960C. The **General Setup** will set up the information of this wireless network, including its SSID as identification, located channel etc.

Security Overview

WEP (Wired Equivalent Privacy) is a legacy method to encrypt each frame transmitted via radio using either a 64-bit or 128-bit key. Usually access point will preset a set of four keys and it will communicate with each station using only one out of the four keys.

WPA (Wi-Fi Protected Access), the most dominating security mechanism in industry, is separated into two categories: WPA-personal or called WPA Pre-Share Key (WPA/PSK), and WPA-Enterprise or called WPA/802.1x.

In WPA-Personal, a pre-defined key is used for encryption during data transmission. WPA applies Temporal Key Integrity Protocol (TKIP) for data encryption while WPA2 applies AES. The WPA-Enterprise combines not only encryption but also authentication.

Since WEP has been proved vulnerable, you may consider using WPA for the most secure connection. You should select the appropriate security mechanism according to your needs. No matter which security suite you select, they all will enhance the over-the-air data protection and /or privacy on your wireless network. The VigorAP 960C is very flexible and can support multiple secure connections with both WEP and WPA at the same time.

WPS Introduction

WPS (Wi-Fi Protected Setup) provides easy procedure to make network connection between wireless station and wireless access point (VigorAP 960C) with the encryption of WPA and WPA2.



It is the simplest way to build connection between wireless network clients and VigorAP 960C. Users do not need to select any encryption mode and type any long encryption passphrase to setup a wireless client every time. He/she only needs to press a button on wireless client, and WPS will connect for client and VigorAP 960C automatically.

i Note:

Such function is available for the wireless station with WPS supported.

There are two methods to do network connection through WPS between AP and Stations: pressing the **Start PBC** button or using **PIN Code**.

On the side of VigorAP 960C series which served as an AP, press **WPS** button once on the front panel of VigorAP 960C or click **Start PBC** on web configuration interface. On the side of a station with network card installed, press **Start PBC** button of network card.

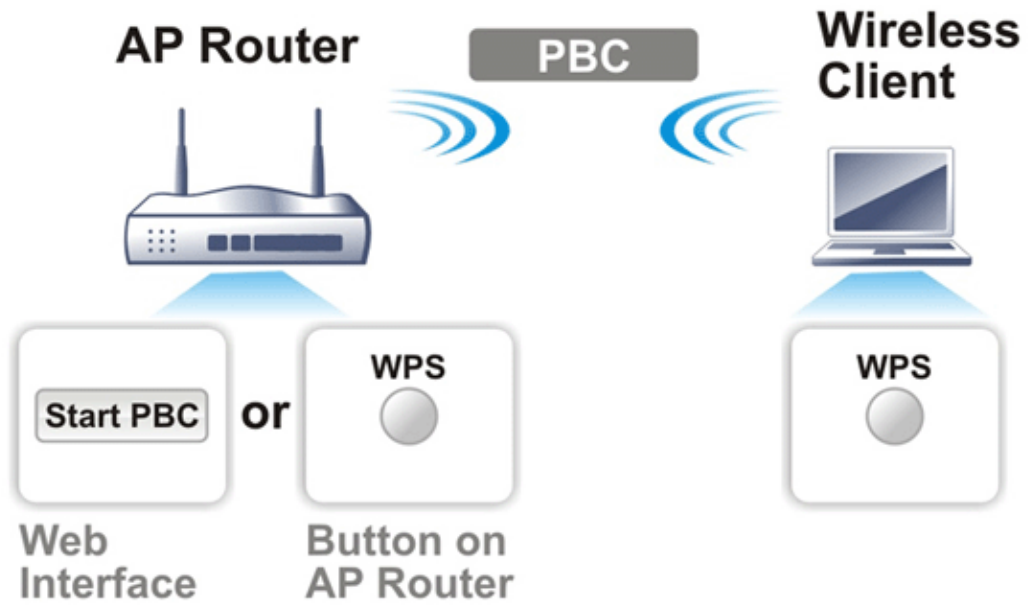

If you want to use PIN code, you have to know the PIN code specified in wireless client. Then provide the PIN code of the wireless client you wish to connect to the VigorAP 960C.

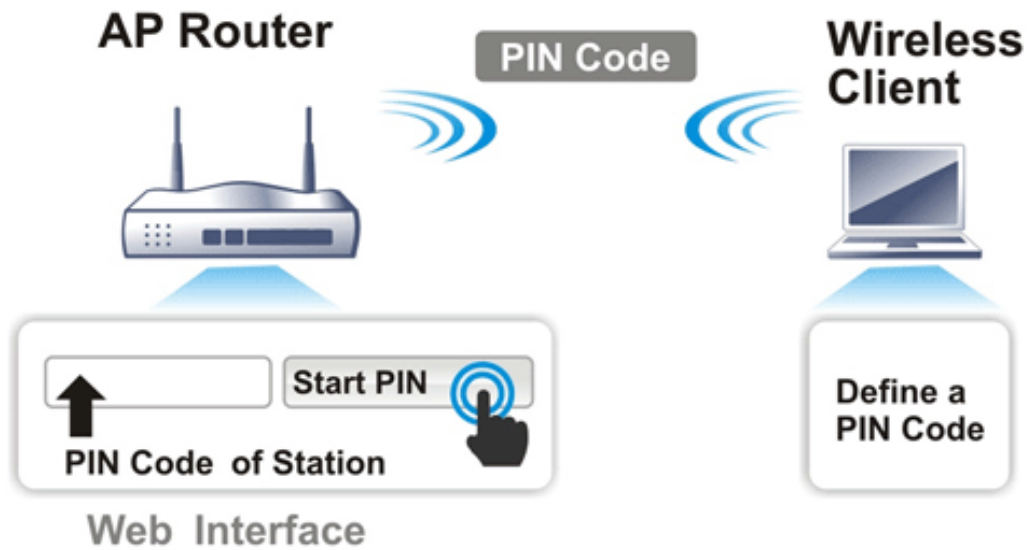

II-3 Wireless LAN (2.4GHz/5GHz) Settings for AP Mode

When you choose **AP** as the operation mode, the Wireless LAN menu items will include General Setup, Security, Access Control, WPS, Advanced Setting, AP Discovery, WDS AP Status, Airtime Fairness, Station Control, Roaming, Band Steering and Station List.

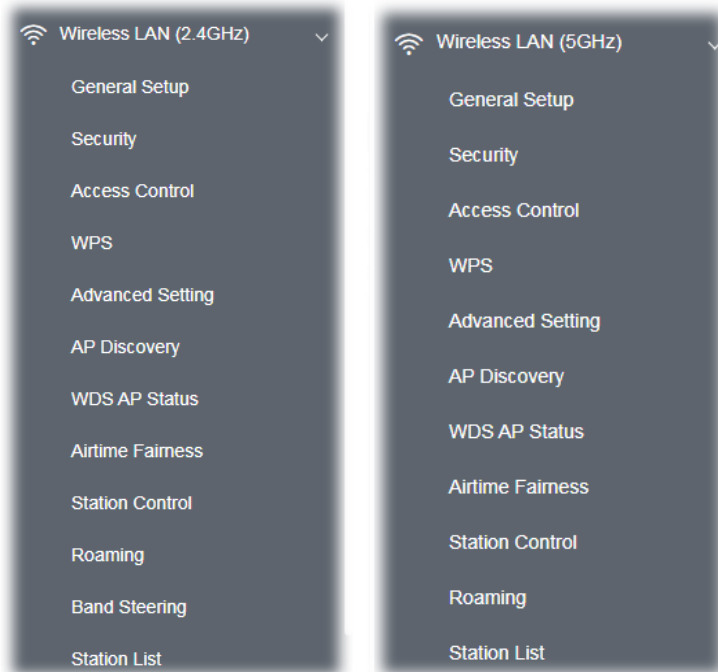

i Note:

Available settings for **Wireless LAN (2.4GHz)** and **Wireless LAN (5GHz)** are almost the same, except for Band Steering.

The following figure shows how VigorAP runs as AP (Access Point)

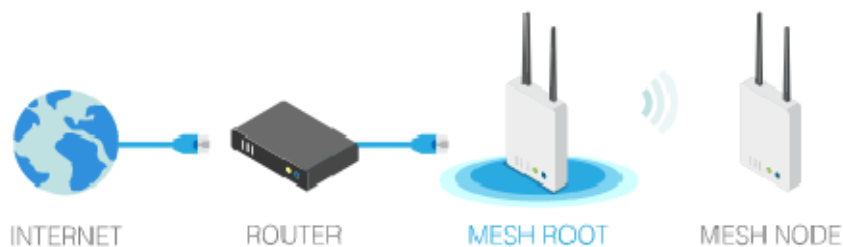

II-3-1 General Setup

By clicking the **General Setup**, a new web page will appear so that you could configure the SSID, the wireless channel and WDS settings. Please refer to the following figure for more information.

Wireless LAN (5GHz) >> General Setup

General Setting (IEEE 802.11)

Enable Wireless LAN

Enable Client Limit (3 ~ 128, default: 128)

Enable Client Limit per SSID (3 ~ 128, default: 128)

Mode :

Channel : (Active Channel: 36)

Details : 20/40MHz Ext Ch: 40 , 80MHz Center Ch: 42

| | Enable | Hide SSID | SSID | Isolate LAN | Isolate Member | VLAN ID (0:Untagged) |
|---|-------------------------------------|--------------------------|---------------------------------------------|--------------------------|--------------------------|--------------------------------|
| 1 | <input type="checkbox"/> | <input type="checkbox"/> | <input type="text" value="DrayTek-4275CC"/> | <input type="checkbox"/> | <input type="checkbox"/> | <input type="text" value="0"/> |
| 2 | <input checked="" type="checkbox"/> | <input type="checkbox"/> | <input type="text" value="mk_carrie"/> | <input type="checkbox"/> | <input type="checkbox"/> | <input type="text" value="0"/> |
| 3 | <input type="checkbox"/> | <input type="checkbox"/> | <input type="text"/> | <input type="checkbox"/> | <input type="checkbox"/> | <input type="text" value="0"/> |
| 4 | <input type="checkbox"/> | <input type="checkbox"/> | <input type="text"/> | <input type="checkbox"/> | <input type="checkbox"/> | <input type="text" value="0"/> |

Hide SSID: Prevent SSID from being scanned.
Isolate LAN: Wireless clients (stations) with the same SSID cannot access wired PCs on LAN.
Isolate Member: Wireless clients (stations) with the same SSID cannot access for each other.
Isolate Exception: Isolate Exception can be created by adding the MAC from [Device Object](#).
Note: To allow communication between clients with different SSIDs on different bands, disable the Isolate 2.4GHz and 5GHz bands option on [Advanced Setting](#).

WDS Settings (PHY Mode : HTMIX)

| | |
|--------------------------------------------------------------------------------------------------------------------------------------------------------------|-------------------------------------------------------------------------------------------------------------------------------------------------------------------------------------------------------------------------------------------------------------------------------------------------------------------------------------------------------------------------------------------------------------------------------------------------------------------------------------------------------------------------------------------------------------------------------------------------------------------|
| Security : <input checked="" type="radio"/> Disabled <input type="radio"/> TKIP <input type="radio"/> AES Key : <input type="text"/> | Peer MAC Address : 1. <input type="text"/> : <input type="text"/> : <input type="text"/> : <input type="text"/> : <input type="text"/> : <input type="text"/> 2. <input type="text"/> : <input type="text"/> : <input type="text"/> : <input type="text"/> : <input type="text"/> : <input type="text"/> 3. <input type="text"/> : <input type="text"/> : <input type="text"/> : <input type="text"/> : <input type="text"/> : <input type="text"/> 4. <input type="text"/> : <input type="text"/> : <input type="text"/> : <input type="text"/> : <input type="text"/> : <input type="text"/> |
|--------------------------------------------------------------------------------------------------------------------------------------------------------------|-------------------------------------------------------------------------------------------------------------------------------------------------------------------------------------------------------------------------------------------------------------------------------------------------------------------------------------------------------------------------------------------------------------------------------------------------------------------------------------------------------------------------------------------------------------------------------------------------------------------|

Note: Enter the configuration of APs which AP960C want to connect.
 Remote AP should always use LAN-A or SSID1 MAC address to connect AP960C WDS

Available for
5GHz Access
Point Mode

Available settings are explained as follows:

| Item | Description |
|----------------------------|-----------------------------------------------------------------------------------------------------------------------------------------|
| Enable Wireless LAN | Check the box to enable wireless function. |
| Enable Client Limit | Check the box to set the maximum number of wireless stations which try to connect Internet through Vigor device. The number you can set |

| | |
|--------------------------------------------|---------------------------------------------------------------------------------------------------------------------------------------------------------------------------------------------------------------------------------------------------------------------------------------------------------------------------------------------------------------------------------------------|
| | is from 3 to 128. |
| Enable Client Limit per SSID | Define the maximum number of wireless stations per SSID which try to connect to Internet through Vigor device. The number you can set is from 3 to 128. |
| Mode | At present, VigorAP 960C can connect to 11n only, Mixed (11b+11g), Mixed (11b+11g+11n), Mixed (11b+11g+11n+11ax), 11a Only, 11n Only(5G), Mixed (11a+11n), Mixed (11a+11n+11ac) and Mixed (11a+11n+11ac+11ax) stations simultaneously. Simply choose the default mode. |
| Channel | Means the channel of frequency of the wireless LAN. You may switch channel if the selected channel is under serious interference. If you have no idea of choosing the frequency, please select AutoSelect to let system determine for you. |
| Extension Channel (For 2.4GHz only) | With 802.11n, there is one option to double the bandwidth per channel. The available extension channel options will be varied according to the Channel selected above. Configure the extension channel you want. |
| Hide SSID | Check it to prevent from wireless sniffing and make it harder for unauthorized clients or STAs to join your wireless LAN. Depending on the wireless utility, the user may only see the information except SSID or just cannot see any thing about VigorAP 960C while site surveying. The system allows you to set four sets of SSID for different usage. |
| SSID | Set a name for VigorAP 960C to be identified. Default settings are DrayTek-LAN-A and DrayTek-LAN-B. When Enable 2 Subnet is enabled, you can specify subnet interface (LAN-A or LAN-B) for each SSID by using the drop down menu. |
| Isolate LAN | Check this box to isolate the wireless connection from LAN. It can make the wireless clients (stations) with remote-dial and LAN to LAN users not accessing for each other. |
| Isolate Member | Check this box to make the wireless clients (stations) with the same SSID not access for each other. |
| VLAN ID | Type the value for such SSID. Packets transferred from such SSID to LAN will be tagged with the number. If your network uses VLANs, you can assign the SSID to a VLAN on your network. Client devices that associate using the SSID are grouped into this VLAN. The VLAN ID range is from 3 to 4095. The VLAN ID is 0 by default, it means disabling the VLAN function for the SSID. |
| PHY Mode | Data will be transmitted via HTMIX mode. Each access point should be setup to the same Phy Mode for connecting with each other. |
| Security | Select WEP, TKIP or AES as the encryption algorithm. Type 8~63 ASCII characters, such as 012345678..(or 64 Hexadecimal digits leading by 0x, such as "0x321253abcde..."). |
| Peer MAC Address | Type the peer MAC address for the access point that VigorAP 960C connects to. |

After finishing this web page configuration, please click **OK** to save the settings.

II-3-2 Security

This page allows you to set security with different modes for SSID 1, 2, 3 and 4 respectively. After configuring the correct settings, please click **OK** to save and invoke it.

By clicking the **Security Settings**, a new web page will appear so that you could configure the settings.

Wireless LAN (2.4GHz) >> Security Settings

| SSID 1 | SSID 2 | SSID 3 | SSID 4 |
|------------------------------------------------------------|------------------------------------------------------------------------------------------------|----------------------------------|--------|
| SSID | DrayTek-4275CC | | |
| Mode | WPA2 Personal | | |
| Set up RADIUS Server if 802.1x is enabled. | | | |
| WPA | | | |
| WPA Algorithms | <input type="radio"/> TKIP <input checked="" type="radio"/> AES <input type="radio"/> TKIP/AES | | |
| Pass Phrase | <input type="password" value="••••••••"/> | | |
| Key Renewal Interval | <input type="text" value="3600"/> seconds | | |
| EAPOL Key Retry | <input checked="" type="radio"/> Enable <input type="radio"/> Disable | | |
| WEP | | | |
| <input type="radio"/> Key 1 : | <input type="password"/> | <input type="text" value="Hex"/> | |
| <input type="radio"/> Key 2 : | <input type="password"/> | <input type="text" value="Hex"/> | |
| <input type="radio"/> Key 3 : | <input type="password"/> | <input type="text" value="Hex"/> | |
| <input type="radio"/> Key 4 : | <input type="password"/> | <input type="text" value="Hex"/> | |

Available settings are explained as follows:

| Item | Description |
|-------------|---------------------------------------------------------------------------------------------------------------------------------------------------------------------------------------------------------------------------------------------------------------------------------------------------------------------------------------------------------------------------------------------------------------------------------------------------------------------------------------------------------------------------------------------------------------------------------------------------------------------------------------------------------------------------------------------------------------------------------------------------------------------------------------------------------|
| Mode | <p>There are several modes provided for you to choose.</p> <p><u>Below shows the modes with higher security:</u></p> <ul style="list-style-type: none"> WPA3 Personal, WPA3/WPA2 Personal, WPA2 Personal, WPA2/WPA Personal - Accepts only WPA clients and the encryption key should be entered in PSK. The WPA encrypts each frame transmitted from the radio using the key, which either PSK (Pre-Shared Key) entered manually in this field below or automatically negotiated via 802.1x authentication. WPA3 Enterprise, WPA3/WPA2 Enterprise, WPA2 Enterprise, WPA2/WPA Enterprise - The WPA encrypts each frame transmitted from the radio using the key, which either PSK (Pre-Shared Key) entered manually in this field below or |

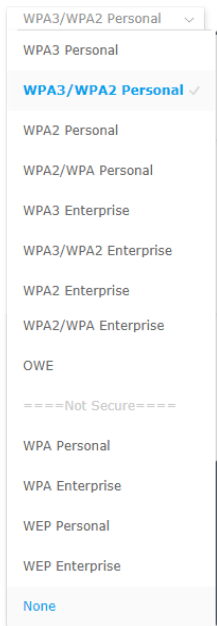

automatically negotiated via 802.1x authentication.

- **WPA2 Enterprise** - The WPA encrypts each frame transmitted from the radio using the key, which either PSK (Pre-Shared Key) entered manually in this field below or automatically negotiated via 802.1x authentication.
- **OWE** - WPA3 also introduces a new open and secure connection mode; "Opportunistic Wireless Encryption" (OWE). It allows the clients to connect without a password, ideal for hotspot networks, but the connection between each individual client is uniquely encrypted behind the scenes.

Below shows the modes with basic security:

- **WPA Personal** - Accepts only WPA clients and the encryption key should be entered in PSK. The WPA encrypts each frame transmitted from the radio using the key, which either PSK (Pre-Shared Key) entered manually in this field below or automatically negotiated via 802.1x authentication.
- **WPA Enterprise** - The WPA encrypts each frame transmitted from the radio using the key, which either PSK (Pre-Shared Key) entered manually in this field below or automatically negotiated via 802.1x authentication.
- **WEP Personal** - Accepts only WEP clients and the encryption key should be entered in WEP Key.
- **WEP Enterprise** - The built-in RADIUS client feature enables VigorAP 960C to assist the remote dial-in user or a wireless station and the RADIUS server in performing mutual authentication. It enables centralized remote access authentication for network management.
- **None** - The encryption mechanism is turned off.

| | |
|------------------------------------|----------------------------------------------------------------------------------------------------------------------------------------------------------------------------------------------------------------------------------------------------------------------------------------------------------------------------------------------------------------------------------------------------------------------------------------------------------------------------------------------------------------------------------------------------------------------------------------------------------------------------------|
| <p>WPA Algorithms</p> | <p>This feature is available for WPA3 Enterprise, WPA2 Enterprise, WPA Enterprise, WPA3 Personal, WPA2 Personal, WPA Personal, WPA3/WPA2 Personal, or WPA2/WPA Personal mode.</p> <p>Select TKIP, AES or TKIP/AES as the algorithm for WPA.</p> <p>Note that not all modes of Vigor router supports WPA3 mode. However, if the Vigor router supports WPA3 Personal/Enterprise security mode, the WPA algorithms will be set as AES.</p> |
| <p>Pass Phrase</p> | <p>Type 8~63 ASCII characters, such as 012345678..(or 64 Hexadecimal digits leading by 0x, such as "0x321253abcde..."). This feature is available for WPA Personal or WPA2 Personal or WPA2 / WPA Personal mode, WPA3 Personal or WPA3/WPA2 Personal.</p> |
| <p>Key Renewal Interval</p> | <p>WPA uses shared key for authentication to the network. However, normal network operations use a different encryption key that is randomly generated. This randomly generated key that is periodically replaced. Enter the renewal security time (seconds) in the column. Smaller interval leads to greater security but lower performance. Default is 3600 seconds. Set 0 to disable re-key. This feature is available for WPA3 Enterprise, WPA2 Enterprise, WPA Enterprise, WPA3 Personal, WPA2 Personal, WPA Personal, WPA3/WPA2 Enterprise, WPA2/WPA Enterprise, WPA3/WPA2 Personal, or WPA2/WPA Personal mode.</p> |
| <p>EAPOL Key Retry</p> | <p>EAPOL means Extensible Authentication Protocol over LAN.</p> <p>Click Enable to make sure that the key will be installed and used once in order to prevent key reinstallation attack.</p> |

Key 1 – Key 4

Four keys can be entered here, but only one key can be selected at a time. The format of WEP Key is restricted to 5 ASCII characters or 10 hexadecimal values in 64-bit encryption level, or restricted to 13 ASCII characters or 26 hexadecimal values in 128-bit encryption level. The allowed content is the ASCII characters from 33(!) to 126(~) except '#' and ','. Such feature is available for **WEP** mode.

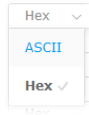

Click the link of **RADIUS Server** to access into the following page for more settings.

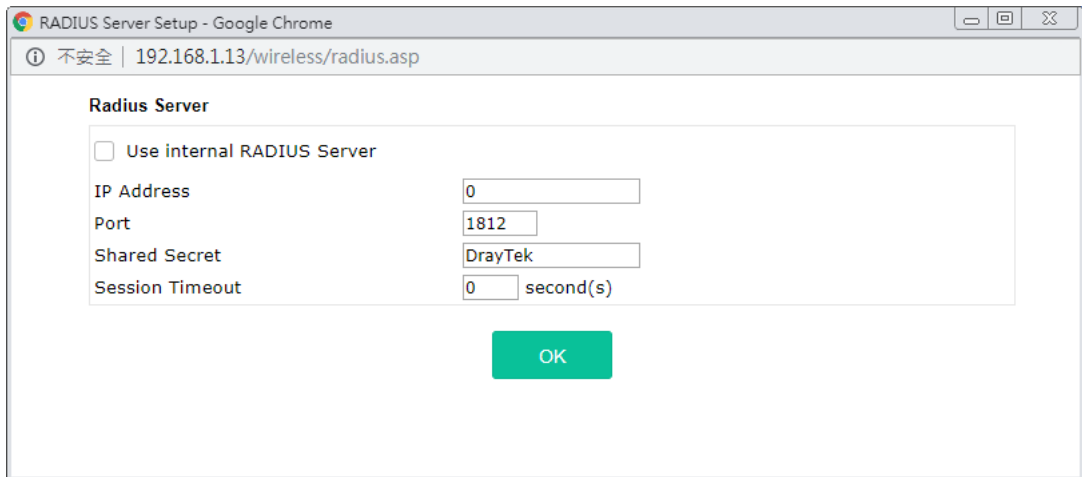

Available settings are explained as follows:

| Item | Description |
|-----------------------------------|--------------------------------------------------------------------------------------------------------------------------------------------------------------------------------------------------------------------------------------------------------------------------------------------------------------------------------------------------------------------------------------------------------------------------------------|
| Use internal RADIUS Server | There is a RADIUS server built in VigorAP 960C which is used to authenticate the wireless client connecting to the access point. Check this box to use the internal RADIUS server for wireless security. Besides, if you want to use the external RADIUS server for authentication, do not check this box. Please refer to the section, IV-1-1 RADIUS Server to configure settings for internal server of VigorAP 960C. |
| IP Address | Enter the IP address of external RADIUS server. |
| Port | The UDP port number that the external RADIUS server is using. The default value is 1812, based on RFC 2138. |
| Shared Secret | The external RADIUS server and client share a secret that is used to authenticate the messages sent between them. Both sides must be configured to use the same shared secret. |
| Session Timeout | Set the maximum time of service provided before re-authentication. Set to zero to perform another authentication immediately after the first authentication has successfully completed. (The unit is second.) |

After finishing this web page configuration, please click **OK** to save the settings.

II-3-3 Access Control

For additional security of wireless access, the **Access Control** facility allows you to restrict the network access right by controlling the wireless LAN MAC address of client. Only the valid MAC address that has been configured can access the wireless LAN interface. By clicking the **Access Control**, a new web page will appear, as depicted below, so that you could edit the clients' MAC addresses to control their access rights (deny or allow).

Wireless LAN (2.4GHz) >> Access Control

| SSID 1 | SSID 2 | SSID 3 | SSID 4 | | | | | | |
|---------------------------------------------------------------------------------------------------------------------------------------------------------------------------------------------------------------------------------------------------------------------------------------------------------------------------------------------------------------------------------------------------------------------------------------------------------------------------------------------------------------------------------------------------------------------------------------------------------------------------------------------------|-------------|----------------|--------|-------|-------------|----------------|--|--|--|
| SSID: DrayTek-4275CC Policy: Disable | | | | | | | | | |
| <p style="text-align: center;">MAC Address Filter</p> <table border="1"> <thead> <tr> <th>Index</th> <th>MAC Address</th> <th>access comment</th> </tr> </thead> <tbody> <tr> <td colspan="3" style="height: 100px;"></td> </tr> </tbody> </table> <p> <input type="radio"/> MAC <input checked="" type="radio"/> Object </p> <p> Device Group None or Device Object None </p> <p style="text-align: center;"> <input type="button" value="Add"/> Limit: 256 entries </p> <p style="text-align: center;"> <input type="button" value="OK"/> <input type="button" value="Cancel"/> </p> | | | | Index | MAC Address | access comment | | | |
| Index | MAC Address | access comment | | | | | | | |
| | | | | | | | | | |
| Backup ACL Cfg : <input type="button" value="Backup"/> Upload From File: <input type="button" value="Upload"/> <input type="text" value="..."/> <input type="button" value="Restore"/> | | | | | | | | | |

Available settings are explained as follows:

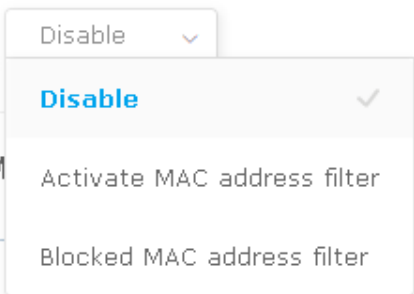
| Item | Description |
|---------------|-------------------------------------------------------------------------------------------------------------------------------------------------------------------------------------------------------------------------------------------------------------------------------------------------------------------------------------------------------------------------------------------------------------------------------------------------------------------------------|
| Policy | <p>Select to enable any one of the following policy or disable the policy. Choose Activate MAC address filter to type in the MAC addresses for other clients in the network manually. Choose Blocked MAC address filter, so that all of the devices with the MAC addresses listed on the MAC Address Filter table will be blocked and cannot access into VigorAP 960C.</p>  |

| | |
|---------------------------|------------------------------------------------------------------------------------------------------------------------------------------------------------------------------------------------------------------------------------------------------------------------------------------------------------------------------------------------------------------------------------------------------------------------------------------------|
| MAC Address Filter | Display all MAC addresses that are edited before. |
| MAC | <p>Client's MAC Address - Manually enter the MAC address of wireless client.</p> <p>Add - Add a new MAC address into the list.</p> <p>Delete - Delete the selected MAC address in the list.</p> <p>Edit - Edit the selected MAC address in the list.</p> |
| Object | <p>In addition to enter the MAC address of the device manually, you can</p> <p>Device Group - Select one of the existed device groups and click Add. All the devices belonging to the selected group will be shown on the MAC Address Filter table.</p> <p>Device Object - Select one of the existed device object and click Add. The MAC address of the device will be shown on the MAC Address Filter table.</p> |
| Cancel | Give up the access control set up. |
| Backup | Click it to store the settings (MAC addresses on MAC Address Filter table) on this page as a file. |
| Restore | Click it to restore the settings (MAC addresses on MAC Address Filter table) from an existed file. |

After finishing this web page configuration, please click **OK** to save the settings.

II-3-4 WPS

Open **Wireless LAN>>WPS** to configure the corresponding settings.

Wireless LAN (2.4GHz) >> WPS (Wi-Fi Protected Setup)

Enable WPS 

Wi-Fi Protected Setup Information

| | |
|------------------|----------------|
| WPS Configured | Yes |
| WPS SSID | DrayTek-4275CC |
| WPS Auth Mode | WPA2 Personal |
| WPS Encrypt Type | AES |

Device Configure

| | |
|------------------------------|---------------------------------------------------------------|
| Configure via Push Button | <input type="button" value="Start PBC"/> |
| Configure via Client PinCode | <input type="text"/> <input type="button" value="Start PIN"/> |

Status: Idle

Note: WPS can help your wireless client automatically connect to the Access point.

: WPS is Disabled.

: WPS is Enabled.

: Waiting for WPS requests from wireless clients.

Available settings are explained as follows:

| Item | Description |
|-------------------|---------------------------------------|
| Enable WPS | Check this box to enable WPS setting. |

| | |
|-------------------------------------|---------------------------------------------------------------------------------------------------------------------------------------------------------------------------------------------------------------------------------------------------------------------------------------------------------------------------------------------------|
| WPS Configured | Display related system information for WPS. If the wireless security (encryption) function of VigorAP 960C is properly configured, you can see 'Yes' message here. |
| WPS SSID | Display current selected SSID. |
| WPS Auth Mode | Display current authentication mode of the VigorAP 960C. Only WPA2/PSK and WPA/PSK support WPS. |
| WPS Encrypt Type | Display encryption mode (None, WEP, TKIP, AES, etc.) of VigorAP 960C. |
| Configure via Push Button | Click Start PBC to invoke Push-Button style WPS setup procedure. VigorAP 960C will wait for WPS requests from wireless clients about two minutes. Both ACT and 2.4G WLAN LEDs on VigorAP 960C will blink quickly when WPS is in progress. It will return to normal condition after two minutes. (You need to setup WPS within two minutes) |
| Configure via Client PinCode | Type the PIN code specified in wireless client you wish to connect, and click Start PIN button. Both ACT and 2.4G WLAN LEDs on VigorAP 960C will blink quickly when WPS is in progress. It will return to normal condition after two minutes. (You need to setup WPS within two minutes). |

II-3-5 Advanced Setting

This page is to determine which algorithm will be selected for wireless transmission rate.

Wireless LAN (2.4GHz) >> Advanced Setting

| | |
|--------------------------------|-----------------------------------------------------------------------------------------------------------------------------------------------------------------------------------------------------------------------------------------------------------------------------------------------------------------------------------------------------------------------|
| Channel Bandwidth | <input type="radio"/> 20 MHz <input checked="" type="radio"/> Auto 20/40 MHz <input type="radio"/> 40 MHz |
| Tx Power | <input checked="" type="radio"/> 100% <input type="radio"/> 80% <input type="radio"/> 60% <input type="radio"/> 30% <input type="radio"/> 20% <input type="radio"/> 10% |
| Fragment Length (256 - 2346) | <input type="text" value="2346"/> bytes |
| RTS Threshold (1 - 2347) | <input type="text" value="2347"/> bytes |
| Country Code | <input type="text"/> (Reference) |
| Auto Channel Filtered Out List | <input type="checkbox"/> 1 <input type="checkbox"/> 2 <input type="checkbox"/> 3 <input type="checkbox"/> 4 <input type="checkbox"/> 5 <input type="checkbox"/> 6 <input type="checkbox"/> 7 <input type="checkbox"/> 8 <input type="checkbox"/> 9 <input type="checkbox"/> 10 <input type="checkbox"/> 11 <input type="checkbox"/> 12 <input type="checkbox"/> 13 |
| IGMP Snooping | <input checked="" type="radio"/> Enable <input type="radio"/> Disable |
| Isolate 2.4GHz and 5GHz bands | <input checked="" type="radio"/> Enable <input type="radio"/> Disable |
| Isolate members with IP | <input type="radio"/> Enable <input checked="" type="radio"/> Disable |
| WMM Capable | <input checked="" type="radio"/> Enable <input type="radio"/> Disable |
| APSD Capable | <input type="radio"/> Enable <input checked="" type="radio"/> Disable |
| MAC Clone | <input type="radio"/> Enable <input checked="" type="radio"/> Disable <input type="text" value=""/> |
| MAC Clone: | Set the MAC address of SSIDs and the Wireless client. Please notice that the last byte of this MAC address must be a multiple of 8. |

Note: Fragment Length takes effect when mode is "11b Only" or "Mixed(11b+11g)".

Available settings are explained as follows:

| Item | Description |
|------------------------|--------------------------------------------------------------------------------------------------------------------------------------------------------------------------------------------------------------------------------------------------------------------------------------------------------------------------------------------------------------------------------------------------------------------------------------------------------------------------------------------------------------------------------------------------------------------------------------------------------|
| Channel Width | <p>20 MHz- The device will use 20MHz for data transmission and receiving between the AP and the stations.</p> <p>Auto 20/40 MHz-The AP will scan for nearby wireless AP, and then use 20MHz if the number of AP is more than 10, or use 40MHz if it's not.</p> <p>40 MHz- The device will use 40MHz for data transmission and receiving between the AP and the stations. It is for wireless LAN 2.4GHz only.</p> <p>Auto 20/40 /80 MHz (5GHz)- The device will use 20/40/80 MHz channel bandwidth for data transmission and receiving between the AP and the stations.</p> |
| Tx Power | The default setting is the maximum (100%). Lowering down the value may degrade range and throughput of wireless. |
| Fragment Length | Set the Fragment threshold of wireless radio. Do not modify default value if you don't know what it is, default value is 2346. |
| RTS Threshold | Minimize the collision (unit is bytes) between hidden stations to improve wireless performance. |

| | |
|---------------------------------------|-----------------------------------------------------------------------------------------------------------------------------------------------------------------------------------------------------------------------------------------------------------------------------------------------------------------------------------------------------------------------------------------------------------------------------------------------------------------------------------------------------------------------------------------------------------------------------------------------------------------------------------------------------------------------------------------------------------------------------|
| | Set the RTS threshold of wireless radio. Do not modify default value if you don't know what it is, default value is 2347. |
| Country Code | VigorAP broadcasts country codes by following the 802.11d standard. However, some wireless stations will detect / scan the country code to prevent conflict occurred. If conflict is detected, wireless station will be warned and is unable to make network connection. Therefore, changing the country code to ensure successful network connection will be necessary for some clients. |
| Auto Channel Filtered Out List | The selected wireless channels will be discarded if AutoSelect is selected as Channel selection mode in Wireless LAN>>General Setup . |
| IGMP Snooping | Click Enable to enable IGMP Snooping. Multicast traffic will be forwarded to ports that have members of that group. Disabling IGMP snooping will make multicast traffic treated in the same manner as broadcast traffic. |
| Isolate 2.4GHz and 5GHz bands | The default setting is "Enable". It means that the wireless client using 2.4GHz band is unable to connect to the wireless client with 5GHz band, and vice versa. For WLAN 2.4GHz and 5GHz set with the same SSID name: <ul style="list-style-type: none"> ● No matter such function is enabled or disabled, clients using WLAN 2.4GHz and 5GHz can communicate for each other if Isolate Member (in Wireless LAN>>General Setup) is NOT enabled for such SSID. ● Yet, if the function of Isolate Member (in Wireless LAN>>General Setup) is enabled for such SSID, clients using WLAN 2.4GHz and 5GHz will be unable to communicate with each other. |
| Isolate members with IP | The default setting is "Disable". If it is enabled, VigorAP will isolate different wireless clients according to their IP address(es). |
| WMM Capable | To apply WMM parameters for wireless data transmission, please click the Enable radio button. |
| APSD Capable | APSD (automatic power-save delivery) is an enhancement over the power-save mechanisms supported by Wi-Fi networks. It allows devices to take more time in sleeping state and consume less power to improve the performance by minimizing transmission latency. The default setting is Disable . |
| MAC Clone (for 2.4GHz only) | Click Enable and manually enter the MAC address of the device with SSID 1. The MAC address of other SSIDs will change based on this MAC address. |

After finishing this web page configuration, please click **OK** to save the settings.

II-3-6 AP Discovery

VigorAP 960C can scan all regulatory channels and find working APs in the neighborhood. Based on the scanning result, users will know which channel is clean for usage. Also, it can be used to facilitate finding an AP for a WDS link. Notice that during the scanning process (about 5 seconds), no client is allowed to connect to VigorAP.

This page is used to scan the existence of the APs on the wireless LAN. Please click **Scan** to discover all the connected APs.

Wireless LAN (5GHz) >> Access Point Discovery

Access Point List

| Select | Index | SSID | BSSID | RSSI | Channel | Encryption | Authentication | Mode | Ch. Width |
|-----------------------|-------|---------------|-------------------|-------------|---------|------------|---------------------|----------|-----------|
| <input type="radio"/> | 1 | | 00:1d:aa:63:2c:11 | 55%(-68dbm) | 36 | AES | UNKNOWN | 11a/n/ac | 80 |
| <input type="radio"/> | 2 | DrayTek_5G | 00:1d:aa:60:b3:d2 | 37%(-75dbm) | 36 | TKIP/AES | Mixed(WPA+WPA2)/PSK | 11a/n/ac | 80 |
| <input type="radio"/> | 3 | DrayTek06C | 00:1d:aa:57:5d:39 | 20%(-82dbm) | 36 | TKIP/AES | Mixed(WPA+WPA2)/PSK | 11a | 20 |
| <input type="radio"/> | 4 | DrayTek06C | 00:1d:aa:04:f0:6d | 34%(-76dbm) | 36 | AES | WPA2/PSK | 11a/n/ac | 80 |
| <input type="radio"/> | 5 | DrayTek_5G | 00:1d:aa:be:fd:8a | 29%(-78dbm) | 36 | TKIP/AES | Mixed(WPA+WPA2)/PSK | 11a/n | 20 |
| <input type="radio"/> | 6 | guests | 06:1d:aa:04:f0:dd | 42%(-73dbm) | 36 | TKIP/AES | Mixed(WPA+WPA2)/PSK | 11a/n/ac | 80 |
| <input type="radio"/> | 7 | DrayTek06C | 00:50:7f:f1:91:16 | 15%(-84dbm) | 36 | AES | WPA2/PSK | 11a/n/ac | 80 |
| <input type="radio"/> | 8 | staffs_5G | 00:50:7f:f1:91:ec | 1%(-95dbm) | 36 | AES | UNKNOWN | 11a/n/ac | 80 |
| <input type="radio"/> | 9 | DrayTek_5G | 00:1d:aa:00:00:00 | 76%(-60dbm) | 36 | TKIP/AES | Mixed(WPA+WPA2)/PSK | 11a/n/ac | 80 |
| <input type="radio"/> | 10 | | 06:1d:aa:63:2c:11 | 55%(-68dbm) | 36 | TKIP/AES | Mixed(WPA+WPA2)/PSK | 11a/n/ac | 80 |
| <input type="radio"/> | 11 | | 00:1d:aa:df:cf:b2 | 1%(-90dbm) | 36 | TKIP/AES | Mixed(WPA+WPA2)/PSK | 11a/n/ac | 80 |
| <input type="radio"/> | 12 | rd8rd8rd8 | 00:1d:aa:7e:87:be | 1%(-95dbm) | 36 | TKIP/AES | Mixed(WPA+WPA2)/PSK | 11a/n | 40 |
| <input type="radio"/> | 13 | | 12:1d:aa:04:f0:dd | 39%(-74dbm) | 36 | AES | WPA2/PSK | 11a/n/ac | 80 |
| <input type="radio"/> | 14 | staffs_5F5... | 00:1d:aa:3f:4f:87 | 1%(-96dbm) | 36 | AES | Mixed(WPA+WPA2)/PSK | 11a/n/ac | 80 |
| <input type="radio"/> | 15 | | 12:1d:aa:57:5d:39 | 20%(-82dbm) | 36 | AES | WPA2/PSK | 11a/n/ac | 80 |
| <input type="radio"/> | 16 | | 12:1d:aa:04:f0:6d | 37%(-75dbm) | 36 | AES | WPA2/PSK | 11a/n/ac | 80 |
| <input type="radio"/> | 17 | DrayTek_5G | 00:1d:aa:41:df:18 | 1%(-90dbm) | 36 | TKIP/AES | Mixed(WPA+WPA2)/PSK | 11a/n/ac | 80 |
| <input type="radio"/> | 18 | DrayTek_5G | 00:1d:aa:95:b6:f0 | 1%(-96dbm) | 36 | NONE | OPEN | 11a/n/ac | 80 |
| <input type="radio"/> | 19 | | 12:1d:aa:63:2c:11 | 55%(-68dbm) | 36 | AES | WPA2/PSK | 11a/n/ac | 80 |
| <input type="radio"/> | 20 | DrayTek_5G | 00:1d:aa:cb:a3:12 | 37%(-75dbm) | 36 | TKIP/AES | Mixed(WPA+WPA2)/PSK | 11a/n | 40 |
| <input type="radio"/> | 21 | | 12:50:7f:f1:91:ec | 1%(-95dbm) | 36 | AES | WPA2/PSK | 11a/n/ac | 80 |
| <input type="radio"/> | 22 | FAE-Wendy-... | 00:1d:aa:f0:6d:f2 | 1%(-96dbm) | 36 | AES | WPA2/PSK | 11a/n/ac | 80 |
| <input type="radio"/> | 23 | DrayTek_5G | 00:1d:aa:41:df:78 | 1%(-96dbm) | 36 | TKIP/AES | Mixed(WPA+WPA2)/PSK | 11a/n/ac | 80 |

Scan

See [Channel Interference](#)

Note: During the scanning process (about 5 seconds), no station is allowed to connect with the AP.

AP's MAC Address : : : : :

AP's SSID

Add to [WDS Settings](#):

Each item is explained as follows:

| Item | Description |
|---------------------------|-------------------------------------------------------------------------------------------------------------------|
| SSID | Display the SSID of the AP scanned by VigorAP 960C. |
| BSSID | Display the MAC address of the AP scanned by VigorAP 960C. |
| RSSI | Display the signal strength of the access point. RSSI is the abbreviation of Received Signal Strength Indication. |
| Channel | Display the wireless channel used for the AP that is scanned by VigorAP 960C. |
| Encryption | Display the encryption mode for the scanned AP. |
| Authentication | Display the authentication type that the scanned AP applied. |
| Mode | Display the wireless connection mode that the scanned AP used. |
| Ch. Width | Display the channel width that the scanned AP used. |
| Scan | It is used to discover all the connected AP. The results will be shown on the box above this button |
| AP's MAC Address / | Display the MAC address and SSID of the AP selected from the Access |

| | |
|------------------|----------------------------------------------------------------------------------------------------------------------------------|
| AP's SSID | Point. |
| Add | Click it to add the AP selected from the Access Point List (with the same channel width) to the WDS Settings as peer' s setting. |

II-3-7 WDS AP Status

VigorAP 960C can display the status such as MAC address, physical mode, power save and bandwidth for the working AP connected with WDS. Click **Refresh** to get the newest information.

Wireless LAN (5GHz) >> WDS AP Status

WDS AP List

| AID | MAC Address | 802.11 Physical Mode | Power Save | Bandwidth |
|-----|-------------|----------------------|------------|-----------|
|-----|-------------|----------------------|------------|-----------|

Refresh

II-3-8 Airtime Fairness

Airtime fairness is essential in wireless networks that must support critical enterprise applications.

Most of the applications are either symmetric or require more downlink than uplink capacity; telephony and email send the same amount of data in each direction, while video streaming and web surfing involve more traffic sent from access points to clients than the other way around. This is essential for ensuring predictable performance and quality-of-service, as well as allowing 802.11n and legacy clients to coexist on the same network. Without airtime fairness, offices using mixed mode networks risk having legacy clients slow down the entire network or letting the fastest client(s) crowd out other users.

With airtime fairness, every client at a given quality-of-service level has equal access to the network's airtime.

The wireless channel can be accessed by only one wireless station at the same time.

The principle behind the IEEE802.11 channel access mechanisms is that each station has **equal probability** to access the channel. When wireless stations have similar data rate, this principle leads to a fair result. In this case, stations get similar channel access time which is called airtime.

However, when stations have various data rate (e.g., 11g, 11n), the result is not fair. The slow stations (11g) work in their slow data rate and occupy too much airtime, whereas the fast stations (11n) become much slower.

Take the following figure as an example, both Station A(11g) and Station B(11n) transmit data packets through VigorAP 960C. Although they have equal probability to access the wireless channel, Station B(11n) gets only a little airtime and waits too much because Station A(11g) spends longer time to send one packet. In other words, Station B(fast rate) is obstructed by Station A(slow rate).

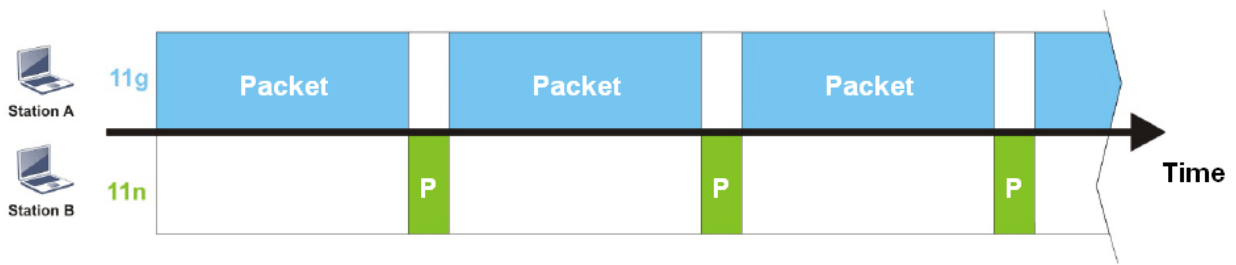

To improve this problem, Hardware-Based Airtime Fairness (ATF) is added for VigorAP 1060C. Basic Mode of ATF tries to assign equal airtime to each station (A/B). In the following figure, Station B (11n) has a higher probability to send data packets than Station A(11g). In this way, Station B (fast rate) gets fair airtime and its speed is not limited by Station A(slow rate).

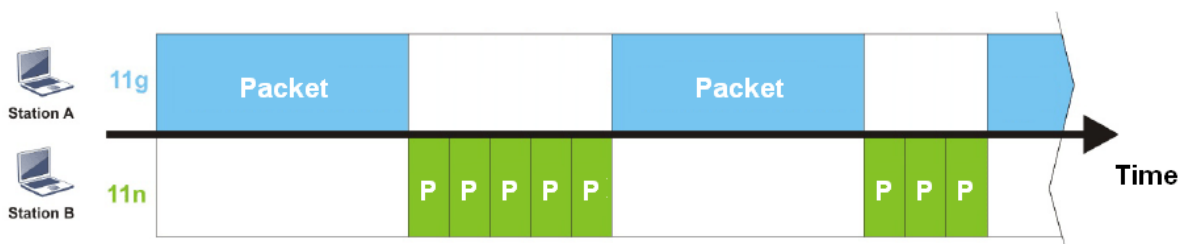

Wireless LAN (2.4GHz) >> Airtime Fairness

ATF Mode Basic Advanced Disable

Advanced ATF

[Display Client Airtime List](#)

| | | |
|-------|----------------------------------|---------------------------|
| SSID1 | <input type="text" value="100"/> | %airtime (Range: 0 ~ 100) |
| SSID2 | <input type="text" value="0"/> | %airtime (Range: 0 ~ 100) |
| SSID3 | <input type="text" value="0"/> | %airtime (Range: 0 ~ 100) |
| SSID4 | <input type="text" value="0"/> | %airtime (Range: 0 ~ 100) |

- Note:**
1. Airtime is the time where a wireless station occupies the wireless channel.
 2. Basic ATF: (1) Equal airtime allocation (2) Unused airtime redistribution.
 3. Advanced ATF: (1) SSID-based airtime allocation (2) Unused airtime redistribution.
 4. SSID-based airtime allocation: Allocate a percentage of available airtime to an SSID, and stations within the SSID share equal airtime.
 5. Equal airtime allocation: Stations get equal airtime.
 6. Unused airtime redistribution: Share the unused bandwidth from idle stations to active stations.
 7. Client num exceeds 50 will reduce the accuracy of the airtime fairness function.
 8. If SSID is disabled, the corresponding airtime value will be set to 0%.

Available settings are explained as follows:

| Item | Description |
|-----------------|---------------------------------------------------------------------------------------------------------------------------------------------------------------------------------------------------------------------------|
| ATF Mode | <p>Basic - Select to enable the basic airtime fairness settings.</p> <p>Advanced - Select to enable the advanced airtime fairness settings.</p> <p>Disable - Select to disable the ATF function.</p> |

| | |
|------------------------------------|----------------------------------------------------------------------------------------------------------------------------------------------------------------------------------------------------------------------------------------------------------|
| Advanced ATF | It is SSID-based airtime allocation. The downstream or upstream from FTP, HTTP or some P2P applications will occupy large of bandwidth and affect the applications for other programs. Adjust the value (0 ~ 100) of airtime bandwidth for each SSID. |
| Display Client Airtime List | Click to get a table of current clients which share the bandwidth via airtime fairness. |

After finishing this web page configuration, please click **OK** to save the settings.

II-3-9 Station Control

Station Control is used to specify the duration for the wireless client to connect and reconnect VigorAP. If such function is not enabled, the wireless client can connect VigorAP until it shuts down.

Such feature is especially useful for free Wi-Fi service. For example, a coffee shop offers free Wi-Fi service for its guests for one hour every day. Then, the connection time can be set as "1 hour" and reconnection time can be set as "1 day". Thus, the guest can finish his job within one hour and will not occupy the wireless network for a long time.

i Note:

Up to 300 Wireless Station records are supported by VigorAP.

Wireless LAN (2.4GHz) >> Station Control

| SSID 1 | SSID 2 | SSID 3 | SSID 4 |
|--------------------------------------------------|--------------------------|--------|--------|
| SSID | DrayTek-4275CC | | |
| Enable | <input type="checkbox"/> | | |
| Connection Time | 1 hour | | |
| Reconnection Time | 1 day | | |
| Display All Station Control List | | | |

Note: Once the feature is enabled, the connection time quota will apply to each wireless client (identified by MAC address).

OK Cancel

Available settings are explained as follows:

| Item | Description |
|--------------------------------------------|--------------------------------------------------------------------------------------------------------------------------------------------------------------------------------------|
| SSID | Display the SSID that the wireless station will use it to connect with Vigor router. |
| Enable | Check the box to enable the station control function. |
| Connection Time / Reconnection Time | Use the drop down list to choose the duration for the wireless client connecting /reconnecting to Vigor device. Or, type the duration manually when you choose User defined . |
| Display All Station Control List | All the wireless stations connecting to Vigor router by using such SSID will be listed on Station Control List. |

After finishing all the settings here, please click **OK** to save the configuration.

II-3-10 Roaming

The network signal for a single wireless access point might be limited by its coverage range. Therefore, if you want to expand the wireless network in a large exhibition with a quick method, you can install multiple access points with enabling the Roaming feature for each AP to reach the purpose of expanding wireless signals seamlessly.

These access points connecting for each other shall be verified by pre-authentication. This page allows you to enable the roaming feature and the pre-authentication.

Wireless LAN (5GHz) >> Roaming

AP-assisted Client Roaming Parameters

Minimum Basic Rate 6 Mbps

Disable RSSI Requirement

Strictly Minimum RSSI -73 dBm (42 %) (Default: -73)

Minimum RSSI -66 dBm (50 %) (Default: -66)
with Adjacent AP RSSI over 5 dB (Default: 5)

Fast Roaming(WPA2/802.1x)

Enable

PMK Caching : Cache Period 10 minutes (10 ~ 600, Default: 10)
Pre-Authentication

Available settings are explained as follows:

| Item | Description |
|----------------------------------------------|--------------------------------------------------------------------------------------------------------------------------------------------------------------------------------------------------------------------------------------------------------------------------------------------------------------------------------------------------------------------------------------------------------------------------------------------------------------------------------------------------------------------------------------------------------------------------------------------------------------------------------------------------------------------------------------------------------------------------------------------------------------------------------------------------------------------------------------------------------------------------------------------------------------------------------------------------------------------------------------------------------------------------------------------------------------------------------------------------------------------------------------------------------------------------------------------------------------------|
| AP-assisted Client Roaming Parameters | <p>When the link rate of wireless station is too low or the signal received by the wireless station is too worse, VigorAP 960C will automatically detect (based on the link rate and RSSI requirement) and cut off the network connection for that wireless station to assist it to connect another Wireless AP to get better signal.</p> <p>Minimum Basic Rate – Check the box to use the drop down list to specify a basic rate (Mbps). When the link rate of the wireless station is below such value, VigorAP 960C will terminate the network connection for that wireless station.</p> <p>Disable RSSI Requirement - If it is selected, VigorAP will not terminate the network connection based on RSSI.</p> <p>Strictly Minimum RSSI - VigorAP uses RSSI (received signal strength indicator) to decide to terminate the network connection of wireless station. When the signal strength is below the value (dBm) set here, VigorAP 960C will terminate the network connection for that wireless station.</p> <p>Minimum RSSI - When the signal strength of the wireless station is below the value (dBm) set here and adjacent AP (must be DrayTek AP</p> |

| | |
|------------------------------------------|------------------------------------------------------------------------------------------------------------------------------------------------------------------------------------------------------------------------------------------------------------------------------------------------------------------------------------------------------------------------------------------------------------------------------------------------------------------------------------------------------------------------------------------------------------------------------------------------------------------------------------------------------------------------------------------------------------------------------------------------------------------------------------------------------------------|
| | <p>and support such feature too) with higher signal strength value (defined in the field of With Adjacent AP RSSI over) is detected by VigorAP 960C, VigorAP 960C will terminate the network connection for that wireless station. Later, the wireless station can connect to the adjacent AP (with better RSSI).</p> <ul style="list-style-type: none"> ● With Adjacent AP RSSI over – Specify a value as a threshold. |
| <p>Fast Roaming (WPA2/802.1x)</p> | <p>Enable – Check the box to enable fast roaming configuration.</p> <p>PMK Caching - Set the expire time of WPA2 PMK (Pairwise master key) cache. PMK Cache manages the list from the BSSIDs in the associated SSID with which it has pre-authenticated. Such feature is available for WPA2/802.1 mode.</p> <p>Pre-Authentication - Enables a station to authenticate to multiple APs for roaming securer and faster. With the pre-authentication procedure defined in IEEE 802.11i specification, the pre-four-way-handshake can reduce handoff delay perceivable by a mobile node. It makes roaming faster and more secure. (Only valid in WPA2)</p> <p>Enable - Enable IEEE 802.1X Pre-Authentication.</p> <p>Disable - Disable IEEE 802.1X Pre-Authentication.</p> |

After finishing this web page configuration, please click **OK** to save the settings.

II-3-11 Band Steering (for Wireless LAN (2.4GHz))

Band Steering detects if the wireless clients are capable of 5GHz operation, and steers them to that frequency. It helps to leave 2.4GHz band available for legacy clients, and improves users experience by reducing channel utilization.

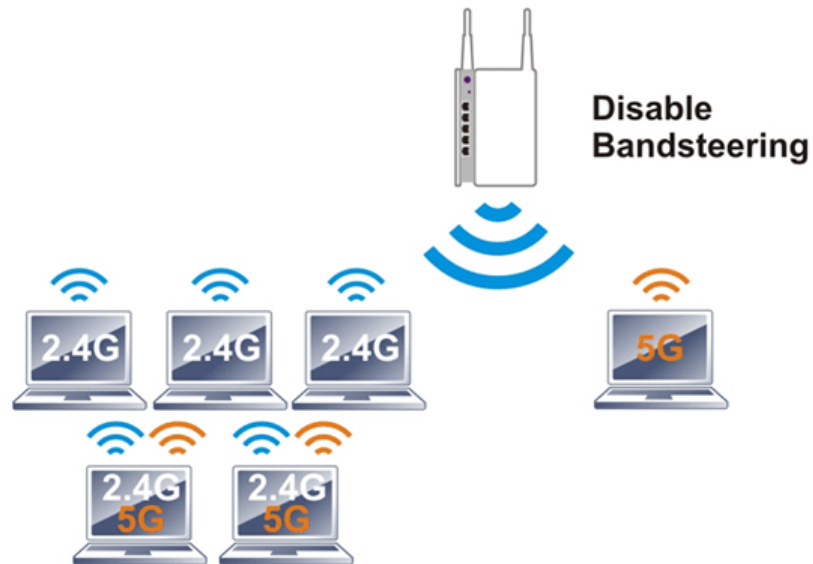

If dual-band is detected, the AP will let the wireless client connect to less congested wireless LAN, such as 5GHz to prevent from network congestion.

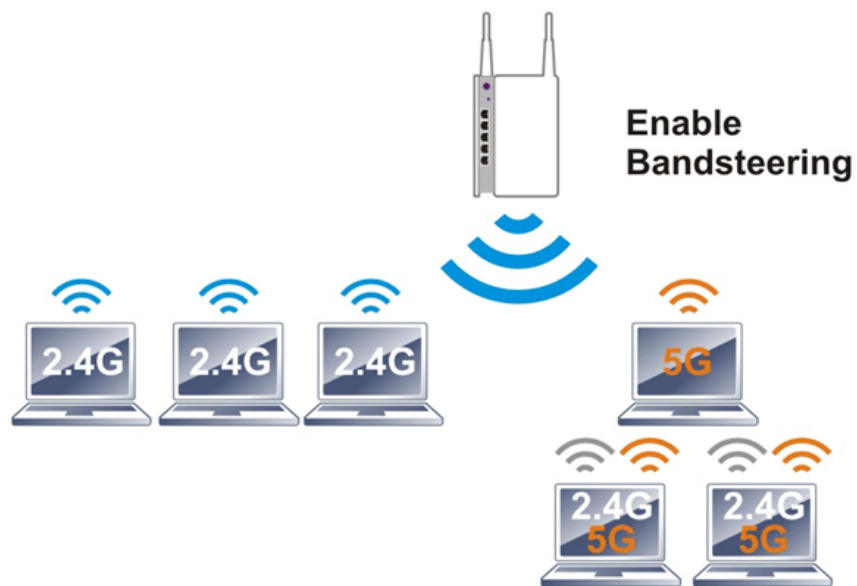

i Note:

To make Band Steering work successfully, SSID and security on 2.4GHz also MUST be broadcasted on 5GHz.

Open **Wireless LAN (2.4GHz)>>Band Steering** to get the following web page:

Wireless LAN (2.4GHz) >> Band Steering

Enable Band Steering

Check Time for WLAN Client 5G Capability seconds (1 ~ 60, Default: 15)

Wait Full Time to Check 5G Capability

5GHz Minimum RSSI dBm (29 %) (Default: -78)

(Only do band steering when 5GHz signal is better than Minimum RSSI)

Overloaded

2.4GHz Utilization Overload Threshold % (Default: 70)

5GHz Utilization Overload Threshold % (Default: 70)

(Only do band steering when 2.4GHz utilization is overloaded and 5GHz utilization is not)

Note: Please setup at least one pair of 2.4GHz and 5GHz Wireless LAN with the same SSID and security.

Available settings are explained as follows:

| Item | Description |
|-----------------------------|----------------------------------------------------------------------------------------------------------------------------------------------------------------------------------------------------------------------------------------------------------------------------------------------------------------------------------------------------------------------------------------------------------------------------------------------------------------------------------------------------------------------------------------------------------------------------------------------------------------------------------------------------------------------------------------------------------------------------------------------------------------------------------------------------------------------------------------------------------------------------------------------------------------------------------------------------------------------------------------------------------------------------------------------------------------------------------------------------------------------------------------------------------------------------------------------------------------------------------------------------------------------------------------------------------------------------------------------------------------------------------------------------------------------------------------------------------------------------------------------------------------------------------------------------------------------------------------------------------------------------------------------------------------------------------------------------------------------------------------------------------------------------|
| Enable Band Steering | <p>If it is enabled, VigorAP 960C will detect if the wireless client is capable of dual-band or not within the time limit.</p> <p>Check Time.... – If the wireless station does not have the capability of 5GHz network connection, the system shall wait and check for several seconds (15 seconds, in default) to make the 2.4GHz network connection. Specify the time limit for VigorAP to detect the wireless client.</p> <p>Wait Full Time to Check 5G Capability – If enabled, the client trying to connect to wireless network 2.4G has to wait for a few seconds (defined in Check Time... above) to check if the connecting device has the 5G capability. If no 5G capability, the client will be directed to the wireless 2.4G network.</p> <p>5GHz Minimum RSSI – The wireless station has the capability of 5GHz network connection, yet the signal performance might not be satisfied. Therefore, when the signal strength is below the value set here while the wireless station connecting to VigorAP, VigorAP will allow the client to connect to 2.4GHz network.</p> <p>Overloaded – If it is enabled, VigorAP will activate the band steering according to the conditions set below.</p> <ul style="list-style-type: none"> ● 2.4GHz Utilization Overload Threshold – The default setting is 70%. It can define the network congestion for 2.4GHz. ● 5GHz Utilization Overload Threshold – The default setting is 70%. It can define the network congestion for 5GHz. <p>When the utilization of 2.4GHz is higher than the specified threshold and the utilization of 5GHz is lower than the specified threshold, VigorAP will steer the client to connect to 5GHz network.</p> |

After finishing this web page configuration, please click **OK** to save the settings.

Below shows how Band Steering works.

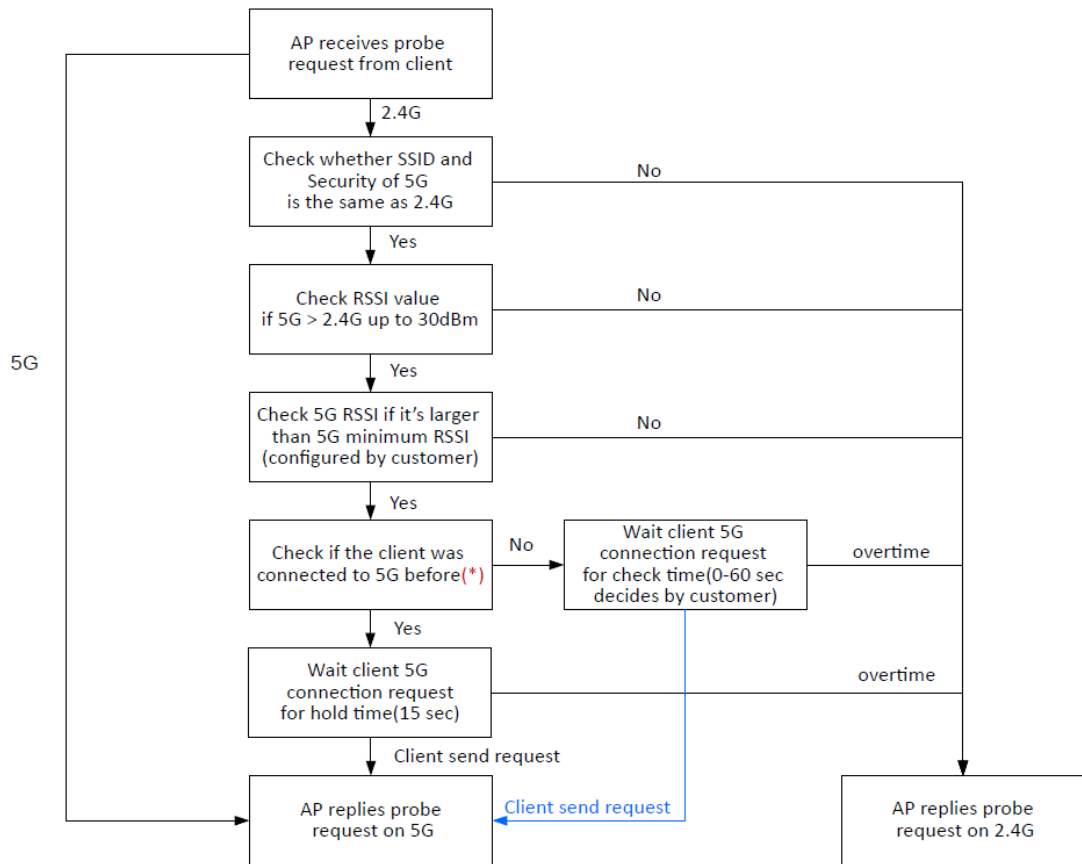

* AP will clear the 5G history station list every 2.5 mins.

How to Use Band Steering?

1. Open **Wireless LAN(2.4GHz)>>Band Steering**.
2. Check the box of **Enable Band Steering** and use the default value (15) for check time setting.

Wireless LAN (2.4GHz) >> Band Steering

Enable **Band Steering**

Check Time for WLAN Client 5G Capability seconds (1 ~ 60, Default: 15)

Wait Full Time to Check 5G Capability

3. Click **OK** to save the settings.
4. Open **Wireless LAN (2.4GHz)>>General Setup**, **Wireless LAN (5GHz)>>General Setup**, and **Wireless LAN (5GHz-2) >>General Setup**. Configure SSID as *ap960c-BandSteering* for these pages. Click **OK** to save the settings.

Wireless LAN (2.4GHz) >> General Setup

General Setting (IEEE 802.11)

Enable Wireless LAN

Enable Client Limit (3 ~ 128, default: 128)

Enable Client Limit per SSID (3 ~ 128, default: 128)

Mode :

Channel :

Extension Channel :

| | Enable | Hide SSID | SSID | Isolate LAN | Isolate Member | VLAN ID |
|---|-------------------------------------|--------------------------|----------------------|--------------------------|--------------------------|--------------------------------|
| 1 | <input type="checkbox"/> | <input type="checkbox"/> | ap960 c-BandSteering | <input type="checkbox"/> | <input type="checkbox"/> | <input type="text" value="0"/> |
| 2 | <input checked="" type="checkbox"/> | <input type="checkbox"/> | mk_carrie | <input type="checkbox"/> | <input type="checkbox"/> | <input type="text" value="0"/> |
| 3 | <input type="checkbox"/> | <input type="checkbox"/> | | <input type="checkbox"/> | <input type="checkbox"/> | <input type="text" value="0"/> |

Wireless LAN (5GHz) >> General Setup

General Setting (IEEE 802.11)

Enable Wireless LAN

Enable Client Limit (3 ~ 128, default: 128)

Enable Client Limit per SSID (3 ~ 128, default: 128)

Mode :

Channel : (Active Channel: 36)

Details : 20/40MHz Ext Ch: 40 , 80MHz Center Ch: 42

| | Enable | Hide SSID | SSID | Isolate LAN | Isolate Member | VLAN ID |
|---|-------------------------------------|--------------------------|----------------------|--------------------------|--------------------------|--------------------------------|
| 1 | <input type="checkbox"/> | <input type="checkbox"/> | ap960 c-BandSteering | <input type="checkbox"/> | <input type="checkbox"/> | <input type="text" value="0"/> |
| 2 | <input checked="" type="checkbox"/> | <input type="checkbox"/> | mk_carrie | <input type="checkbox"/> | <input type="checkbox"/> | <input type="text" value="0"/> |

Same value for 2.4GHz and 5GHz

5. Open **Wireless LAN (2.4GHz)>>Security** and **Wireless LAN (5GHz)>>Security**. Configure Security as 12345678 for both pages. Click **OK** to save the settings.

Wireless LAN (2.4GHz) >> Security Settings

| SSID 1 | SSID 2 | SSID 3 | SSID 4 |
|------------------------------------------------------------|------------------------------------------------------------------------------------------------|--------|--------|
| SSID | ap960c-BandSteering | | |
| Mode | WPA2 Personal | | |
| Set up RADIUS Server if 802.1x is enabled. | | | |
| WPA | | | |
| WPA Algorithms | <input type="radio"/> TKIP <input checked="" type="radio"/> AES <input type="radio"/> TKIP/AES | | |
| Pass Phrase | [Redacted] | | |
| Key Renewal Interval | 3600 seconds | | |
| EAPOL Key Retry | <input checked="" type="radio"/> Enable <input type="radio"/> Disable | | |
| WEP | | | |

Wireless LAN (5GHz) >> Security Settings

| SSID 1 | SSID 2 | SSID 3 | SSID 4 |
|------------------------------------------------------------|------------------------------------------------------------------------------------------------|--------|--------|
| SSID | ap960c-BandSteering | | |
| Mode | WPA2 Personal | | |
| Set up RADIUS Server if 802.1x is enabled. | | | |
| WPA | | | |
| WPA Algorithms | <input type="radio"/> TKIP <input checked="" type="radio"/> AES <input type="radio"/> TKIP/AES | | |
| Pass Phrase | [Redacted] | | |
| Key Renewal Interval | 3600 seconds | | |
| EAPOL Key Retry | <input checked="" type="radio"/> Enable <input type="radio"/> Disable | | |
| WEP | | | |

Same value for 2.4GHz and 5GHz

6. Now, VigorAP 960C will let the wireless clients connect to less congested wireless LAN, such as 5GHz to prevent from network congestion.

II-3-12 Station List

Station List provides the information related to the number of clients connecting to VigorAP, used bandwidth and the statistics of the AP device OS. Besides, users can create access control policies, device objects and set black & white list for

II-3-12-1 Connected Number

This page lists the graph for the number of wireless stations connected to this Access Point with different time phases.

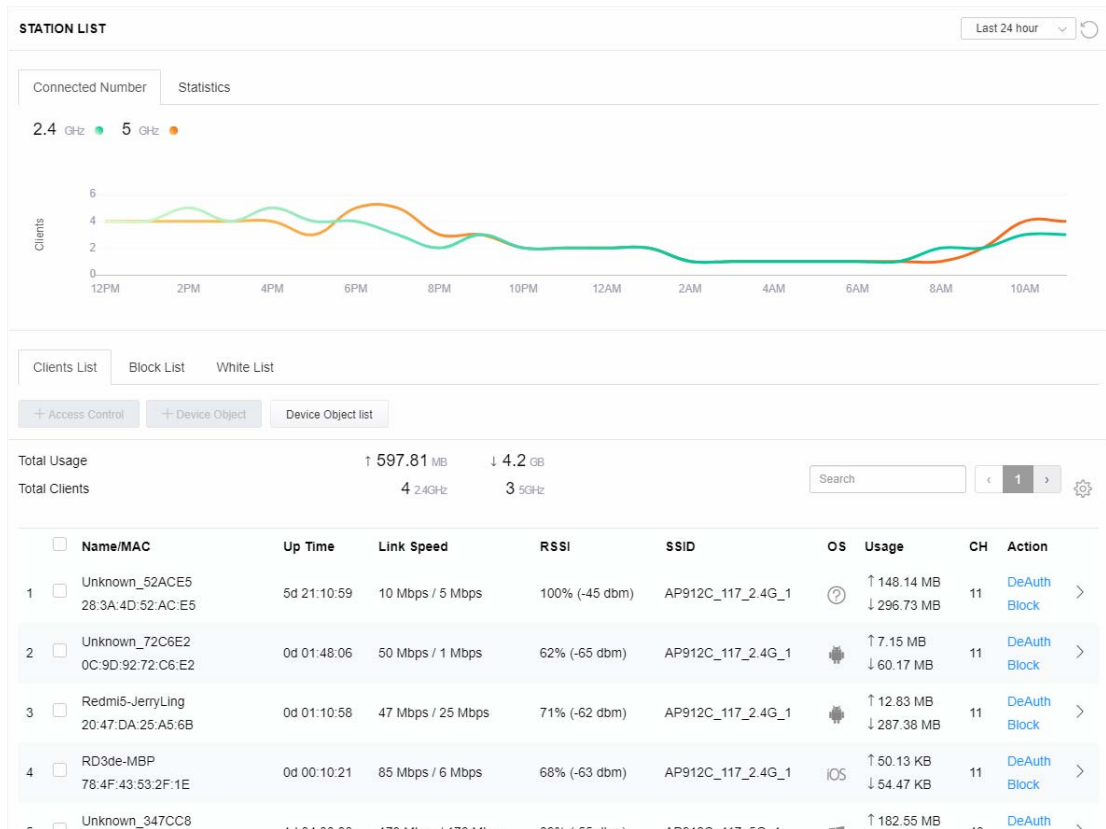

II-3-12-2 Statistics

The number of detected devices and the number of device(s) passed/blocked according to the policy specified in **Mobile Device Management>>Policy** can be illustrated as doughnut chart.

Connected Number

Statistics



0% Android 0
 0% iOS 0
 0% Windows 0
 0% Linux 0
 100% Others 58



100% Pass 58
 0% Block 0

Clients List

Block List

White List

+ Access Control

+ Device Object

Device Object list

Total Usage

↑ 58.13 KB ↓ 45.89 KB

Total Clients

0 2.4GHz 64 5GHz

5g

< 1 2 3 4 5 6 7 >

| <input type="checkbox"/> | Name/MAC | Up Time | Link Speed | RSSI | SSID | OS | Usage | CH | Action |
|--------------------------|--------------------------------------------------------------|-------------|-------------------|---------------|--------|----|--------------------|----|-----------------|
| 1 | <input type="checkbox"/> Unknown_C84A46 00:BC:DA:C8:4A:46 | 0d 03:41:17 | 270 Mbps / 6 Mbps | 57% (-67 dbm) | AA-903 | ? | ↑ 867 B ↓ 717 B | 36 | DeAuth Block |
| 2 | <input type="checkbox"/> Unknown_07B0C1 00:BC:DA:07:B0:C1 | 0d 03:41:17 | 270 Mbps / 6 Mbps | 55% (-68 dbm) | AA-903 | ? | ↑ 867 B ↓ 717 B | 36 | DeAuth Block |
| 3 | <input type="checkbox"/> Unknown_C34F0A 00:BC:DA:C3:4F:0A | 0d 03:41:17 | 270 Mbps / 6 Mbps | 57% (-67 dbm) | AA-903 | ? | ↑ 867 B ↓ 717 B | 36 | DeAuth Block |
| 4 | <input type="checkbox"/> Unknown_0CEEE9 00:BC:DA:0C:EE:E9 | 0d 03:41:16 | 270 Mbps / 6 Mbps | 62% (-65 dbm) | AA-903 | ? | ↑ 867 B ↓ 717 B | 36 | DeAuth Block |
| 5 | <input type="checkbox"/> Unknown_607C8F 00:BC:DA:60:7C:8F | 0d 03:41:16 | 270 Mbps / 6 Mbps | 57% (-67 dbm) | AA-903 | ? | ↑ 867 B ↓ 717 B | 36 | DeAuth Block |
| 6 | <input type="checkbox"/> Unknown_9D28C0 00:BC:DA:9D:28:C0 | 0d 03:41:46 | 270 Mbps / 6 Mbps | 55% (-68 dbm) | AA-903 | ? | ↑ 867 B ↓ 717 B | 36 | DeAuth Block |
| 7 | <input type="checkbox"/> Unknown_79E9C2 00:BC:DA:79:E9:C2 | 0d 03:41:46 | 270 Mbps / 6 Mbps | 57% (-67 dbm) | AA-903 | ? | ↑ 867 B ↓ 717 B | 36 | DeAuth Block |
| 8 | <input type="checkbox"/> Unknown_9B07CE 00:BC:DA:9B:07:CE | 0d 03:41:46 | 270 Mbps / 6 Mbps | 55% (-68 dbm) | AA-903 | ? | ↑ 867 B ↓ 717 B | 36 | DeAuth Block |
| 9 | <input type="checkbox"/> Unknown_AA5A63 00:BC:DA:AA:5A:63 | 0d 03:41:46 | 270 Mbps / 6 Mbps | 55% (-68 dbm) | AA-903 | ? | ↑ 867 B ↓ 717 B | 36 | DeAuth Block |
| 10 | <input type="checkbox"/> Unknown_DD1FA2 00:BC:DA:DD:1F:A2 | 0d 03:41:46 | 270 Mbps / 6 Mbps | 57% (-67 dbm) | AA-903 | ? | ↑ 903 B ↓ 717 B | 36 | DeAuth Block |

II-3-12-3 Clients List

The client list displays all the stations connecting to VigorAP.

STATION LIST ⓘ Last 24 hour ↻

Connected Number Statistics

Device OS

- 0% Android 0
- 0% iOS 0
- 0% Windows 0
- 0% Linux 0
- 100% Others 58

Policy

- 100% Pass 58
- 0% Block 0

Clients List Block List White List

+ Access Control
+ Device Object
Device Object list

Total Usage ↑ 58.13 KB ↓ 45.89 KB

Total Clients 0 2.4GHz 64 5GHz
5g
< 1 2 3 4 5 6 7 >
⚙️

| <input type="checkbox"/> | Name/MAC | Up Time | Link Speed | RSSI | SSID | OS | Usage | CH | Action |
|-------------------------------------|-------------------------------------|-------------|-------------------|---------------|--------|----|--------------------|----|-----------------|
| <input type="checkbox"/> | Unknown_C84A46 00:BC:DA:C8:4A:46 | 0d 03:42:47 | 270 Mbps / 6 Mbps | 57% (-67 dbm) | AA-903 | ? | ↑ 867 B ↓ 717 B | 36 | DeAuth Block |
| <input checked="" type="checkbox"/> | Unknown_07B0C1 00:BC:DA:07:B0:C1 | 0d 03:42:47 | 270 Mbps / 6 Mbps | 55% (-68 dbm) | AA-903 | ? | ↑ 867 B ↓ 717 B | 36 | DeAuth Block |
| <input checked="" type="checkbox"/> | Unknown_C34F0A 00:BC:DA:C3:4F:0A | 0d 03:42:47 | 270 Mbps / 6 Mbps | 57% (-67 dbm) | AA-903 | ? | ↑ 867 B ↓ 717 B | 36 | DeAuth Block |
| <input type="checkbox"/> | Unknown_0CEEE9 00:BC:DA:0C:EE:E9 | 0d 03:42:46 | 270 Mbps / 6 Mbps | 62% (-65 dbm) | AA-903 | ? | ↑ 867 B ↓ 717 B | 36 | DeAuth Block |

Available settings are explained as follows:

| Item | Description | | | | | | | | | |
|------------------------|------------------------------------------------------------------------------------------------------------------------------------------------------------------------------------------------------------------------------------------------------------------------------------------------------------------------------------------------------------------------------------------------------------------------------------------------------------------------------------------------------------------------------------------------------------------------------------------------------------------------------------------------------------------------------------------------------------------------------------------------------------------------------------------------------------------------------------------------------------------------------------------------------------------------------------------------------------------------------------------------------------------------------------------------------------------------------------------------------------------------------------------------------------------------------------------------------------------------------------------------------------------------------------------------------------------------------------------------------------------------------------------------------------------------------------------------------------------------------------------------------------------------------------------------------------------|------------------------------------------------------------------------------------------------------------------------------------------|------|---------------|-------------------|----------------|------------------------------------------------------------------------------------------------------------------------------------------|-------------------|----------------|------------------------------------------------------------------------------------------------------------------------------------------|
| +Access Control | <p>It is available after choosing one of the entries (clients) on Clients List.</p> <div style="border: 1px solid #ccc; padding: 10px; margin: 10px 0;"> <p>Add Access Control ⓘ</p> <p>Wireless LAN 5GHz</p> <hr/> <p>SSID Policy</p> <p>1 Black list AA-903 2 Disable AA-903-2 3 Disable AA-903-3 4 Disable AA-903-4</p> <hr/> <p>From to list</p> <table style="width: 100%; border-collapse: collapse;"> <thead> <tr> <th>Device MAC</th> <th>Name</th> <th>Apply to SSID</th> </tr> </thead> <tbody> <tr> <td>00:BC:DA:07:B0:C1</td> <td>Unknown_07B0C1</td> <td><input type="checkbox"/> All <input type="checkbox"/> 1 <input type="checkbox"/> 2 <input type="checkbox"/> 3 <input type="checkbox"/> 4</td> </tr> <tr> <td>00:BC:DA:C3:4F:0A</td> <td>Unknown_C34F0A</td> <td><input type="checkbox"/> All <input type="checkbox"/> 1 <input type="checkbox"/> 2 <input type="checkbox"/> 3 <input type="checkbox"/> 4</td> </tr> </tbody> </table> <p style="font-size: small; color: red;">Total : 0/256</p> <p style="text-align: right;">Close Save changes</p> </div> <p>Wireless LAN - Specify the bandwidth for the access control list.</p> <p>SSID Policy - Set the policy for each SSID as black list or white list or disable.</p> <p>From to list - Display the clients available for applying this access</p> | Device MAC | Name | Apply to SSID | 00:BC:DA:07:B0:C1 | Unknown_07B0C1 | <input type="checkbox"/> All <input type="checkbox"/> 1 <input type="checkbox"/> 2 <input type="checkbox"/> 3 <input type="checkbox"/> 4 | 00:BC:DA:C3:4F:0A | Unknown_C34F0A | <input type="checkbox"/> All <input type="checkbox"/> 1 <input type="checkbox"/> 2 <input type="checkbox"/> 3 <input type="checkbox"/> 4 |
| Device MAC | Name | Apply to SSID | | | | | | | | |
| 00:BC:DA:07:B0:C1 | Unknown_07B0C1 | <input type="checkbox"/> All <input type="checkbox"/> 1 <input type="checkbox"/> 2 <input type="checkbox"/> 3 <input type="checkbox"/> 4 | | | | | | | | |
| 00:BC:DA:C3:4F:0A | Unknown_C34F0A | <input type="checkbox"/> All <input type="checkbox"/> 1 <input type="checkbox"/> 2 <input type="checkbox"/> 3 <input type="checkbox"/> 4 | | | | | | | | |

control.

Apply to SSID - Check **All** to make the device apply the policies to all SSIDs. Or select the one(s) to make the device apply the policies to the selected SSIDs.

Close - Exit this page without saving any changes.

Save changes - Save the changes and exit this page.

+Device Object

To add a device to device object list, choose one of the entries (clients) on Clients List to enable the Device Object button. Click the button to open the following page.

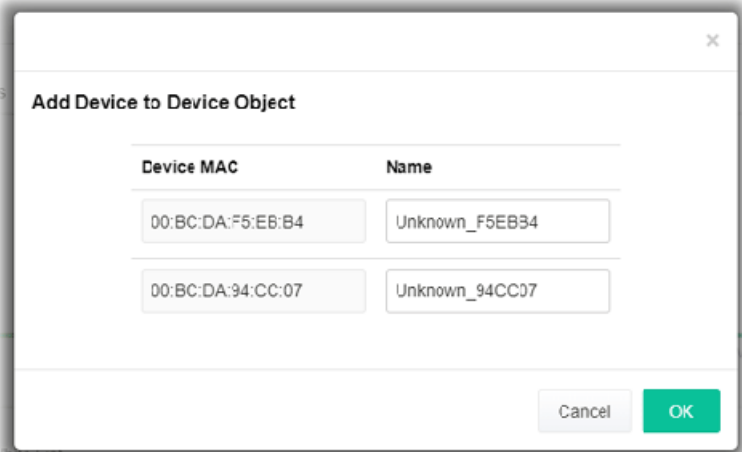

The screenshot shows a dialog box titled "Add Device to Device Object". It contains two rows of input fields. The first row has "Device MAC" as "00:BC:DA:F5:E6:B4" and "Name" as "Unknown_F5EB34". The second row has "Device MAC" as "00:BC:DA:94:CC:07" and "Name" as "Unknown_94CC07". At the bottom right, there are "Cancel" and "OK" buttons.

Check the information listed on the page. Change the MAC address or name of the selected entry if required. Then click **OK** and exit the page.

Device Object list

The existed device object profiles will be shown on the following page.



The screenshot shows a page titled "DEVICE OBJECT" with a section "Device Object Profiles". There is a search bar and a "Set to Factory Default" button. Below is a table with the following data:

| Profile | MAC | Name |
|---------|-------------------|--------|
| 1 | 00:50:7F:F1:91:BC | TEST_1 |
| 2 | 00:50:7F:00:52:BA | TEST_2 |

Clients List

Display the stations connecting to this Vigor device.

Total Usage - Display

Total Clients - Display the number of the clients using 2.4GHz

Name / MAC - Display the host name / MAC address of the connecting client.

Up Time - Display the connection time.

Link Speed- Display the link speed.

RSSI - Display the RSSI value.

SSID - Display the SSID the client used for connecting VigorAP.

OS - Display the OS of the client.

Usage - Display the bandwidth usage (up and down) of the client.

CH - Display the channel used by the client.

Action - Display the authentication method used by the client, and if it is on block list or white list.

II-3-12-4 Block List

This page displays information of the stations under block list.

STATION LIST ⓘ Last 24 hour ↻

Connected Number Statistics

2.4 GHz ● 5 GHz ●

Clients List Block List White List

+ Access Control + Device Object Device Object list

Search ⚙️

< 1 >

| | Name / MAC | SSID | Reason | Action |
|---|-------------------------------------|--------|--------|-------------------------|
| 1 | Unknown_457823 00:BC:DB:45:78:23 | AA-903 | ACL | Unblock |
| 2 | Unknown_A566C8 00:BC:DB:A5:66:C8 | AA-903 | ACL | Unblock |

Total list 2

Available settings are explained as follows:

| Item | Description |
|---------------------------|-------------------------------------------------------------------------------------------------------------------------------------------------------|
| Device Object list | Click it to open the Device Object List dialog for reference.  |
| Name / MAC | Display the host name / MAC Address for the connecting client. |
| SSID | Display the SSID that the wireless client connects to. |
| Reason | Display the reference information. |
| Action | Display the action that you can execute for the station. Unblock - Click to unblock the entry. |

II-3-12-5 White List

This page displays general information of the stations under white list.

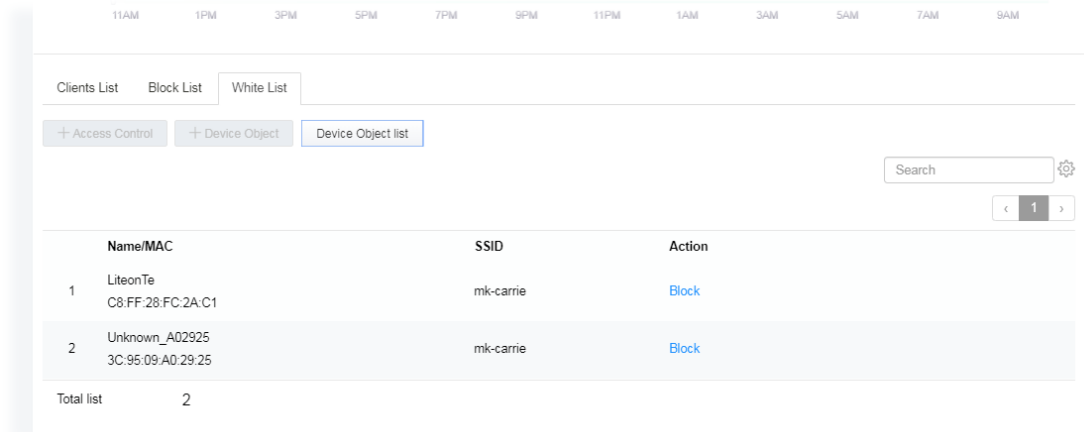

Available settings are explained as follows:

| Item | Description |
|---------------------------|------------------------------------------------------------------------------------------------------------------------------------------------------|
| Device Object list | Click it to open the Device Object List dialog for reference.  |
| Name / MAC | Display the host name / MAC Address for the connecting client. |
| SSID | Display the SSID that the wireless client connects to. |
| Action | Display the action that you can execute for the station. Block - Click to block the entry. |

II-4 Mesh Settings for Mesh Mode

When you choose **Mesh** as the operation mode, the Mesh menu with the settings of Mesh Setup, Mesh Status, Mesh Discovery, Configuration Sync, Support List and Mesh Syslog will be shown on the screen.



Please note that, within VigorMesh network,

- the total number allowed for mesh nodes is 8 (including the mesh root)
- the maximum number of hop is 3

Refer to the following figure:

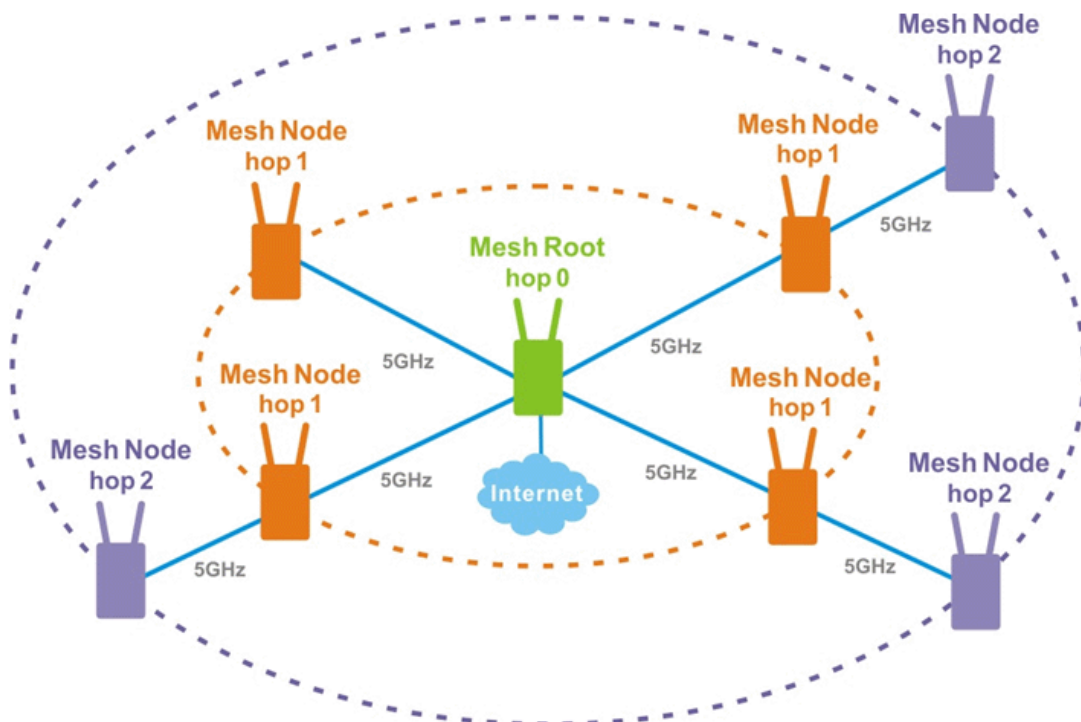

For the mesh group set within VigorMesh network,

- It must be composed by "1" Mesh Root and "0~7" mesh nodes
- (Roaming) Normally members in a mesh group use the same Wireless SSID/security

- (Add) Only the mesh root can add a new mesh node into the mesh group
- (Recover) A disconnected mesh node will automatically try to connect to another connected mesh node of the same group

Mesh Root and Mesh Node

Mesh Root indicates that VigorAP would be other AP's uplink connection. As a Mesh Root, VigorAP must connect to a gateway with Ethernet cable first to have an internet connection.

As a Mesh Node, VigorAP can connect to the mesh root or mesh node within the same mesh group via wireless network or physical connection with an Ethernet cable.

The following figure shows how VigorAP runs as MESH ROOT:

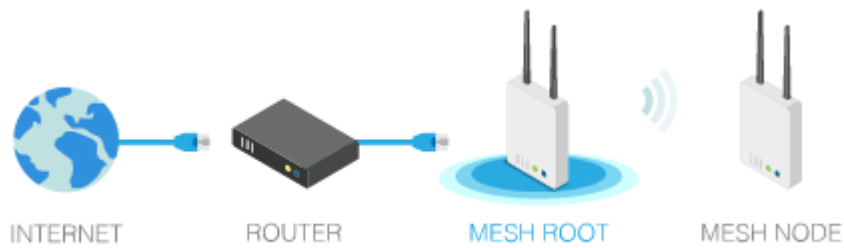

The following figure shows how VigorAP runs as MESH NODE:



II-4-1 Mesh Setup

Such page can determine the role of the VigorAP connecting to the computer physically. For a mesh root, you can search and specify mesh nodes as members under current mesh group.

Mesh >> Mesh Setup

General Setup

Role Mesh Root Mesh Node

Wireless Downlink Band Auto ▾

Group Name

Auto Reselect

Log Level Detailed ▾

Mesh Group

| Select | Index | Role | MAC Address | Model | CFG Sync | CFG Check | Device Name |
|--------------------------|-------|------|-------------------|-------------|----------|-----------|-------------|
| <input type="checkbox"/> | 1 | Root | 14:49:BC:42:75:CC | VigorAP960C | | | |

Add Mesh Node

Press Search button below to find and adopt the new node into Mesh group.

Backup Mesh Config

Available settings are explained as follows:

| Item | Description |
|----------------------|-------------------------------------------------------------------------------------------------------------------------------------------------------------------------------------------------------------------------------------------------------------------------------------------------------------------------------------------------------------------------------------------------------------------------------------------------------------------------------------------------------------------------------------------------------------------------------------------------------------------------------------------------------------------------|
| General Setup | |
| Role | <p>Mesh Root – When VigorAP is connected to a Vigor router with a physical Ethernet cable, it can be set as mesh root to deliver the wireless signals to a mesh node AP.</p> <p>Mesh Node – As a mesh node, such VigorAP can pass the wireless connection signal to other mesh node or a remote device (PC, CPE, mobile phone).</p> <p>In addition, VigorAP can be searched by mesh root AP and join the mesh group of the root AP. The configuration set for mesh root can be applied to mesh node.</p> <p>Log Level – Choose Basic or Detailed. Related information will be shown on the Diagnostics>>System Log.</p> |

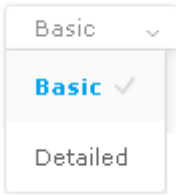
| |  | | | | | | | | | | |
|------------------------------------------|----------------------------------------------------------------------------------------------------------------------------------------------------------------------------------------------------------------------------------------------------------------------------------------------------------------------------------------------------------------------------------------------------------------------------------------------------------------------------------------------------------------------------------------------------------------------------------------------------------------------------------------------------------------------------------------------------------------------------------------------------------------------------------------------------------------------|------------|--------------------|----------------------|----------------|-------------|--------------------------|-------------------|------------|--------------------|----------------------|
| <p>When Mesh Root is selected</p> | <p>Wireless Downlink Band – Choose a wireless band for connecting with a downlink mesh root or a downlink mesh node.</p> <p>Group Name - Display the name of the current mesh group.</p> <p>Auto Reselect - It is selected in default. To perform the auto reselect, make sure the process for CFG Sync and CFG Check for mesh nodes are successful. If enabled, after changing the environment of mesh network (e.g., offline, disconnection), the root device will perform auto reselect to reconstruct the mesh network.</p> | | | | | | | | | | |
| <p>When Mesh Node is selected</p> | <p>Wired Uplink – Check the box if such VigorAP connects to an uplink mesh root or an uplink mesh node with an Ethernet cable.</p> <p>Wireless Uplink/Downlink Band – Choose a wireless band for connecting with an uplink/downlink mesh root or an uplink/downlink mesh node.</p> | | | | | | | | | | |
| <p>Mesh Group</p> | <p>When the VigorAP is set as mesh root or is added to a mesh group, the basic information including role, MAC address, and model name of the AP will be shown in this area.</p> <p>Up to 8 entries (one mesh root and seven mesh nodes) will be shown on this field.</p> <p>Reset - Click it to clear the Mesh Group information.</p> <p>Delete - Click it to remove the selected entry.</p> | | | | | | | | | | |
| <p>Add Mesh Node</p> | <p>Click Search to find out available mesh node on the network.</p> <div data-bbox="652 1258 1406 1476" data-label="Form"> <p>Add Mesh Node</p> <p>Press Search button below to find and adopt the new node into Mesh group.</p> <p><input type="button" value="Search"/></p> <p>Search List</p> <table border="1"> <thead> <tr> <th>Select</th> <th>MAC Address</th> <th>Model</th> <th>Operation Mode</th> <th>Device Name</th> </tr> </thead> <tbody> <tr> <td><input type="checkbox"/></td> <td>00:1D:AA:22:33:08</td> <td>VigorAP903</td> <td>MeshNode(Wireless)</td> <td><input type="text"/></td> </tr> </tbody> </table> <p><input type="button" value="Apply"/></p> </div> <p>Check the one you want and click Apply. The selected AP will be added onto current mesh root.</p> | Select | MAC Address | Model | Operation Mode | Device Name | <input type="checkbox"/> | 00:1D:AA:22:33:08 | VigorAP903 | MeshNode(Wireless) | <input type="text"/> |
| Select | MAC Address | Model | Operation Mode | Device Name | | | | | | | |
| <input type="checkbox"/> | 00:1D:AA:22:33:08 | VigorAP903 | MeshNode(Wireless) | <input type="text"/> | | | | | | | |
| <p>Backup Mesh Config</p> | <p>Backup – Click the button to save the configuration as a file.</p> <p>Upload/Restore – Click the Upload button to specify a configuration file. Then click Restore to apply the configuration.</p> <p>When the MAC address of such VigorAP does not appear under the mesh group, the restore operation will not succeed and the error message, "Device MAC is not in mesh group list", will be shown instead.</p> | | | | | | | | | | |

How to set up a mesh group?

The following steps will guide you how to setup a Mesh Group (with mesh root and mesh node) from **Mesh >> Mesh Setup**.

1. Open **Mesh>>Mesh Setup**. Click **Mesh Root** and click **OK** for the VigorAP connected to PC with Ethernet cable. At first, a Mesh Group is with only Mesh Root.

Mesh >> Mesh Setup

General Setup

| | |
|------------------------|----------------------------------------------------------------------------|
| Role | <input checked="" type="radio"/> Mesh Root <input type="radio"/> Mesh Node |
| Wireless Downlink Band | Auto |
| Group Name | VigorMesh |
| Auto Reselect | <input checked="" type="checkbox"/> |
| Log Level | Detailed |

Mesh Group

| Select | Index | Role | MAC Address | Model | CFG Sync | CFG Check | Device Name |
|--------|-------|------|-------------------|-------------|----------|-----------|-------------|
| | 1 | Root | 14:49:BC:42:75:CC | VigorAP960C | | | |

Reset

OK

Cancel

2. Click the **Search** button in the field of **Add Mesh Node**.

Mesh Group

| Select | Index | Role | MAC Address | Model | CFG Sync | CFG Check | Device Name |
|--------|-------|------|-------------------|-------------|----------|-----------|-------------|
| | 1 | Root | 14:49:BC:42:75:CC | VigorAP960C | | | |

Reset

OK

Cancel

Add Mesh Node

Press Search button below to find and adopt the new node into Mesh group.

Search

Backup Mesh Config

Backup Upload ... Restore

- Wait until the searching result appears.

Add Mesh Node

Press Search button below to find and adopt the new node into Mesh group.

Search List

| Select | MAC Address | Model | Operation Mode | Device Name |
|--------------------------|-------------------|---------------|--------------------|----------------------|
| <input type="checkbox"/> | 00:50:7F:F1:7E:EA | VigorAP903 | MeshNode(Wireless) | <input type="text"/> |
| <input type="checkbox"/> | 00:1D:AA:04:F0:10 | VigorAP1000C | MeshNode(Wireless) | <input type="text"/> |
| <input type="checkbox"/> | 00:1D:AA:32:BC:24 | VigorAP920RPD | MeshNode(Wired) | <input type="text"/> |
| <input type="checkbox"/> | 00:1D:AA:78:C9:20 | VigorAP920R | MeshNode(Wireless) | <input type="text"/> |
| <input type="checkbox"/> | 00:1D:AA:78:CF:B0 | VigorAP920R | MeshNode(Wireless) | <input type="text"/> |
| <input type="checkbox"/> | 00:1D:AA:68:D6:18 | VigorAP920RPD | MeshNode(Wired) | <input type="text"/> |

Backup Mesh Config

- Choose the device(s) you want to add to the Mesh Group as mesh node(s) and define the **Device Name** for each node. In this example, five devices are specified as mesh nodes.

Add Mesh Node

Press Search button below to find and adopt the new node into Mesh group.

Search List

| Select | MAC Address | Model | Operation Mode | Device Name |
|-------------------------------------|-------------------|---------------|--------------------|------------------------------------|
| <input checked="" type="checkbox"/> | 00:50:7F:F1:7E:EA | VigorAP903 | MeshNode(Wireless) | <input type="text" value="room1"/> |
| <input checked="" type="checkbox"/> | 00:1D:AA:04:F0:10 | VigorAP1000C | MeshNode(Wireless) | <input type="text" value="room2"/> |
| <input type="checkbox"/> | 00:1D:AA:32:BC:24 | VigorAP920RPD | MeshNode(Wired) | <input type="text"/> |
| <input checked="" type="checkbox"/> | 00:1D:AA:78:C9:20 | VigorAP920R | MeshNode(Wireless) | <input type="text" value="room3"/> |
| <input checked="" type="checkbox"/> | 00:1D:AA:78:CF:B0 | VigorAP920R | MeshNode(Wireless) | <input type="text" value="room4"/> |
| <input checked="" type="checkbox"/> | 00:1D:AA:68:D6:18 | VigorAP920RPD | MeshNode(Wired) | <input type="text" value="room5"/> |

Backup Mesh Config

- Click the **Apply** button and wait for it to finish the procedure.

Add Mesh Node

Press Search button below to find and adopt the new node into Mesh group.

Search

Search List

| Select | MAC Address | Model | Operation Mode | Device Name |
|-------------------------------------|-------------------|---------------|--------------------|-------------|
| <input checked="" type="checkbox"/> | 00:50:7F:F1:7E:EA | VigorAP903 | MeshNode(Wireless) | room1 |
| <input checked="" type="checkbox"/> | 00:1D:AA:04:F0:10 | VigorAP1000C | MeshNode(Wireless) | room2 |
| <input type="checkbox"/> | 00:1D:AA:32:BC:24 | VigorAP920RPD | MeshNode(Wired) | |
| <input checked="" type="checkbox"/> | 00:1D:AA:78:C9:20 | VigorAP920R | MeshNode(Wireless) | room3 |
| <input checked="" type="checkbox"/> | 00:1D:AA:78:CF:B0 | VigorAP920R | MeshNode(Wireless) | room4 |
| <input checked="" type="checkbox"/> | 00:1D:AA:68:D6:18 | VigorAP920RPD | MeshNode(Wired) | room5 |

Apply 

Backup Mesh Config

Backup Upload ... Restore

- After finishing the mesh network configuration, refer to **Mesh>>Mesh Status** for viewing the result. A mesh root with 5 mesh nodes is online.

Mesh >> Mesh Status [Refresh](#)

Local Status

| | |
|------------------------|----------------------------------------------------------------|
| Device Name | VigorAP960C |
| MAC Address | 14:49:BC:42:75:CC |
| Model | VigorAP960C |
| Operation Mode | MeshRoot |
| Wireless Downlink Band | Auto |
| Group Name | VigorMesh |
| Link Status | Registering |
| Hop | 0 |
| Downlink Number | 5 |
| Downlink | 00:1D:AA:04:F0:10 (VigorAP1000C) Wireless 5GHz (Ch36) (-38dBm) |
| | 00:1D:AA:78:CF:B0 (VigorAP920R) Wireless 5GHz (Ch36) (-74dBm) |
| | 00:1D:AA:68:D6:18 (VigorAP920RPD) Ethernet |
| | 00:1D:AA:78:C9:20 (VigorAP920R) Wireless 5GHz (Ch36) (-54dBm) |
| | 00:50:7F:F1:7E:EA (VigorAP903) Wireless 5GHz (Ch36) (-33dBm) |

Devices Total number of Clients: 0

| Index | Status | Device Name | IP Address | MAC Address (Model) | Hop | Uplink | Uptime | Clients |
|-------|--------|-------------|-------------|-----------------------------------|-----|-------------------------------------------------|-------------|---------|
| 1 | Root | VigorAP903 | 172.17.3.97 | 00:50:7F:F1:7E:ED (VigorAP903) | 0 | | 0d 01:16:17 | 0 |
| 2 | Online | room1 | 172.17.3.12 | 00:50:7F:F1:7E:EA (VigorAP903) | 1 | 00:50:7F:F1:7E:ED Wireless 5GHz (Ch36) (-30dBm) | 0d 00:21:43 | 0 |
| 3 | Online | room2 | 172.17.3.8 | 00:1D:AA:04:F0:10 (VigorAP1000C) | 1 | 00:50:7F:F1:7E:ED Wireless 5GHz (Ch36) (-40dBm) | 0d 00:44:50 | 0 |
| 4 | Online | room3 | 172.17.3.6 | 00:1D:AA:78:C9:20 (VigorAP920R) | 1 | 00:50:7F:F1:7E:ED Wireless 5GHz (Ch36) (-47dBm) | 0d 01:01:46 | 0 |
| 5 | Online | room4 | 172.17.3.98 | 00:1D:AA:78:CF:B0 (VigorAP920R) | 1 | 00:50:7F:F1:7E:ED Wireless 5GHz (Ch36) (-64dBm) | 0d 01:02:01 | 0 |
| 6 | Online | room5 | 172.17.3.10 | 00:1D:AA:68:D6:18 (VigorAP920RPD) | 0 | 00:50:7F:F1:7E:ED Ethernet | 0d 01:03:05 | 0 |

● Online(sync ready) ● Online ● Offline

Last updated: Thu Nov 8 18:40:51 2018

II-4-2 Mesh Status

This page shows that one Mesh Group can contain up to 8 devices. A device with hop 0 indicates that it is one special Ethernet Backhaul. It means this node will use Ethernet cable to join the mesh group while others use the wireless link.

Mesh >> Mesh Status

| Local Status | | Refresh |
|------------------------|-------------------|-------------------------|
| Device Name | VigorAP960C | |
| MAC Address | 14:49:BC:42:75:CC | |
| Model | VigorAP960C | |
| Operation Mode | MeshRoot | |
| Wireless Downlink Band | Auto | |
| Group Name | VigorMesh | |
| Link Status | Registering | |
| Hop | 0 | |
| Downlink Number | 0 | |

| Devices | | | | | | | Total number of Clients: 0 | | |
|---------|--------------------------------------------|---------------|--------------|-----------------------------------|-----|---------------|----------------------------|------------|--------------------------|
| Index | Status | Device Name | IP Address | MAC Address (Model) | Hop | Uplink Uptime | Clients | Speed Test | Action |
| 1 | ● Root | VigorAP960... | 192.168.1.10 | 14:49:BC:42:75:CC (VigorAP960C) | 0 | 0d 00:22:56 | 0 | | Reselect |
| 2 | ● Offline | MKT01 | | 14:49:BC:42:7D:BA (VigorAP960C) | | | | | |
| 3 | ● Offline | MKT02 | | 00:1D:AA:3F:58:0C (VigorAP918RPD) | | | | | |

● Online(sync ready)
 ● Online
 ● Offline
 Last updated: Tue Oct 6 10:44:02 2020

| Item | Description | | | | | | | | | | | | | | | | | | | | | | | | | | | | | | | | | | | | | | | | | | | | | | | | | | | | | | | | | | | | | | | | | | | | | | | | | | | | | | | | | | | | | | | | | | | | | | | | | | | | | | | | | | | | | | | | | | | | | | | | | | | | | | | | | | | | | | | | | | | | | | | | | | | | | | | | | | | | | | | | | | | | | | | | | | | | | | | | |
|--------------------------------|-------------------------------------------------------------------------------------------------------------------------------------------------------------------------------------------------------------------------------------------------------------------------------------------------------------------------------------------------------------------------------------------------------------------------------------------------------------------------------------------------------------------------------------------------------------------------------------------------------------------------------------------------------------------------------------------------------------------------------------------------------------------------------------------------------------------------------------------------------------------------------------------------------------------------------------------------------------------------------------------------------------------------------------------------------------------------------------------------------------------------------------------------------------------------------------------------------------------------------------------------------------------------------------------------------------------------------------------------------------------------------------------------------------------------------------------------------------------------------------------------------------------------------------------------------------------------------------------------------------------------------------------------------------------------------------------------------------------------------------------------------------------------------------------------------------------------------------------------------------------------------------------------------------------------------------------------------------------------------------------------------------------------------------------------------------------------------------------------------------------------------------------------------------------------------------------------------------------------------------------------------------------------------------------------------------------------------------------------------------------------------------------------------------------------------------------------------------------------------------------------------------------------------------------------------------------------------------------------------------------------------------------------------------------------------------------------------------------------------------------------------------------------------------------------------------------------------------------------------------------------------------------------------------------------------------------------------------------------------------------------------------------------------------------------------------------------------------------------------------------------------------------------------------------------------------------------------------------|-----------------------------|----------|---------------|---------|--------------|---------------------------|--|--|-------|-------------|----------|--------|------|---------|------|---------------------------|---|-------------------|----------|---------|-----------|---|-------------|-----|---|-------------------|----------|---------|-----------|---|-------------|-----|---|-------------------|---------------|-------|-----------|---|--------------|-----|---|-------------------|---------------|-------|--------|---|-------------|-----|---|-------------------|-----|---------|-----------|---|-------------|-----|---|-------------------|-----|---------|-----------|---|-------------|-----|---|-------------------|-----|-------|--------|---|-------------|-------|---|-------------------|-----|----------|--------|---|-------------|------|---|-------------------|-----|-------|-----------|---|--------------|-----|----|-------------------|-----|-----|-----------|---|-------------|-----|----|-------------------|-----|---------|-----------|---|-------------|-----|----|-------------------|-----|-------|--------|---|-------------|-----|----|-------------------|---------------|-----|-----------|---|-------------|-----|----|-------------------|---------------|-----|-----------|---|-------------|-----|----|-------------------|-----|-------|-----------|---|-------------|-----|----|-------------------|---------------|------|--------|---|-------------|-----|----|-------------------|-----|-----|---------------|----|-------------|-----|----|-------------------|---------------|-----|---------------|----|-------------|-----|----|-------------------|-------|-------|---------------|----|-------------|-----|----|-------------------|-----|-------|---------------|----|-------------|-----|
| Local Status | Display general information for such VigorAP. | | | | | | | | | | | | | | | | | | | | | | | | | | | | | | | | | | | | | | | | | | | | | | | | | | | | | | | | | | | | | | | | | | | | | | | | | | | | | | | | | | | | | | | | | | | | | | | | | | | | | | | | | | | | | | | | | | | | | | | | | | | | | | | | | | | | | | | | | | | | | | | | | | | | | | | | | | | | | | | | | | | | | | | | | | | | | | | | |
| Devices | Display detailed information for this VigorAP (as mesh root) and mesh node(s) in the group. Index – Display the number of the device within a mesh group. Status – Display the role of the device within a mesh group. Device Name – Display the name of the device (for identification). IP Address – Display the IP address of the device. MAC Address – Display the MAC address of the device. Hop – Display the level of the devices within a mesh group. "0" means the access point is connected to a device by using Ethernet cable (wired). "1" to "3" means the level of the access point within a mesh group and it connects to other access point via wireless link. Uplink – Display the MAC address of the device that the AP connects to. | | | | | | | | | | | | | | | | | | | | | | | | | | | | | | | | | | | | | | | | | | | | | | | | | | | | | | | | | | | | | | | | | | | | | | | | | | | | | | | | | | | | | | | | | | | | | | | | | | | | | | | | | | | | | | | | | | | | | | | | | | | | | | | | | | | | | | | | | | | | | | | | | | | | | | | | | | | | | | | | | | | | | | | | | | | | | | | | |
| Total number of Clients | Display the station list of all mesh devices. <table border="1" style="font-size: small;"> <thead> <tr> <th colspan="8">Station List of All Devices</th> </tr> <tr> <th>Index</th> <th>MAC Address</th> <th>Hostname</th> <th>Vendor</th> <th>SSID</th> <th>Channel</th> <th>RSSI</th> <th>TxRate(Kbps) RxRate(Kbps)</th> </tr> </thead> <tbody> <tr><td>1</td><td>00:50:7F:F0:C9:72</td><td>TA001029</td><td>DrayTek</td><td>staffs_4F</td><td>6</td><td>68%(-63dBm)</td><td>0 0</td></tr> <tr><td>2</td><td>00:50:7F:F0:D1:1D</td><td>ta002171</td><td>DrayTek</td><td>staffs_4F</td><td>6</td><td>41%(-73dBm)</td><td>0 0</td></tr> <tr><td>3</td><td>5C:97:F3:D3:D5:F7</td><td>Tze-Pingde...</td><td>Apple</td><td>staffs_4F</td><td>6</td><td>100%(-49dBm)</td><td>0 0</td></tr> <tr><td>4</td><td>40:98:AD:58:F2:52</td><td>Tyronetkil...</td><td>Apple</td><td>staffs</td><td>6</td><td>55%(-68dBm)</td><td>0 0</td></tr> <tr><td>5</td><td>00:50:7F:37:6D:E5</td><td>N/A</td><td>DrayTek</td><td>staffs_4F</td><td>6</td><td>52%(-69dBm)</td><td>0 0</td></tr> <tr><td>6</td><td>00:50:7F:37:67:BE</td><td>N/A</td><td>DrayTek</td><td>staffs_4F</td><td>6</td><td>55%(-68dBm)</td><td>0 0</td></tr> <tr><td>7</td><td>30:F7:C5:1D:3D:11</td><td>N/A</td><td>Apple</td><td>guests</td><td>6</td><td>83%(-57dBm)</td><td>30 12</td></tr> <tr><td>8</td><td>40:F0:2F:22:EB:A0</td><td>N/A</td><td>LiteonTe</td><td>staffs</td><td>6</td><td>34%(-76dBm)</td><td>22 4</td></tr> <tr><td>9</td><td>18:65:90:DE:D4:E5</td><td>N/A</td><td>Apple</td><td>staffs_4F</td><td>6</td><td>100%(-44dBm)</td><td>0 0</td></tr> <tr><td>10</td><td>60:45:CB:57:1F:36</td><td>N/A</td><td>N/A</td><td>staffs_4F</td><td>6</td><td>15%(-84dBm)</td><td>0 0</td></tr> <tr><td>11</td><td>AC:5F:3E:62:E6:0D</td><td>N/A</td><td>Samsung</td><td>staffs_4F</td><td>6</td><td>81%(-58dBm)</td><td>0 0</td></tr> <tr><td>12</td><td>50:BC:96:E0:00:11</td><td>N/A</td><td>Apple</td><td>staffs</td><td>6</td><td>71%(-62dBm)</td><td>0 0</td></tr> <tr><td>13</td><td>04:81:67:52:48:90</td><td>Redmi5-mys...</td><td>N/A</td><td>staffs_4F</td><td>6</td><td>45%(-72dBm)</td><td>0 0</td></tr> <tr><td>14</td><td>04:C2:3E:3F:CB:F8</td><td>android-ac...</td><td>HTC</td><td>staffs_4F</td><td>6</td><td>55%(-68dBm)</td><td>0 0</td></tr> <tr><td>15</td><td>0C:8B:FD:31:0B:78</td><td>N/A</td><td>Intel</td><td>staffs_4F</td><td>6</td><td>89%(-55dBm)</td><td>2 2</td></tr> <tr><td>16</td><td>58:48:22:EB:F8:62</td><td>android-Sf...</td><td>Sony</td><td>staffs</td><td>6</td><td>55%(-68dBm)</td><td>0 0</td></tr> <tr><td>17</td><td>CC:9F:7A:63:11:27</td><td>N/A</td><td>N/A</td><td>staffs_4F5...</td><td>36</td><td>52%(-69dBm)</td><td>0 0</td></tr> <tr><td>18</td><td>20:47:DA:58:17:79</td><td>RedmiNote5...</td><td>N/A</td><td>staffs_4F5...</td><td>36</td><td>50%(-70dBm)</td><td>0 0</td></tr> <tr><td>19</td><td>70:81:EB:65:80:E5</td><td>cheng</td><td>Apple</td><td>staffs_4F5...</td><td>36</td><td>87%(-56dBm)</td><td>0 0</td></tr> <tr><td>20</td><td>8C:85:90:64:FE:A4</td><td>N/A</td><td>Apple</td><td>staffs_4F5...</td><td>36</td><td>36%(-75dBm)</td><td>0 0</td></tr> </tbody> </table> | Station List of All Devices | | | | | | | | Index | MAC Address | Hostname | Vendor | SSID | Channel | RSSI | TxRate(Kbps) RxRate(Kbps) | 1 | 00:50:7F:F0:C9:72 | TA001029 | DrayTek | staffs_4F | 6 | 68%(-63dBm) | 0 0 | 2 | 00:50:7F:F0:D1:1D | ta002171 | DrayTek | staffs_4F | 6 | 41%(-73dBm) | 0 0 | 3 | 5C:97:F3:D3:D5:F7 | Tze-Pingde... | Apple | staffs_4F | 6 | 100%(-49dBm) | 0 0 | 4 | 40:98:AD:58:F2:52 | Tyronetkil... | Apple | staffs | 6 | 55%(-68dBm) | 0 0 | 5 | 00:50:7F:37:6D:E5 | N/A | DrayTek | staffs_4F | 6 | 52%(-69dBm) | 0 0 | 6 | 00:50:7F:37:67:BE | N/A | DrayTek | staffs_4F | 6 | 55%(-68dBm) | 0 0 | 7 | 30:F7:C5:1D:3D:11 | N/A | Apple | guests | 6 | 83%(-57dBm) | 30 12 | 8 | 40:F0:2F:22:EB:A0 | N/A | LiteonTe | staffs | 6 | 34%(-76dBm) | 22 4 | 9 | 18:65:90:DE:D4:E5 | N/A | Apple | staffs_4F | 6 | 100%(-44dBm) | 0 0 | 10 | 60:45:CB:57:1F:36 | N/A | N/A | staffs_4F | 6 | 15%(-84dBm) | 0 0 | 11 | AC:5F:3E:62:E6:0D | N/A | Samsung | staffs_4F | 6 | 81%(-58dBm) | 0 0 | 12 | 50:BC:96:E0:00:11 | N/A | Apple | staffs | 6 | 71%(-62dBm) | 0 0 | 13 | 04:81:67:52:48:90 | Redmi5-mys... | N/A | staffs_4F | 6 | 45%(-72dBm) | 0 0 | 14 | 04:C2:3E:3F:CB:F8 | android-ac... | HTC | staffs_4F | 6 | 55%(-68dBm) | 0 0 | 15 | 0C:8B:FD:31:0B:78 | N/A | Intel | staffs_4F | 6 | 89%(-55dBm) | 2 2 | 16 | 58:48:22:EB:F8:62 | android-Sf... | Sony | staffs | 6 | 55%(-68dBm) | 0 0 | 17 | CC:9F:7A:63:11:27 | N/A | N/A | staffs_4F5... | 36 | 52%(-69dBm) | 0 0 | 18 | 20:47:DA:58:17:79 | RedmiNote5... | N/A | staffs_4F5... | 36 | 50%(-70dBm) | 0 0 | 19 | 70:81:EB:65:80:E5 | cheng | Apple | staffs_4F5... | 36 | 87%(-56dBm) | 0 0 | 20 | 8C:85:90:64:FE:A4 | N/A | Apple | staffs_4F5... | 36 | 36%(-75dBm) | 0 0 |
| Station List of All Devices | | | | | | | | | | | | | | | | | | | | | | | | | | | | | | | | | | | | | | | | | | | | | | | | | | | | | | | | | | | | | | | | | | | | | | | | | | | | | | | | | | | | | | | | | | | | | | | | | | | | | | | | | | | | | | | | | | | | | | | | | | | | | | | | | | | | | | | | | | | | | | | | | | | | | | | | | | | | | | | | | | | | | | | | | | | | | | | | | |
| Index | MAC Address | Hostname | Vendor | SSID | Channel | RSSI | TxRate(Kbps) RxRate(Kbps) | | | | | | | | | | | | | | | | | | | | | | | | | | | | | | | | | | | | | | | | | | | | | | | | | | | | | | | | | | | | | | | | | | | | | | | | | | | | | | | | | | | | | | | | | | | | | | | | | | | | | | | | | | | | | | | | | | | | | | | | | | | | | | | | | | | | | | | | | | | | | | | | | | | | | | | | | | | | | | | | | | | | | | | | | | |
| 1 | 00:50:7F:F0:C9:72 | TA001029 | DrayTek | staffs_4F | 6 | 68%(-63dBm) | 0 0 | | | | | | | | | | | | | | | | | | | | | | | | | | | | | | | | | | | | | | | | | | | | | | | | | | | | | | | | | | | | | | | | | | | | | | | | | | | | | | | | | | | | | | | | | | | | | | | | | | | | | | | | | | | | | | | | | | | | | | | | | | | | | | | | | | | | | | | | | | | | | | | | | | | | | | | | | | | | | | | | | | | | | | | | | | |
| 2 | 00:50:7F:F0:D1:1D | ta002171 | DrayTek | staffs_4F | 6 | 41%(-73dBm) | 0 0 | | | | | | | | | | | | | | | | | | | | | | | | | | | | | | | | | | | | | | | | | | | | | | | | | | | | | | | | | | | | | | | | | | | | | | | | | | | | | | | | | | | | | | | | | | | | | | | | | | | | | | | | | | | | | | | | | | | | | | | | | | | | | | | | | | | | | | | | | | | | | | | | | | | | | | | | | | | | | | | | | | | | | | | | | | |
| 3 | 5C:97:F3:D3:D5:F7 | Tze-Pingde... | Apple | staffs_4F | 6 | 100%(-49dBm) | 0 0 | | | | | | | | | | | | | | | | | | | | | | | | | | | | | | | | | | | | | | | | | | | | | | | | | | | | | | | | | | | | | | | | | | | | | | | | | | | | | | | | | | | | | | | | | | | | | | | | | | | | | | | | | | | | | | | | | | | | | | | | | | | | | | | | | | | | | | | | | | | | | | | | | | | | | | | | | | | | | | | | | | | | | | | | | | |
| 4 | 40:98:AD:58:F2:52 | Tyronetkil... | Apple | staffs | 6 | 55%(-68dBm) | 0 0 | | | | | | | | | | | | | | | | | | | | | | | | | | | | | | | | | | | | | | | | | | | | | | | | | | | | | | | | | | | | | | | | | | | | | | | | | | | | | | | | | | | | | | | | | | | | | | | | | | | | | | | | | | | | | | | | | | | | | | | | | | | | | | | | | | | | | | | | | | | | | | | | | | | | | | | | | | | | | | | | | | | | | | | | | | |
| 5 | 00:50:7F:37:6D:E5 | N/A | DrayTek | staffs_4F | 6 | 52%(-69dBm) | 0 0 | | | | | | | | | | | | | | | | | | | | | | | | | | | | | | | | | | | | | | | | | | | | | | | | | | | | | | | | | | | | | | | | | | | | | | | | | | | | | | | | | | | | | | | | | | | | | | | | | | | | | | | | | | | | | | | | | | | | | | | | | | | | | | | | | | | | | | | | | | | | | | | | | | | | | | | | | | | | | | | | | | | | | | | | | | |
| 6 | 00:50:7F:37:67:BE | N/A | DrayTek | staffs_4F | 6 | 55%(-68dBm) | 0 0 | | | | | | | | | | | | | | | | | | | | | | | | | | | | | | | | | | | | | | | | | | | | | | | | | | | | | | | | | | | | | | | | | | | | | | | | | | | | | | | | | | | | | | | | | | | | | | | | | | | | | | | | | | | | | | | | | | | | | | | | | | | | | | | | | | | | | | | | | | | | | | | | | | | | | | | | | | | | | | | | | | | | | | | | | | |
| 7 | 30:F7:C5:1D:3D:11 | N/A | Apple | guests | 6 | 83%(-57dBm) | 30 12 | | | | | | | | | | | | | | | | | | | | | | | | | | | | | | | | | | | | | | | | | | | | | | | | | | | | | | | | | | | | | | | | | | | | | | | | | | | | | | | | | | | | | | | | | | | | | | | | | | | | | | | | | | | | | | | | | | | | | | | | | | | | | | | | | | | | | | | | | | | | | | | | | | | | | | | | | | | | | | | | | | | | | | | | | | |
| 8 | 40:F0:2F:22:EB:A0 | N/A | LiteonTe | staffs | 6 | 34%(-76dBm) | 22 4 | | | | | | | | | | | | | | | | | | | | | | | | | | | | | | | | | | | | | | | | | | | | | | | | | | | | | | | | | | | | | | | | | | | | | | | | | | | | | | | | | | | | | | | | | | | | | | | | | | | | | | | | | | | | | | | | | | | | | | | | | | | | | | | | | | | | | | | | | | | | | | | | | | | | | | | | | | | | | | | | | | | | | | | | | | |
| 9 | 18:65:90:DE:D4:E5 | N/A | Apple | staffs_4F | 6 | 100%(-44dBm) | 0 0 | | | | | | | | | | | | | | | | | | | | | | | | | | | | | | | | | | | | | | | | | | | | | | | | | | | | | | | | | | | | | | | | | | | | | | | | | | | | | | | | | | | | | | | | | | | | | | | | | | | | | | | | | | | | | | | | | | | | | | | | | | | | | | | | | | | | | | | | | | | | | | | | | | | | | | | | | | | | | | | | | | | | | | | | | | |
| 10 | 60:45:CB:57:1F:36 | N/A | N/A | staffs_4F | 6 | 15%(-84dBm) | 0 0 | | | | | | | | | | | | | | | | | | | | | | | | | | | | | | | | | | | | | | | | | | | | | | | | | | | | | | | | | | | | | | | | | | | | | | | | | | | | | | | | | | | | | | | | | | | | | | | | | | | | | | | | | | | | | | | | | | | | | | | | | | | | | | | | | | | | | | | | | | | | | | | | | | | | | | | | | | | | | | | | | | | | | | | | | | |
| 11 | AC:5F:3E:62:E6:0D | N/A | Samsung | staffs_4F | 6 | 81%(-58dBm) | 0 0 | | | | | | | | | | | | | | | | | | | | | | | | | | | | | | | | | | | | | | | | | | | | | | | | | | | | | | | | | | | | | | | | | | | | | | | | | | | | | | | | | | | | | | | | | | | | | | | | | | | | | | | | | | | | | | | | | | | | | | | | | | | | | | | | | | | | | | | | | | | | | | | | | | | | | | | | | | | | | | | | | | | | | | | | | | |
| 12 | 50:BC:96:E0:00:11 | N/A | Apple | staffs | 6 | 71%(-62dBm) | 0 0 | | | | | | | | | | | | | | | | | | | | | | | | | | | | | | | | | | | | | | | | | | | | | | | | | | | | | | | | | | | | | | | | | | | | | | | | | | | | | | | | | | | | | | | | | | | | | | | | | | | | | | | | | | | | | | | | | | | | | | | | | | | | | | | | | | | | | | | | | | | | | | | | | | | | | | | | | | | | | | | | | | | | | | | | | | |
| 13 | 04:81:67:52:48:90 | Redmi5-mys... | N/A | staffs_4F | 6 | 45%(-72dBm) | 0 0 | | | | | | | | | | | | | | | | | | | | | | | | | | | | | | | | | | | | | | | | | | | | | | | | | | | | | | | | | | | | | | | | | | | | | | | | | | | | | | | | | | | | | | | | | | | | | | | | | | | | | | | | | | | | | | | | | | | | | | | | | | | | | | | | | | | | | | | | | | | | | | | | | | | | | | | | | | | | | | | | | | | | | | | | | | |
| 14 | 04:C2:3E:3F:CB:F8 | android-ac... | HTC | staffs_4F | 6 | 55%(-68dBm) | 0 0 | | | | | | | | | | | | | | | | | | | | | | | | | | | | | | | | | | | | | | | | | | | | | | | | | | | | | | | | | | | | | | | | | | | | | | | | | | | | | | | | | | | | | | | | | | | | | | | | | | | | | | | | | | | | | | | | | | | | | | | | | | | | | | | | | | | | | | | | | | | | | | | | | | | | | | | | | | | | | | | | | | | | | | | | | | |
| 15 | 0C:8B:FD:31:0B:78 | N/A | Intel | staffs_4F | 6 | 89%(-55dBm) | 2 2 | | | | | | | | | | | | | | | | | | | | | | | | | | | | | | | | | | | | | | | | | | | | | | | | | | | | | | | | | | | | | | | | | | | | | | | | | | | | | | | | | | | | | | | | | | | | | | | | | | | | | | | | | | | | | | | | | | | | | | | | | | | | | | | | | | | | | | | | | | | | | | | | | | | | | | | | | | | | | | | | | | | | | | | | | | |
| 16 | 58:48:22:EB:F8:62 | android-Sf... | Sony | staffs | 6 | 55%(-68dBm) | 0 0 | | | | | | | | | | | | | | | | | | | | | | | | | | | | | | | | | | | | | | | | | | | | | | | | | | | | | | | | | | | | | | | | | | | | | | | | | | | | | | | | | | | | | | | | | | | | | | | | | | | | | | | | | | | | | | | | | | | | | | | | | | | | | | | | | | | | | | | | | | | | | | | | | | | | | | | | | | | | | | | | | | | | | | | | | | |
| 17 | CC:9F:7A:63:11:27 | N/A | N/A | staffs_4F5... | 36 | 52%(-69dBm) | 0 0 | | | | | | | | | | | | | | | | | | | | | | | | | | | | | | | | | | | | | | | | | | | | | | | | | | | | | | | | | | | | | | | | | | | | | | | | | | | | | | | | | | | | | | | | | | | | | | | | | | | | | | | | | | | | | | | | | | | | | | | | | | | | | | | | | | | | | | | | | | | | | | | | | | | | | | | | | | | | | | | | | | | | | | | | | | |
| 18 | 20:47:DA:58:17:79 | RedmiNote5... | N/A | staffs_4F5... | 36 | 50%(-70dBm) | 0 0 | | | | | | | | | | | | | | | | | | | | | | | | | | | | | | | | | | | | | | | | | | | | | | | | | | | | | | | | | | | | | | | | | | | | | | | | | | | | | | | | | | | | | | | | | | | | | | | | | | | | | | | | | | | | | | | | | | | | | | | | | | | | | | | | | | | | | | | | | | | | | | | | | | | | | | | | | | | | | | | | | | | | | | | | | | |
| 19 | 70:81:EB:65:80:E5 | cheng | Apple | staffs_4F5... | 36 | 87%(-56dBm) | 0 0 | | | | | | | | | | | | | | | | | | | | | | | | | | | | | | | | | | | | | | | | | | | | | | | | | | | | | | | | | | | | | | | | | | | | | | | | | | | | | | | | | | | | | | | | | | | | | | | | | | | | | | | | | | | | | | | | | | | | | | | | | | | | | | | | | | | | | | | | | | | | | | | | | | | | | | | | | | | | | | | | | | | | | | | | | | |
| 20 | 8C:85:90:64:FE:A4 | N/A | Apple | staffs_4F5... | 36 | 36%(-75dBm) | 0 0 | | | | | | | | | | | | | | | | | | | | | | | | | | | | | | | | | | | | | | | | | | | | | | | | | | | | | | | | | | | | | | | | | | | | | | | | | | | | | | | | | | | | | | | | | | | | | | | | | | | | | | | | | | | | | | | | | | | | | | | | | | | | | | | | | | | | | | | | | | | | | | | | | | | | | | | | | | | | | | | | | | | | | | | | | | |

II-4-3 Mesh Discovery

Before a Mesh Node is connected, it is unable to check the device status from Mesh Root. This page can help to discover all Mesh devices around and offer the Link Status and Operation Mode of each Mesh device.

Mesh >> Mesh Discovery

Device List

| Index | MAC Address | Model | Operation Mode | Link Status |
|-------|-------------------|---------------|--------------------|-------------|
| 1 | 00:1D:AA:63:2C:00 | VigorAP920R | AP | |
| 2 | 00:1D:AA:3F:4F:B2 | VigorAP912C | AP | |
| 3 | 00:1D:AA:E4:8E:80 | VigorAP912C | AP | |
| 4 | 00:1D:AA:67:D6:40 | VigorAP1000C | AP | |
| 5 | 00:1D:AA:57:5D:38 | VigorAP1000C | MeshNode(Wireless) | New |
| 6 | 00:1D:AA:04:F0:DC | VigorAP1000C | MeshRoot | Connected |
| 7 | 00:50:7F:F1:92:16 | VigorAP903 | MeshRoot | Connected |
| 8 | 00:1D:AA:04:F0:6C | VigorAP1000C | MeshNode(Wireless) | Connected |
| 9 | 00:1D:AA:63:2C:10 | VigorAP920RPD | MeshNode(Wireless) | Connected |
| 10 | 00:1D:AA:72:E1:4A | VigorAP912C | AP | |
| 11 | 00:1D:AA:3F:4F:44 | VigorAP918RPD | MeshRoot | Connected |
| 12 | 00:50:7F:67:29:0C | VigorAP903 | MeshNode(Wireless) | Connected |

Scan

Note: During the scanning process (about 10 seconds), no station is allowed to connect with the AP and Mesh Network may disconnect.

For obtaining the list of devices around this VigorAP, click **Scan**. Later, surrounding VigorAP device(s) will be displayed on this page.

II-4-4 Basic Configuration Sync

If you add one Mesh Node in a mesh group, the Mesh Root will send the basic configuration to the device. This page could help you to change the Mesh Root settings and deliver the new configuration of the Mesh Root to all "connected" Mesh Nodes.

Mesh >> Basic Configuration Sync

Select All

System Maintenance

| Index | Name | Value |
|-------|--------------------------------------------------------|--------|
| 1 | ManagementServer.URL | |
| 2 | ManagementServer.Username | |
| 3 | ManagementServer.Password | ***** |
| 4 | ManagementServer.ConnectionRequestUsername | vigor |
| 5 | ManagementServer.ConnectionRequestPassword | ***** |
| 6 | ManagementServer.PeriodicInformEnable | 1 |
| 7 | ManagementServer.PeriodicInformInterval | 900 |
| 8 | X_00507F_System.Management.SkipQuickStartWizard | Enable |
| 9 | X_00507F_System.TR069Setting.CPEEnable | 0 |
| 10 | X_00507F_System.SyslogMail.SysLogAccess.SysLogEnable | 0 |
| 11 | X_00507F_System.SyslogMail.SysLogAccess.LogServerIP | |
| 12 | X_00507F_System.SyslogMail.SysLogAccess.LogServerPort | 514 |
| 13 | X_00507F_System.SyslogMail.SysLogAccess.LogLevel | All |
| 14 | X_00507F_System.SyslogMail.MailAlert.MailAlertEnable | 0 |
| 15 | X_00507F_System.SyslogMail.MailAlert.SMTPServer | |
| 16 | X_00507F_System.SyslogMail.MailAlert.MailTo | |
| 17 | X_00507F_System.SyslogMail.MailAlert.MailFrom | |
| 18 | X_00507F_System.SyslogMail.MailAlert.Username | |
| 19 | X_00507F_System.SyslogMail.MailAlert.Password | ***** |
| 20 | X_00507F_System.SyslogMail.MailAlert.UseTLS | 1 |
| 21 | X_00507F_System.SyslogMail.MailAlert.AdminLoginAlertEn | 1 |
| 22 | X_00507F_System.SyslogMail.MailAlert.SMTPServerPort | |

Wireless LAN (2.4GHz)

| Index | Name | Value |
|-------|-----------------------------------------------|---------------------|
| 1 | X_00507F_WirelessLAN_AP.General.EnableWLAN | 1 |
| 2 | X_00507F_WirelessLAN_AP.General.SSID.1.ESSID | ap960c-BandSteering |
| 3 | X_00507F_WirelessLAN_AP.General.SSID.1.Enable | 1 |

Available settings are explained as follows:

| Item | Description |
|------------------------------------------------------------------------|---------------------------------------------------------------------------------------------------------------------------------------------------------------------------------------------------------------------------------------------|
| System Maintenance / Wireless LAN (2.4Hz) / Wireless LAN (5GHz) | Check the item(s) you want to make configuration sync. Apply – Click it to apply the settings configured by such AP to all connected mesh node. Note that this button is available only when such AP is in mesh root mode. |

Tips for Mesh Network Setup

- Set up TWO mesh devices with uplink RSSI larger than -65dBm.
- Upgrade the firmware version of Mesh devices through Mesh link, starting from the mesh device with less hop number. For example, upgrade the firmware from the root, hop1 Mesh Node then hop2 Mesh Node, and so on.
- VigorMesh network supports up to 3 hops of mesh devices. However, it is suggested to connect the mesh group with less than or equals to 2 hops.

For your reference, we make a real mesh environment test and get the following record. (Use VigorAP APP to do internet speed test with different hops mesh node.)

Internet Download Speed (for root and hop1 ~ hop3):

iPad connects to Root : 80Mbps

iPad connects to hop1 Node : 49Mbps (Uplink RSSI : -55dBm)

iPad connects to hop2 Node : 41Mbps (Uplink RSSI : hop2 -64dBm / hop1 -55dBm)

iPad connects to hop3 Node : 26Mbps (Uplink RSSI : hop3 -62dBm / hop2 -68dBm / hop1 -55dBm)

- It is not suggested to use a wireless Mesh Node with Ethernet cable connected to a Mesh Root.
- If resetting a Mesh Root,
 - All "connected" Mesh Nodes will be informed to reset.
 - Group List and Group Key will be reset, too.
 - For those Mesh Nodes unable to reset, reset them manually. Reset the Group List by web or factory default.
- If resetting a Mesh Node,
 - Group List and Group Key will be cleared.
 - Link Status will become "New".
- Mesh network status also can be viewed and checked through the dashboard by clicking MESH NETWORK.

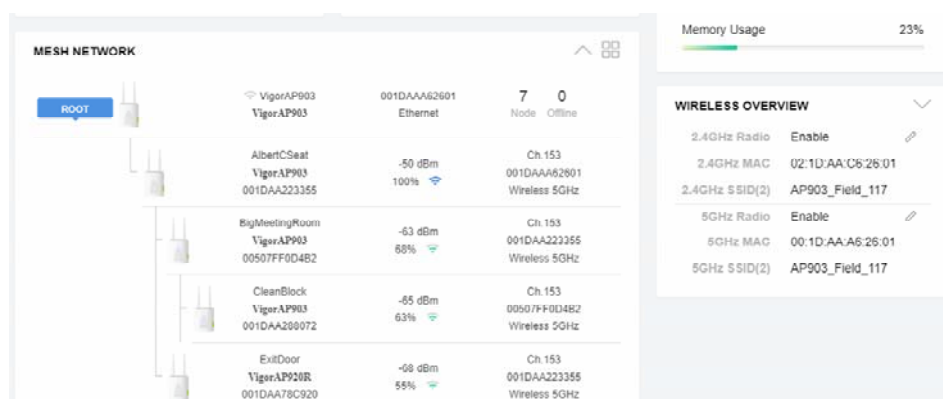

- If Mesh Search / Apply / Discover is worked too fast or is done with empty result, your request may be rejected. Please try again.
- Troubleshooting:
 - Check the firmware version. Please make sure all APs within the mesh group are in the newest firmware version.
 - Check the OP (operation) Mode. Make sure new Mesh Node doesn't accidentally get DHCP IP and becomes AP mode.
 - Check the country code and channels. For example, it is impossible for connecting a VigorAP 960C Mesh Root with 5G channel 36 to VigorAP920R Wireless Mesh Node in EU country code.
 - Check the channel load. Make sure it is not over 70%.

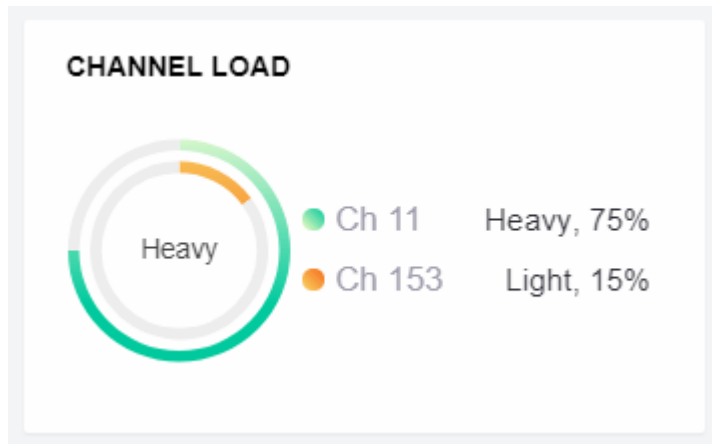

- Collect some Mesh logs and send the result to DrayTek for analyzing.

The screenshot shows the DrayTek Syslog Utility interface. The 'Log 過濾篩' (Log Filter) section has '關鍵字:' (Keywords) set to 'All' and '表用至:' (Applied to) set to 'All'. The 'APP' tab is selected, and the 'Mesh' sub-tab is active. The main log area displays a table of system logs.

| 系統時間 | 路由器時間 | 主機 | 訊息 |
|---------------------|----------------|--------|-----------------------------------------------------------------|
| 2018-11-08 19:01:16 | Nov 8 10:58:05 | syslog | [dnn] dnn_pkt_recv Announce-Keepalive |
| 2018-11-08 19:01:15 | Nov 8 10:58:04 | syslog | [dnn] dnn_pkt_send Alive |
| 2018-11-08 19:01:04 | Nov 8 10:57:52 | syslog | [dnn] dnn_pkt_send Alive |
| 2018-11-08 19:01:01 | Nov 8 10:57:50 | syslog | [dnn] dnn_pkt_recv Announce-Keepalive |
| 2018-11-08 19:00:59 | Nov 8 10:57:48 | kernel | [7525.323564] [dnn] Mesh IE Record (Isolate) 00:1D-AA:5C:A6:C8 |
| 2018-11-08 19:00:53 | Nov 8 10:57:41 | syslog | [dnn] dnn_pkt_send Alive |
| 2018-11-08 19:00:47 | Nov 8 10:57:36 | syslog | [dnn] dnn_pkt_recv Announce-Keepalive |
| 2018-11-08 19:00:41 | Nov 8 10:57:30 | syslog | [dnn] dnn_pkt_send Alive |
| 2018-11-08 19:00:39 | Nov 8 10:57:28 | kernel | [7505.200014] [dnn] Mesh IE Record (Isolate) 00:1D-AA:5C:A6:C8 |
| 2018-11-08 19:00:33 | Nov 8 10:57:22 | syslog | [dnn] dnn_pkt_recv Announce-Keepalive |
| 2018-11-08 19:00:30 | Nov 8 10:57:19 | syslog | [dnn] dnn_pkt_send Alive |
| 2018-11-08 19:00:19 | Nov 8 10:57:08 | syslog | [dnn] dnn_pkt_send Alive |
| 2018-11-08 19:00:18 | Nov 8 10:57:07 | syslog | [dnn] dnn_pkt_recv Announce-Keepalive |
| 2018-11-08 19:00:07 | Nov 8 10:56:56 | syslog | [dnn] dnn_pkt_send Alive |

II-4-5 Advanced Config Sync

If you add one Mesh Node in a mesh group, the Mesh Root will synchronize the advanced configuration to the device based on the setting results on this page.

Mesh >> Advanced Configuration Sync

Select All

Bridge VLAN to Mesh

| Index | Name | Value |
|-------|-------------------------------------------|---------|
| 1 | X_00507F_LAN.GeneralSetup.BridgeVLANtoWDS | Disable |

Roaming

| Index | Name | Value |
|-------|------------------------------------------------------------------------|--------------------------|
| 1 | X_00507F_WirelessLAN_AP.Roaming.APAClientRoaming.EnMinBasicRate | 0 |
| 2 | X_00507F_WirelessLAN_AP.Roaming.APAClientRoaming.MinBasicRate | 1Mbps |
| 3 | X_00507F_WirelessLAN_AP.Roaming.APAClientRoaming.RSSI | Disable_RSSI_Requirement |
| 4 | X_00507F_WirelessLAN_AP.Roaming.APAClientRoaming.StrictlyRSSISignal | 73 |
| 5 | X_00507F_WirelessLAN_AP.Roaming.APAClientRoaming.MinRSSISignal | 66 |
| 6 | X_00507F_WirelessLAN_AP.Roaming.APAClientRoaming.AdjacentRSSISignal | 5 |
| 7 | X_00507F_WirelessLAN_AP.Roaming.FastRoaming.Enable | 0 |
| 8 | X_00507F_WirelessLAN_AP.Roaming.FastRoaming.CachePeriod | 10 |
| 9 | X_00507F_WirelessLAN_5G_AP.Roaming.APAClientRoaming.EnMinBasicRate | 0 |
| 10 | X_00507F_WirelessLAN_5G_AP.Roaming.APAClientRoaming.MinBasicRate | 6Mbps |
| 11 | X_00507F_WirelessLAN_5G_AP.Roaming.APAClientRoaming.RSSI | Disable_RSSI_Requirement |
| 12 | X_00507F_WirelessLAN_5G_AP.Roaming.APAClientRoaming.StrictlyRSSISignal | 73 |
| 13 | X_00507F_WirelessLAN_5G_AP.Roaming.APAClientRoaming.MinRSSISignal | 66 |
| 14 | X_00507F_WirelessLAN_5G_AP.Roaming.APAClientRoaming.AdjacentRSSISignal | 5 |
| 15 | X_00507F_WirelessLAN_5G_AP.Roaming.FastRoaming.Enable | 0 |
| 16 | X_00507F_WirelessLAN_5G_AP.Roaming.FastRoaming.CachePeriod | 0 |

Advanced Setting

| Index | Name | Value |
|-------|--------------------------------------------------------|-------|
| 1 | X_00507F_WirelessLAN_AP.AdvancedSetting.ChannelList | |
| 2 | X_00507F_WirelessLAN_AP.AdvancedSetting.IGMPSnoopingEn | 1 |

Available settings are explained as follows:

| Item | Description |
|----------------------------|-------------------------------------------------------------|
| Select All | All item(s) will be selected for making configuration sync. |
| Bridge VLAN to Mesh | Check to transmit the packets with VLAN tag to mesh nodes. |

II-4-6 Support List

Mesh >> Support List

The following compatibility test lists Draytek AP models supported by this AP Mesh.

| Model | Status | Firmware Version |
|---------------|--------|------------------|
| VigorAP 802 | Y | 1.4.0 |
| VigorAP 903 | Y | 1.4.0 |
| VigorAP 912C | Y | 1.4.0 |
| VigorAP 918R | Y | 1.4.0 |
| VigorAP 920R | Y | 1.4.0 |
| VigorAP 960C | Y | 1.3.9 |
| VigorAP 1000C | Y | 1.3.5 |
| VigorAP 1060C | Y | 1.3.8 |

Y: Tested and is supported.

N: Not supported.

II-4-7 Mesh Syslog

Mesh >> Mesh Syslog

Mesh Log Information

| [Clear](#) | [Refresh](#) | [Line wrap](#) |

```
Oct 6 10:54:37 : [dmn] dmn_pkt_send Clone-v2
Oct 6 10:54:37 : [dmn] dmn_pkt_send Clone
Oct 6 10:54:37 : [dmn] dmn_pkt_send Clone-v2
Oct 6 10:54:37 : [dmn] dmn_pkt_send Clone
Oct 6 10:54:38 : [dmn] dmn_pkt_send Clone-v2
Oct 6 10:54:38 : [dmn] dmn_pkt_send Clone
Oct 6 10:54:39 : [dmn] dmn_pkt_send Clone-v2
Oct 6 10:54:39 : [dmn] dmn_pkt_send Clone
Oct 6 10:54:39 : [dmn] dmn_pkt_send Clone-v2
Oct 6 10:54:39 : [dmn] dmn_pkt_send Clone
Oct 6 10:54:39 : [dmn] dmn_pkt_send Clone-v2
Oct 6 10:54:39 : [dmn] dmn_pkt_send Clone
Oct 6 10:54:40 : [dmn] dmn_pkt_send Clone-v2
Oct 6 10:54:40 : [dmn] dmn_pkt_send Clone
Oct 6 10:54:41 : [dmn] dmn_pkt_send Clone-v2
Oct 6 10:54:41 : [dmn] dmn_pkt_send Clone
Oct 6 10:54:41 : [dmn] dmn_pkt_send Clone-v2
Oct 6 10:54:41 : [dmn] dmn_pkt_send Clone
Oct 6 10:54:42 : [dmn] dmn_pkt_send Clone-v2
```

II-5 Universal Repeater Settings for Range Extender Mode

When you choose **Range Extender** as the operation mode, the Wireless LAN menu items (for 2.4GHz and 5GHz) will include General Setup, Security, Access Control, WPS, Advanced Setting, AP Discovery, WDS AP Status, Universal Repeater, Airtime Fairness, Station Control, Roaming, Band Steering and Station List.

This section will introduce settings for Universal Repeater only.

For other wireless setting items (e.g., General Setup, Security, WPS, and etc.), please refer to II-3.

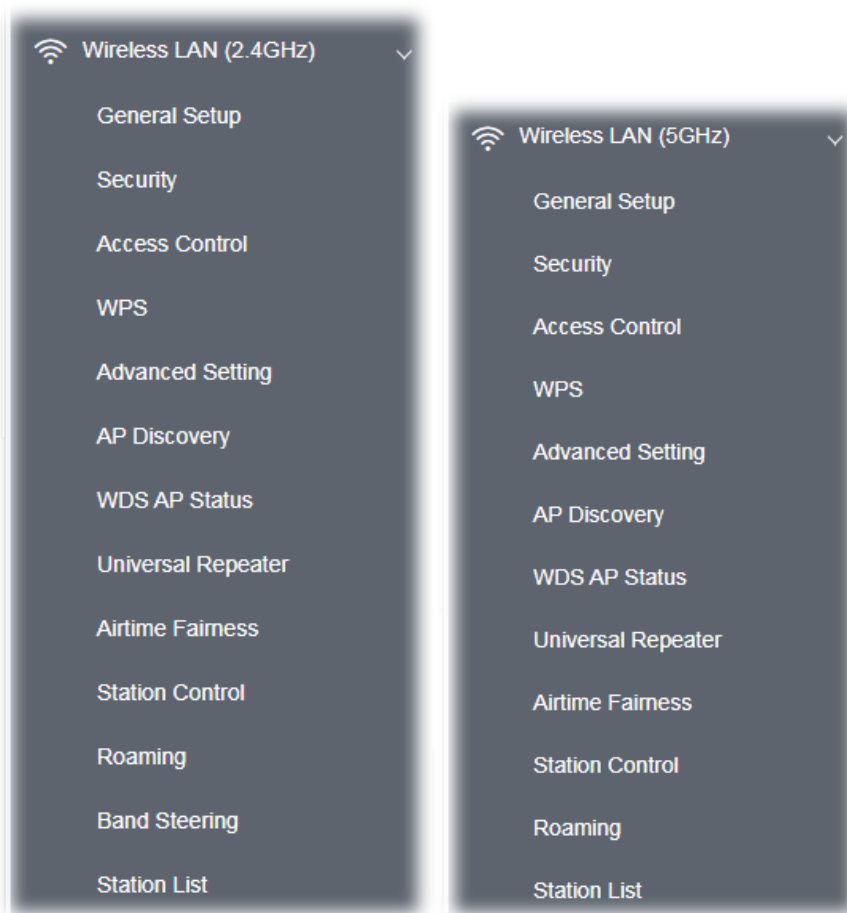

The following figure shows how VigorAP runs as Range Extender:



The access point can act as a wireless repeater; it can be Station and AP at the same time. It can use Station function to connect to a root AP and use AP function to serve all wireless stations within its coverage.

i Note:

While using **Universal Repeater** mode, the access point will demodulate the received signal. Please check if this signal is noise for the operating network, then have the signal modulated and amplified again. The output power of this mode is the same as that of AP mode.

Wireless LAN (2.4GHz) >> Universal Repeater

Universal Repeater Parameters

| | |
|------------------------|------------------------|
| SSID | <input type="text"/> |
| MAC Address (Optional) | <input type="text"/> |
| Channel | 2462MHz (Channel 11) ▾ |
| Security Mode | WPA2 Personal ▾ |
| Encryption Type | AES ▾ |
| Pass Phrase | <input type="text"/> |
| Range Extender Band | None |

Note: If Channel is modified, the Channel setting of AP would also be changed.

Universal Repeater IP Configuration

| | |
|-----------------|--------|
| Connection Type | DHCP ▾ |
| Device Name | AP960C |

OK Cancel

Available settings are explained as follows:

| Item | Description |
|--------------------------------------|---------------------------------------------------------------------------------------------------------------------------------------------------------------------------------------------------------------------------------------------------|
| Universal Repeater Parameters | |
| SSID | Display the SSID defined for Range Extender operation mode in Quick Start Wizard. Change the name of SSID whenever you want. |
| MAC Address (Optional) | Type the MAC address of access point that VigorAP 960C wants to connect to. |
| Channel | Means the channel of frequency of the wireless LAN. You may switch channel if the selected channel is under serious interference. If you have no idea of choosing the frequency, please select AutoSelect to let system determine for you. |
| Security Mode | There are several modes provided for you to choose. Each mode will bring up different parameters (e.g., WEP keys, Pass Phrase) for you to configure. |

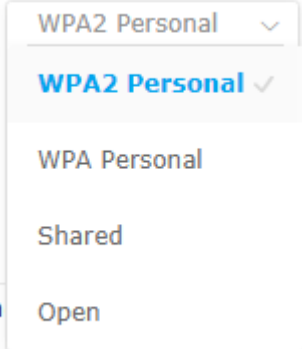
| | |
|-------------------------------------------------|-----------------------------------------------------------------------------------------------------------------------------------------------------------------------------------------------------------------------------------------------------------------------------------------------------------------------------------------------------------------------------------------------------------------------------------------------------------------------------------------------------------------------------------------------------------------------------------------------------------------------------------------------------------------|
| |  |
| Encryption Type for Open/Shared | <p>This option is available when Open/Shared is selected as Security Mode.</p> <p>Choose None to disable the WEP Encryption. Data sent to the AP will not be encrypted. To enable WEP encryption for data transmission, please choose WEP.</p> <p>WEP Keys - Four keys can be entered here, but only one key can be selected at a time. The format of WEP Key is restricted to 5 ASCII characters or 10 hexadecimal values in 64-bit encryption level, or restricted to 13 ASCII characters or 26 hexadecimal values in 128-bit encryption level. The allowed content is the ASCII characters from 33(!) to 126(~) except '#' and ','.</p> |
| Encryption Type for WPA/PSK and WPA2/PSK | <p>This option is available when WPA/PSK or WPA2/PSK is selected as Security Mode.</p> <p>Select TKIP or AES as the algorithm for WPA.</p> |
| Pass Phrase | <p>Type 8~63 ASCII characters, such as 012345678 (or 64 Hexadecimal digits leading by 0x, such as "0x321253abcde...").</p> |
| Range Extender Band | <p>Display the band number.</p> |
| Universal Repeater IP Configuration | |
| Connection Type | <p>Choose DHCP or Static IP as the connection mode.</p> <p>DHCP – The wireless station will be assigned with an IP from VigorAP.</p> <p>Static IP – The wireless station shall specify a static IP for connecting to Internet via VigorAP.</p> |
| Device Name | <p>This setting is available when DHCP is selected as Connection Type.</p> <p>Type a name for the VigorAP as identification. Simply use the default name.</p> |
| IP Address | <p>This setting is available when Static IP is selected as Connection Type.</p> <p>Type an IP address with the same network segment of the LAN IP setting of VigorAP. Such IP shall be different with any IP address in LAN.</p> |
| Subnet Mask | <p>This setting is available when Static IP is selected as Connection Type.</p> <p>Type the subnet mask setting which shall be the same as the one configured in LAN for VigorAP.</p> |
| Default Gateway | <p>This setting is available when Static IP is selected as Connection Type.</p> <p>Type the gateway setting which shall be the same as the default</p> |

| |
|----------------------------------------|
| gateway configured in LAN for VigorAP. |
|----------------------------------------|

After finishing this web page configuration, please click **OK** to save the settings.

II-6 LAN

Local Area Network (LAN) is a group of subnets regulated and ruled by modem.



II-6-1 General Setup

Click **LAN** to open the LAN settings page and choose **General Setup**.

i Note:

Such page will be changed according to the Operation Mode selected. The following screen is obtained by choosing AP as the operation mode.

LAN >> General Setup

Ethernet TCP / IP and DHCP Setup

| | |
|--------------------------------------------------------------------------------------------------------------------------------------------------------------------------------------------------------------------------------------------------------------------------------------------------------------------|----------------------------------------------------------------------------------------------------------------------------------------------------------------------------------------------------------------------------------|
| LAN IP Network Configuration <input checked="" type="checkbox"/> Enable DHCP Client IP Address: <input type="text" value="192.168.1.2"/> Subnet Mask: <input type="text" value="255.255.255.0"/> <input type="checkbox"/> Enable Management VLAN VLAN ID: <input type="text" value="0"/> | DHCP Server Configuration <input type="radio"/> Enable Server <input type="radio"/> Disable Server <input checked="" type="radio"/> Relay Agent DHCP Relay Agent: <input type="text" value="Server IP Address"/> |
| DNS Server IP Address Primary IP Address: <input type="text"/> Secondary IP Address: <input type="text"/> | |

OK

Cancel

Available settings are explained as follows:

| Item | Description |
|-------------------------------------|----------------------------------------------------------------------------------------------------------------------------------------------------------------------------------------------------------------------------------------------------------------------------------------------------------------------------------------------------------------------------------------------------------------------------------------------------------------------------------------------------------------------------------------------------------------------------------------------------------------------------------------------------------------------------------------------------------------------------------------------------------------------------------------------------------------------------------------------------------------------------------------------------------------------------------------------------------------------------------------------------------------------------------------------------------------------------------------------------------------------------------------------------------------------------------------------------------------------------------------------------------------------------------------------------------------------------------------------------------------------------------------------------------------------------------------------------------------------------------------------------------------------------------------------------------------------------------------------------------------------------------------------------------------------------------------------------------------------------------------------------------------------------------------------------------------------------------------------------------------------------------------------------------------------------------------------------------------------------------------------------------------------------------------------------------------------------------------------------------------------------------------------------------------------|
| LAN IP Network Configuration | <p>Enable DHCP Client – When it is enabled, VigorAP 960C will be treated as a client and can be managed / controlled by AP Management server offered by Vigor router (e.g., Vigor2860).</p> <p>IP Address – Type in private IP address for connecting to a local private network (Default: 192.168.1.2).</p> <p>Subnet Mask – Type in an address code that determines the size of the network. (Default: 255.255.255.0/ 24)</p> <p>Enable Management VLAN – VigorAP 960C supports tag-based VLAN for wireless clients accessing Vigor device. Only the clients with the specified VLAN ID can access into VigorAP 960C.</p> <ul style="list-style-type: none"> ● VLAN ID – Type the number as VLAN ID tagged on the transmitted packet. “0” means no VALN tag. |
| DHCP Server Configuration | <p>DHCP stands for Dynamic Host Configuration Protocol. DHCP server can automatically dispatch related IP settings to any local user configured as a DHCP client.</p> <p>Enable Server - Enable Server lets the modem assign IP address to every host in the LAN.</p> <ul style="list-style-type: none"> ● Start IP Address - Enter a value of the IP address pool for the DHCP server to start with when issuing IP addresses. If the 1st IP address of your modem is 192.168.1.2, the starting IP address must be 192.168.1.3 or greater, but smaller than 192.168.1.254. ● End IP Address - Enter a value of the IP address pool for the DHCP server to end with when issuing IP addresses. ● Subnet Mask - Type in an address code that determines the size of the network. (Default: 255.255.255.0/ 24) ● Default Gateway - Enter a value of the gateway IP address for the DHCP server. ● Lease Time - It allows you to set the leased time for the specified PC. ● Primary DNS Server - You must specify a DNS server IP address here because your ISP should provide you with usually more than one DNS Server. If your ISP does not provide it, the modem will automatically apply default DNS Server IP address: 194.109.6.66 to this field. ● Secondary DNS Server - You can specify secondary DNS server IP address here because your ISP often provides you more than one DNS Server. If your ISP does not provide it, the modem will automatically apply default secondary DNS Server IP address: 194.98.0.1 to this field. <p>Relay Agent - Specify which subnet that DHCP server is located the relay agent should redirect the DHCP request to.</p> <ul style="list-style-type: none"> ● DHCP Relay Agent - It is available when Enable Relay Agent is selected. Set the IP address of the DHCP server you are going to use so the Relay Agent can help to forward the DHCP request to the DHCP server. <p>Disable Server - Disable Server lets you manually or use other DHCP</p> |

| | |
|------------------------------|-------------------------------------------------------------------------------------------------------------------------------------------------------------------------------------------------------------------------------------------------------------------------------------------------------------------------------------------------------------------------------------------------------------------------------------------------------------------------------------------------------------------------------------------------------------------------------------------|
| | server to assign IP address to every host in the LAN. |
| DNS Server IP Address | <p>Primary DNS Server - You must specify a DNS server IP address here because your ISP should provide you with usually more than one DNS Server. If your ISP does not provide it, the modem will automatically apply default DNS Server IP address: 194.109.6.66 to this field.</p> <p>Secondary DNS Server - You can specify secondary DNS server IP address here because your ISP often provides you more than one DNS Server. If your ISP does not provide it, the modem will automatically apply default secondary DNS Server IP address: 194.98.0.1 to this field.</p> |

After finishing this web page configuration, please click **OK** to save the settings.

II-6-2 Hotspot Web Portal

The Hotspot Web Portal feature allows you to set up profiles so that LAN users could either be redirected to specific URLs, or be shown messages when they first connect to the Internet through the router. Users could be required to read and agree to terms and conditions, or authenticate themselves, prior to gaining access to the Internet. Other potential uses include the serving of advertisements and promotional materials, and broadcast of public service announcements.

Click **LAN** to open the LAN settings page and choose **Hotspot Web Portal**. Follow the on-screen steps to configure settings.

LAN >> Hotspot Web Portal

Hotspot Web Portal Profile:

| Index | Enable | Comments | Login Mode | Applied Interface |
|-------|--------------------------|----------|------------|-------------------|
| 1 | <input type="checkbox"/> | | None | |

Note: AP must connect to the Internet otherwise Web Page redirection won't work.

OK

Cancel

Click the index number (e.g., #1 in this case) to open the setting pages.

(1) Hotspot Web Portal Settings

LAN >> Hotspot Web Portal

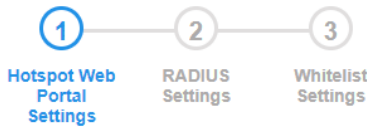

Hotspot Web Portal

Enable

Comments

Portal Server
Captive Portal URL
Redirection URL

Landing Page
Fixed URL

Applied Interfaces

LAN LAN (Works on Universal Repeater mode)

WLAN 2.4GHz

- SSID1 (DrayTek-426E1E)
- SSID2
- SSID3
- SSID4

WLAN 5GHz

- SSID1 (DrayTek-426E1E)
- SSID2
- SSID3
- SSID4

Note: AP must connect to the Internet otherwise Web Page redirection won't work.

Save and Next

Cancel

Available settings are explained as follows:

| Item | Description |
|---------------------------|--------------------------------------------------------------------------------------------------------------------------------------------------------------------------------------------------------------|
| Enable | Check it to enable the hotspot web portal settings. |
| Comments | Enter a brief description for this profile. |
| Portal Server | Captive Portal URL - Enter the captive portal URL. Redirection URL - Enter the URL to which the client will be redirected. |
| Landing page | Fixed URL - Enter the URL as the landing page for wireless clients. |
| Applied Interfaces | LAN - The current Hotspot Web Portal profile will be in effect for the selected LAN. SSID1 to SSID4 - The current Hotspot Web Portal profile will be in effect for the selected WLAN SSIDs. |
| Save and Next | Click to access into next page. |

After finishing this web page configuration, please click **Save and Next** for next setting page.

(2) RADIUS Settings

Configure the external RADIUS server for mutual authentication.

LAN >> Hotspot Web Portal

LAN >> Hotspot Web Portal

1 Hotspot Web Portal Settings 2 RADIUS Settings 3 Whitelist Settings

RADIUS Setup

Enable

Comments

Primary Server

Primary Server

Secret

Authentication Port

Retry times(1 ~ 3)

Advanced

NAS-Identifier

Note: Secret can contain only a-z A-Z 0-9 . < > + = \ | ? @ # ~ ` \$ % & / _ - * [] { } ' ^ ! ()

Back Save and Next Cancel

Available settings are explained as follows:

| Item | Description |
|-----------------------|-------------------------------------------------------------------------------------------------------------------------------------------------------------------------------------------------|
| Enable | Check it to enable the RADIUS server settings. |
| Comments | Enter a brief description for this profile. |
| Primary Server | Enter the IP address of RADIUS server. |
| Secret | The RADIUS server and client share a secret that is used to authenticate the messages sent between them. Both sides must be configured to use the same shared secret. The maximum length of the |

| | |
|----------------------------|----------------------------------------------------------------------------------------------------|
| | shared secret you can set is 36 characters. |
| Authentication Port | The UDP port number that the RADIUS server is using. The default value is 1812, based on RFC 2138. |
| Retry | Set the number of attempts to perform reconnection with RADIUS server. |
| NAS-Identifier | Enter a string as NAS identifier. |
| Back | Return to previous page. |
| Save and Next | Click to access into next page. |

After finishing this web page configuration, please click **Next** for next setting page.

(3) Whitelist Settings

Users are allowed to send and receive the traffic that satisfies whitelist settings. IPs under whitelist will not be redirected to other website (URL).

LAN >> Hotspot Web Portal

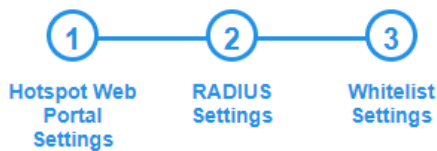

| Destination Domain | | | Destination IP | | |
|--------------------|-------------------------------------|-------------------------------------------|----------------|--------------------------|----------------------|
| Index | Enable | Domain Whitelist | Index | Enable | Domain Whitelist |
| 1 | <input checked="" type="checkbox"/> | <input type="text" value="192.168.1.11"/> | 2 | <input type="checkbox"/> | <input type="text"/> |
| 3 | <input checked="" type="checkbox"/> | <input type="text" value="192.168.1.12"/> | 4 | <input type="checkbox"/> | <input type="text"/> |
| 5 | <input type="checkbox"/> | <input type="text"/> | 6 | <input type="checkbox"/> | <input type="text"/> |
| 7 | <input type="checkbox"/> | <input type="text"/> | 8 | <input type="checkbox"/> | <input type="text"/> |

Available settings are explained as follows:

| Item | Description |
|---------------------------|---------------------------------------------------------------------------------------------------------|
| Destination Domain | |
| Enable | Check to enable the setting. |
| Domain Whitelist | Enter a domain (URL) / an IP address. |
| Destination IP | |
| Enable | Check to enable the setting. |
| IP Whitelist | LAN users with the IPs set in this page are able to access into Internet without entering other portal. |
| Back | Return to previous page. |

| | |
|---------------|-----------------------------|
| Finish | Click to save the settings. |
|---------------|-----------------------------|

After finishing this web page configuration, please click **Finish** to complete the configuration.

II-6-3 Port Control

To avoid wrong connection due to the insertion of unsuitable Ethernet cable, the function of physical LAN ports can be disabled via web configuration.

LAN >> Port Control

Port Control

Disable Port

OK

Cancel

Available settings are explained as follows:

| Item | Description |
|---------------------|----------------------------------------------------------------------------------------------------------------------|
| Disable Port | Check it to enable the port control. If it is enabled, you are allowed to disable the function of physical LAN port. |

After finishing this web page configuration, please click **OK** to save the settings.

Chapter III Management



III-1 System Maintenance

For the system setup, there are several items that you have to know the way of configuration: Status, TR-069, Administrator Password, Configuration Backup, Syslog/Mail Alert, Time and Date, SNMP, Management, Reboot System, and Firmware Upgrade.

Below shows the menu items for System Maintenance.

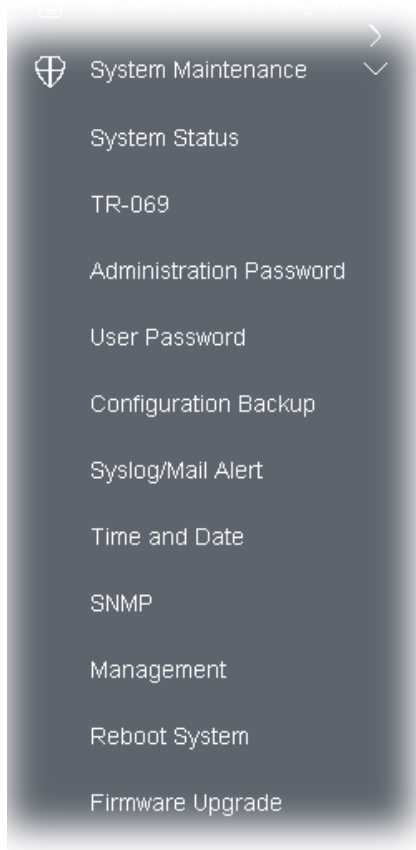

III-1-1 System Status

The **System Status** provides basic network settings of Vigor modem. It includes LAN and WAN interface information. Also, you could get the current running firmware version or firmware related information from this presentation.

System Status

```

Model          : VigorAP960C
Device Name    : VigorAP960C
Firmware Version : 1.4.0
Build Date/Time : g470_81a80a4fd8 Wed Feb 3 18:03:24 CST 2021
System Uptime  : 0d 02:49:34
Operation Mode : Range Extender
    
```

| System | |
|---------------|------------------------|
| Memory Total | : 425612 kB |
| Memory Left | : 187428 kB |
| Cached Memory | : 39512 kB / 425612 kB |

| LAN | |
|-------------|---------------------|
| MAC Address | : 14:49:BC:42:6E:1E |
| IP Address | : 192.168.1.2 |
| IP Mask | : 255.255.255.0 |

| Wireless LAN (2.4GHz) | |
|-----------------------|---------------------|
| MAC Address | : 14:49:BC:42:6E:1E |
| SSID | : DrayTek-426E1E |
| Channel | : 11 |
| Driver Version | : 10.4 |

| Wireless LAN (5GHz) | |
|---------------------|---------------------|
| MAC Address | : 14:49:BC:42:6E:1F |
| SSID | : DrayTek-426E1E |
| Channel | : 36 |
| Driver Version | : 10.4 |

WARNING: Your AP is still set to default password. You should change it via System Maintenance menu.

Each item is explained as follows:

| Item | Description |
|-----------------------------------|----------------------------------------------------------------------------|
| Model /Device Name | Display the model name of the modem. |
| Firmware Version | Display the firmware version of the modem. |
| Build Date/Time | Display the date and time of the current firmware build. |
| System Uptime | Display the period that such device connects to Internet. |
| Operation Mode | Display the operation mode that the device used. |
| System | |
| Memory total | Display the total memory of your system. |
| Memory left | Display the remaining memory of your system. |
| LAN | |
| MAC Address | Display the MAC address of the LAN Interface. |
| IP Address | Display the IP address of the LAN interface. |
| IP Mask | Display the subnet mask address of the LAN interface. |
| Wireless LAN (2.4GHz/5GHz) | |
| MAC Address | Display the MAC address of the WAN Interface. |
| SSID | Display the SSID of the device. |
| Channel | Display the channel that the station used for connecting with such device. |

III-1-2 TR-069

This device supports TR-069 standard. It is very convenient for an administrator to manage a TR-069 device (Vigor router, AP and etc.) through VigorACS (Auto Configuration Server).

System Maintenance >> TR-069 Settings

ACS Settings

URL Wizard

Username

Password

Test With Inform Event Code PERIODIC

Last Inform Response Time : ●

CPE Settings

Enable

SSL(HTTPS) Mode

URL

Port

Username

Password

Note : SSL(HTTPS) Mode only works when Vigor ACS SI is 1.1.6 and above version.

Periodic Inform Settings

Enable

Interval Time second(s)

STUN Settings

Enable Disable

Server Address

Server Port

Minimum Keep Alive Period second(s)

Maximum Keep Alive Period second(s)

OK Cancel

Available settings are explained as follows:

| Item | Description |
|---------------------|--------------------------------------------------------------------------------------------------------------------------------------------------------------------------------------------------------------------------------------------------------------------------------------------------------------------------------------------------------------------------------------------------------------------------------------------------------------------------------|
| ACS Settings | <p>Wizard – Click it to enter the IP address of VigorACS server host, port number and the handler.</p> <p>URL/Username/Password – Such data must be typed according to the ACS (Auto Configuration Server) you want to link. Please refer to Auto Configuration Server user’s manual for detailed information.</p> <p>Test With Inform – Click it to send a message based on the event code selection to test if such CPE is able to communicate with</p> |

| | |
|---------------------------------|----------------------------------------------------------------------------------------------------------------------------------------------------------------------------------------------------------------------------------------------------------------------------------------------------------------------------------------------------------------------------------------------------------------------------------------------------------------------------------------------------------------------------------------------------------------------------------------------------------------------------------------------------------------------------------------------------------------------------------------------------------------------------------------------------------------------|
| | <p>VigorACS SI server.</p> <p>Event Code – Use the drop down menu to specify an event to perform the test.</p> <p>Last Inform Response Time – Display the time that VigorACS server made a response while receiving Inform message from CPE last time.</p> |
| CPE Settings | <p>Such information is useful for Auto Configuration Server (ACS).</p> <p>Enable– Check the box to allow the CPE Client to connect with Auto Configuration Server.</p> <p>SSL(HTTPS) Mode - Check the box to allow the CPE client to connect with ACS through SSL.</p> <p>Port – Sometimes, port conflict might be occurred. To solve such problem, you might change port number for CPE.</p> <p>Username/Password – Type the username and password that VigorACS can use to access into such CPE.</p> |
| Periodic Inform Settings | <p>The default setting is Enable. Please set interval time or schedule time for the AP to send notification to VigorACS server.</p> <p>Interval Time – Type the value for the interval time setting. The unit is “second”.</p> |
| STUN Settings | <p>The default is Disable.</p> <p>If you click Enable, please type the relational settings listed below:</p> <p>Server Address – Type the IP address of the STUN server.</p> <p>Server Port – Type the port number of the STUN server.</p> <p>Minimum Keep Alive Period – If STUN is enabled, the CPE must send binding request to the server for the purpose of maintaining the binding in the Gateway. Please type a number as the minimum period. The default setting is “60 seconds”.</p> <p>Maximum Keep Alive Period – If STUN is enabled, the CPE must send binding request to the server for the purpose of maintaining the binding in the Gateway. Please type a number as the maximum period. A value of “-1” indicates that no maximum period is specified.</p> |

After finishing this web page configuration, please click **OK** to save the settings.

III-1-3 Administrator Password

This page allows you to set new password for accessing into web user interface of VigorAP.

System Maintenance >> Administration Password

Administrator Settings

| | |
|------------------------------------------------------------------------------------------------------------------------------------------------------------------------------------------------------------------------------------|-----------------------------------------------------------------------------------------------------------------|
| Account | <input type="text" value="admin"/> |
| Old Password | <input type="text"/> |
| New Password | <input type="text"/> |
| Confirm Password | <input type="text"/> |
| Password Strength: | <input type="button" value="Weak"/> <input type="button" value="Medium"/> <input type="button" value="Strong"/> |
| Strong password requirements: 1. Have at least one upper-case letter and one lower-case letter. 2. Including non-alphanumeric characters is a plus. | |
| Note : Authorization Account can contain only a-z A-Z 0-9 , ~ ` ! @ \$ % ^ * () _ + = { } [] ; < > . ? Authorization Password can contain only a-z A-Z 0-9 , ~ ` ! @ # \$ % ^ & * () _ + = { } [] \ ; < > . ? / | |
| <input type="button" value="OK"/> <input type="button" value="Cancel"/> | |

Available settings are explained as follows:

| Item | Description |
|--------------------------|--------------------------------------------------------------------------------------------------------------------------------------|
| Account | Enter the name for accessing into web user Interface. |
| Old Password | Enter the old password for accessing into the web user interface. |
| New Password | Enter in new password in this filed. |
| Confirm Password | Enter the new password again for confirmation. |
| Password Strength | The system will display the password strength (represented with the word of weak, medium or strong) of the password specified above. |

When you click **OK**, the login window will appear. Please use the new password to access into the web user interface again.

III-1-4 User Password

This page allows you to set new account and password for accessing the web pages under User Mode.

System Maintenance >> User Password

User Password

Enable User Mode

Account

Password

Confirm Password

Note: Authorization Account can contain only a-z A-Z 0-9 , ~ ` ! @ \$ % ^ * () _ + = { } [] | ; < > . ?
Authorization Password can contain only a-z A-Z 0-9 , ~ ` ! @ # \$ % ^ & * () _ + = { } [] \ ;
< > . ? /

Available settings are explained as follows:

| Item | Description |
|-------------------------|--------------------------------------------------------------------------------------------------------------------------------------------------------------------------------------------------------------------------------------------------------------------------|
| Enable User Mode | After checking this box, you can access into the web user interface with the password typed here for simple web configuration. The settings on simple web user interface will be different with full web user interface accessed by using the administrator password. |
| Account | Enter a user name. |
| Password | Enter in new password in this field. The length of the password is limited to 31 characters. |
| Confirm Password | Enter the new password again. |

Click **OK** to save the settings.

Settings to be configured in User Mode will be less than settings in Admin Mode. Only basic configuration settings will be available in User Mode.

III-1-5 Configuration Backup

Such function can be used to backup/restore the VigorAP 960C settings.

System Maintenance >> Configuration Backup

Configuration Backup / Restoration

Restoration

Select a configuration file.

Please enter the password and click Restore to upload the configuration file.

Password (optional):

Note: 1. You will need the same password to do configuration restoration.
2. The configuration file from the supported model list would be adopted.

Backup

Please specify a password and click Backup to download current configuration as an encrypted file.

Protect with password

Password (Max. 23 characters allowed)

Confirm Password

Note: Password can contain only a-z A-Z 0-9 , ! @ \$ % ^ _ - + = { } [] . ? /

Available settings are explained as follows:

| Item | Description |
|--------------------|-------------------------------------------------------------------------------------------------------------------------------------------------------------------------------------------------------------------------------------------------------------------------------------------------------------------------------------------------------------------------------------------------------------------------------------------|
| Restoration | <p>Browse - Click it to specify a file to be restored.</p> <p>Password (optional) - Enter a password for configuration restoration.</p> <p>Restore - Click it to restore the configuration file to VigorAP.</p> |
| Backup | <p>Perform the configuration backup of this device.</p> <p>Protect with password- For the sake of security, the configuration file for the access point can be encrypted.</p> <p>Password - Type several characters as the password for encrypting the configuration file.</p> <p>Confirm Password - Type the password again for confirmation.</p> <p>Backup - Click it to backup the configuration file.</p> |

Follow the steps below to backup your configuration.

1. Go to **System Maintenance >> Configuration Backup**.
2. If required, check the box of Protect with password and enter the password.
3. Click **Backup** to get into the following dialog. The configuration will download automatically to your computer as a file named **config.cfg**.

 **Note:**

Backup for Certification must be done independently. The Configuration Backup does not include information of Certificate.

Follow the steps below to restore your configuration.

1. Go to **System Maintenance >> Configuration Backup**.
2. Click **Upload** to choose the correct configuration file for uploading to the AP.
3. Click **Restore** and wait for few seconds.

III-1-6 Syslog/Mail Alert

SysLog function is provided for users to monitor AP. There is no bother to directly get into the Web user interface of the AP or borrow debug equipments.

System Maintenance >> Syslog / Mail Alert Setup

Syslog Access Setup

Enable

Server IP Address

Destination Port

Log Level

Mail Alert Setup

Enable

SMTP Server

SMTP Server Port

Mail To

Mail From

User Name

Password

Use TLS

Enable E-Mail Alert:

When Admin Login AP

Available settings are explained as follows:

| Item | Description |
|----------------------------|-----------------------------------------------------------------------------------------------------------------------------------------------------------------------------------------------------------------------------------------------------------------------------------------------------------------------------------------------------------------------------------------------------------------------------------------------------------------------------------------------------------|
| Syslog Access Setup | <p>Enable - Check Enable to activate function of Syslog.</p> <p>Server IP Address -The IP address of the Syslog server.</p> <p>Destination Port -Assign a port for the Syslog protocol. The default setting is 514.</p> <p>Log Level - Specify which level of the severity of the event will be recorded by Syslog.</p> |
| Mail Alert Setup | <p>Enable - Check Enable to activate function of mail alert.</p> <p>SMTP Server - The IP address of the SMTP server.</p> <p>SMTP Server Port - Set the port number for the SMTP server.</p> <p>Mail To - Assign a mail address for sending mails out.</p> <p>Mail From - Assign a path for receiving the mail from outside.</p> <p>User Name - Type the user name for authentication.</p> <p>Password - Type the password for authentication.</p> |

Use TLS – Check this box to encrypt alert mail. However, if the SMTP server specified here does not support TLS protocol, the alert mail with encrypted data will not be received by the receiver.

Enable E-Mail Alert - VigorAP will send an e-mail out when a user accesses into the user interface by using web or telnet.

When Admin Login AP – Enable/disable the function. When it is enabled, VigorAP will send out an e-mail to the recipient defined above when a user tries to access into VigorAP by entering login username and password.

Click **OK** to save the settings.

III-1-7 Time and Date

It allows you to specify where the time of VigorAP should be inquired from.

System Maintenance >> Time and Date

Time Information

| | | |
|---------------------|-------------------------|--------------|
| Current System Time | 2020 Oct 6 Tue 11:10:20 | Inquire Time |
|---------------------|-------------------------|--------------|

Time Setting

| | |
|-------------------------------------------------------|--------------------------------------|
| <input checked="" type="checkbox"/> Enable NTP Client | |
| Time Zone | (GMT+08:00) China Beijing, Chongqing |
| NTP Server | pool.ntp.org Use Default |
| Daylight Saving | <input type="checkbox"/> |
| NTP synchronization | 1 day |

OK Cancel

Available parameters are explained as follows:

| Item | Description |
|----------------------------|------------------------------------------------------------------------------------------------------------|
| Current System Time | Click Inquire Time to get the current time. |
| Enable NTP Client | Select to inquire time information from Time Server on the Internet using assigned protocol. |
| Time Zone | Select a time protocol. |
| NTP Server | Type the IP address of the time server. Use Default – Click it to choose the default NTP server. |
| Daylight Saving | Check the box to enable the daylight saving. Such feature is available for certain area. |
| NTP synchronization | Select a time interval for updating from the NTP server. |

Click **OK** to save these settings.

III-1-8 SNMP

This page allows you to configure settings for SNMP and SNMPV3 services.

The SNMPv3 is **more secure than** SNMP through the authentication method (support e.g., MD5) for the management needs.

System Maintenance >> SNMP

SNMP Agent

| | |
|-------------------------------------------------------------------|--------------------------------------|
| <input checked="" type="checkbox"/> Enable SNMPv1 / SNMPv2c Agent | |
| Get Community | <input type="text" value="public"/> |
| <input checked="" type="checkbox"/> Enable SNMPv3 Agent | |
| USM User | <input type="text"/> |
| Auth Algorithm | <input type="text" value="No Auth"/> |
| Auth Password | <input type="password"/> |

Note: SNMP V1/V2c is read-only and SNMP V3 is read-write.

Available settings are explained as follows:

| Item | Description |
|----------------------------|-----------------------------------------------------------------------------------------------------------------------------------------------------------|
| Enable SNMP Agent | Check it to enable this function. |
| Enable SNMPV3 Agent | Check it to enable this function. |
| USM User | USM means user-based security mode. Type a username which will be used for authentication. The maximum length of the text is limited to 23 characters. |
| Auth Algorithm | Choose one of the encryption methods listed below as the authentication algorithm. |
| Auth Password | Type a password for authentication. The maximum length of the text is limited to 23 characters. |

Click **OK** to save these settings.

III-1-9 Management

This page allows you to specify the port number for HTTP and HTTPS server.

System Maintenance >> Management

Device Name

Access Control

Enable Telnet Server

Disable Reset Button

Port Setup

HTTP Port (Default:80)

HTTPS Port (Default:443)

TLS Encryption Setup

TLSv1.3

TLSv1.2 or above

TLSv1.1 or above

TLSv1.0 or above

Panel Control

Disable LED

Enable Default Configuration Wizard

Available parameters are explained as follows:

| Item | Description |
|---------------------------------|----------------------------------------------------------------------------------------------------------------------------------------------------------------------------------------------------------------------------------------------------------------------------------------------------------------------------------------------------------------------------------------------------------------------------------------------------------------------------|
| Device Name | The default setting is VigorAP 960C. Change the name if required. |
| Access Control | <p>Enable Telnet Server- The administrator / user can access into the command line interface of VigorAP remotely for configuring settings.</p> <p>Disable Reset Button - If enabled, the function of the Reset button will be invalid.</p> |
| Port Setup | HTTP port/HTTPS port -Specify user-defined port numbers for the HTTP and HTTPS servers. |
| TLS/SSL Encryption Setup | Select to enable the function of TLS 1.0/1.1/1.2/1.3 if required. Due to security consideration, the built-in HTTPS and SSL VPN server of the router had upgraded to TLS1.x protocol. |
| Panel Control | <p>Disable LED - The LEDs blink always since VigorAP is powered on. Some people might not like that. Therefore the function of LED is allowed to be disabled to make people feeling comfortable and undisturbed. After checking it, all the LEDs on VigorAP will light off immediately after clicking OK.</p> <p>Enable Default Configuration Wizard - Default setting is enabled. When it is enabled, you will be guided into Quick Start Wizard</p> |

whenever clicking the DrayTek logo on the top of the web user interface.

The function will be disabled if you have configured Operation Mode, WLAN>>General Setup, WLAN>>Station Control or System Maintenance>>Administration Password.

Click **OK** to save these settings.

III-1-10 Reboot System

The web user interface may be used to restart your modem. Click **Reboot System** from **System Maintenance** to open the following page.

System Maintenance >> Reboot System

Reboot System

Do You want to reboot your AP ?

Using current configuration

Using factory default configuration

OK

If you want to reboot the modem using the current configuration, check **Using current configuration** and click **OK**. To reset the modem settings to default values, check **Using factory default configuration** and click **OK**. The modem will take 5 seconds to reboot the system.

i Note:

When the system pops up Reboot System web page after configuring the web settings, please click **OK** to reboot your device for ensuring normal operation and preventing unexpected errors of the modem in the future.

III-1-11 Firmware Upgrade

Before upgrading your modem firmware, you need to install the Modem Tools. The **Firmware Upgrade Utility** is included in the tools. The following web page will guide you to upgrade firmware by using an example. Note that this example is running over Windows OS (Operating System).

Download the newest firmware from DrayTek's web site or FTP site. The DrayTek web site is www.draytek.com (or local DrayTek's web site) and FTP site is [ftp.draytek.com](ftp://ftp.draytek.com).

Click **System Maintenance**>> **Firmware Upgrade** to launch the Firmware Upgrade Utility.

System Maintenance >> Firmware Upgrade

Firmware Update

Select a firmware file.

Click Upgrade to upload the file.

Firmware Version Status

[Refresh Latest Firmware](#)

| | |
|-----------------------------|---------|
| Current Firmware Version | : 1.4.0 |
| The Latest Firmware Version | : N/A |

Click **Download** to locate the newest firmware from your hard disk and click **Upgrade**.

System Maintenance >> Firmware Upgrade

Firmware Update

Firmware Upgrade is in progress... It must NOT be interrupted!



Firmware Version Status

[Refresh Latest Firmware](#)

| | |
|-----------------------------|---------|
| Current Firmware Version | : 1.3.3 |
| The Latest Firmware Version | : N/A |

III-2 Central AP Management

Such menu allows you to configure VigorAP device to be managed by Vigor router.

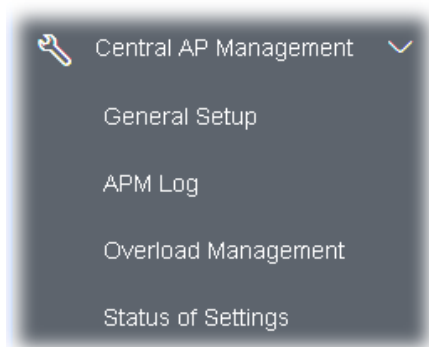

III-2-1 General Setup

Central AP Management >> General Setup

Management by VigorRouter / RootAP

- Enable NodeAP
- Enable Auto Provision

Manage other VigorAPs

- Enable RootAP

Note: RootAP cannot support AP700/AP800/AP900 as Node.
Maximum support 30 APs.

OK

Cancel

Available settings are explained as follows:

| Item | Description |
|------------------------------|------------------------------------------------------------------------------------------------------------------------------------------------------------------------------------------------------------------------------------------------------------------------------------------------------------------------------------------------------------------------------------------|
| Enable AP Management | Check the box to enable the function of AP Management (APM). |
| Enable Auto Provision | VigorAP 960C can be controlled under Central AP Management in Vigor router. When both Vigor router series and VigorAP 960C have such feature enabled, once VigorAP 960C is registered to Vigor router series, the WLAN profile pre-configured on Vigor router series will be applied to VigorAP 960C immediately. Thus, it is not necessary to configure VigorAP 960C separately. |
| Enable RootAP | Check this box to enable AP management. The role of this AP is "Root". |

Click **OK** to save these settings.

III-2-2 APM Log

This page will display log information related to wireless stations connected to VigorAP 960C and central AP management.

Such information also will be delivered to Vigor router (e.g., Vigor2862 or Vigor2926 series) and be shown on **Central AP Management>>Event Log** of Vigor router.

Central AP Management >> APM Log

APM Log Information

| [Clear](#) | [Refresh](#) | [Line wrap](#) |

```
Aug 24-13:02:54 syslog: [APM] Request done.
Aug 24-10:47:27 syslog: [APM] Get Traffic data.
Aug 24-10:47:27 syslog: [APM] Request done.
Aug 24-10:52:28 syslog: [APM] Get Traffic data.
Aug 24-10:52:28 syslog: [APM] Request done.
Aug 24-10:42:26 syslog: [APM] Get Traffic data.
Aug 24-10:42:26 syslog: [APM] Request done.
Aug 24-10:47:27 syslog: [APM] Get Traffic data.
Aug 24-10:47:27 syslog: [APM] Request done.
Aug 24-10:52:28 syslog: [APM] Get Traffic data.
Aug 24-10:52:28 syslog: [APM] Request done.
Aug 24-10:57:29 syslog: [APM] Get Traffic data.
Aug 24-10:57:29 syslog: [APM] Request done.
Aug 24-11:02:30 syslog: [APM] Get Traffic data.
Aug 24-11:02:30 syslog: [APM] Request done.
Aug 24-11:07:31 syslog: [APM] Get Traffic data.
```

III-2-3 Overload Management

Load Balance can help to distribute the traffic for all of the access points (e.g., VigorAP 960C) registered to Vigor router. Thus, the bandwidth will not be occupied by certain access points.

However, traffic overload might be occurred if too many wireless stations connected to VigorAP 960C for data incoming and outgoing. Therefore, "Force Overload Disassociation" is required to terminate the network connection of the client's station to release network traffic. When the function of "Force Overload Disassociation" in web user interface of Vigor router (e.g., Vigor2860 or Vigor2925 series) is enabled, wireless clients specified in **black list** of such web page will be disassociated to solve the problem of traffic overload.

The following web page is used to configure white list and black list for wireless stations.

Central AP Management >> Overload Management

Overload Management

MAC Address Filter of Force Overload Disassociation

| Index | MAC Address | Comment |
|-------------------|-------------|---------|
| White List | | |
| Black List | | |

Client's MAC Address : : : : : :

Apply to : White List ▾

Comment :

Note: When force overload disassociation is enabled, clients in black list will be disassociated first. Clients in white list will not be disassociated.

Available settings are explained as follows:

| Item | Description |
|------------------------------|-------------------------------------------------------------------------------------------------------------------------------------------------------------------------------------------------------------------------------------------------------------------------------------------|
| White List/Black List | Display the information (such as index number, MAC address and comment) for all of the members in White List/Black List. Wireless stations listed in Black List will be forcefully disconnected first when traffic overload occurs and "Force Overload Disassociation" is enabled. |
| Client's MAC Address | Specify the MAC Address of the remote/local client. |
| Apply to | White List – MAC address listed inside Client's MAC Address will be categorized as one of members in White List. |

| | |
|----------------|-------------------------------------------------------------------------------------------------------------------------|
| | Black List - MAC address listed inside Client's MAC Address will be categorized as one of members in Black List. |
| Comment | Type a brief description for the specified client's MAC address. |
| Add | Add a new MAC address into the White List/Black List. |
| Delete | Delete the selected MAC address in the White List/Black List. |
| Edit | Edit the selected MAC address in the White List/Black List. |
| Cancel | Give up the configuration. |

Click **OK** to save these settings.

III-2-4 Status of Settings

Load Balance can help to distribute the traffic for all of the access points (e.g., VigorAP 960Cs) registered to Vigor 2862 or Vigor2926 series. This web page displays the settings related to Load Balance for VigorAP 960C. In which, Station Number Threshold, Traffic Threshold and Force Overload Disassociation indicate settings configured in Vigor 2862 or Vigor2926 series.

Central AP Management >> Status of Settings

| Function Name | Status | Value |
|---------------------------------|--------|----------|
| Load Balance | | |
| Station Number Threshold | X | |
| Max WLAN(2.4GHz) Station Number | | 128 |
| Max WLAN(5GHz) Station Number | | 128 |
| Traffic Threshold | X | |
| Upload Limit | | None bps |
| Download Limit | | None bps |
| Force Overload Disassociation | X | |
| Disassociate By | | None |
| RSSI Threshold | | -50 dBm |
| Rogue AP Detection | | |
| Rogue AP Detection | X | |

"X" means the function is not enabled or VigorAP 960C has not registered to any Vigor router yet. Below shows a setting example for Load Balance settings configured in Vigor 2862 or Vigor2926 series.

Central Management >> AP >> Load Balance

AP Load Balance By Station Number or Traffic

Station Number Threshold

Wireless LAN (2.4GHz) (3-128)

Wireless LAN (5GHz) (3-128)

Traffic Threshold

Upload Limit bps (Default unit: K)

Download Limit bps (Default unit: K)

Action When Threshold Exceeded

Stop accepting new connections

Disassociate existing station by longest idle time

III-3 Mobile Device Management

Such feature can control / manage the mobile devices accessing the wireless network of VigorAP. VigorAP offers wireless LAN service for mobile device(s), PC users, MAC users or other users according to the policy selected.

Below shows the menu items for Mobile Device Management (MDM).

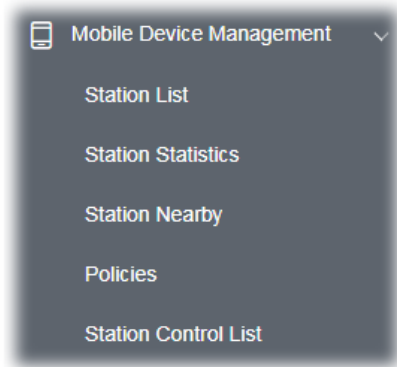

III-3-1 Station List

Station List provides the information related to the number of clients connecting to VigorAP, used bandwidth and the statistics of the AP device OS. Besides, users can create access control policies, device objects and set black & white list for

III-3-1-1 Connected Number

This page lists the graph for the number of wireless stations connected to this Access Point with different time phases.

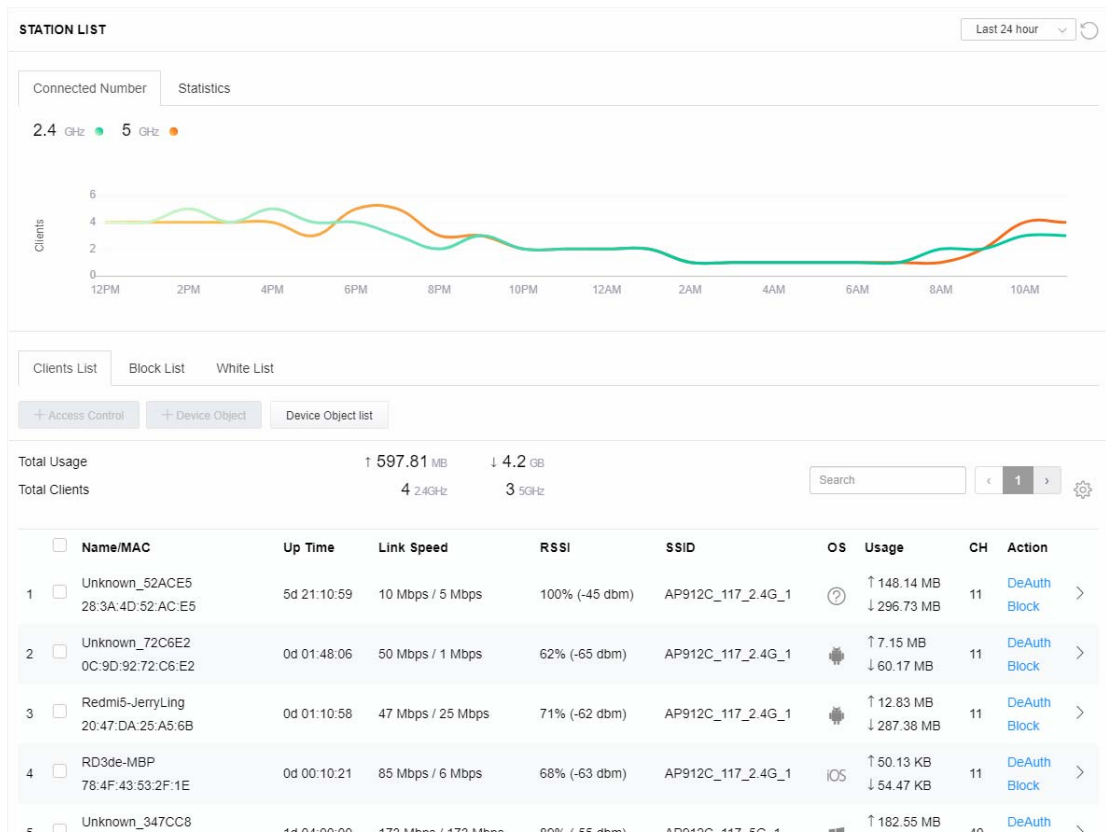

III-3-1-2 Statistics

The number of detected devices and the number of device(s) passed/blocked according to the policy specified in **Mobile Device Management>>Policy** can be illustrated as doughnut chart.

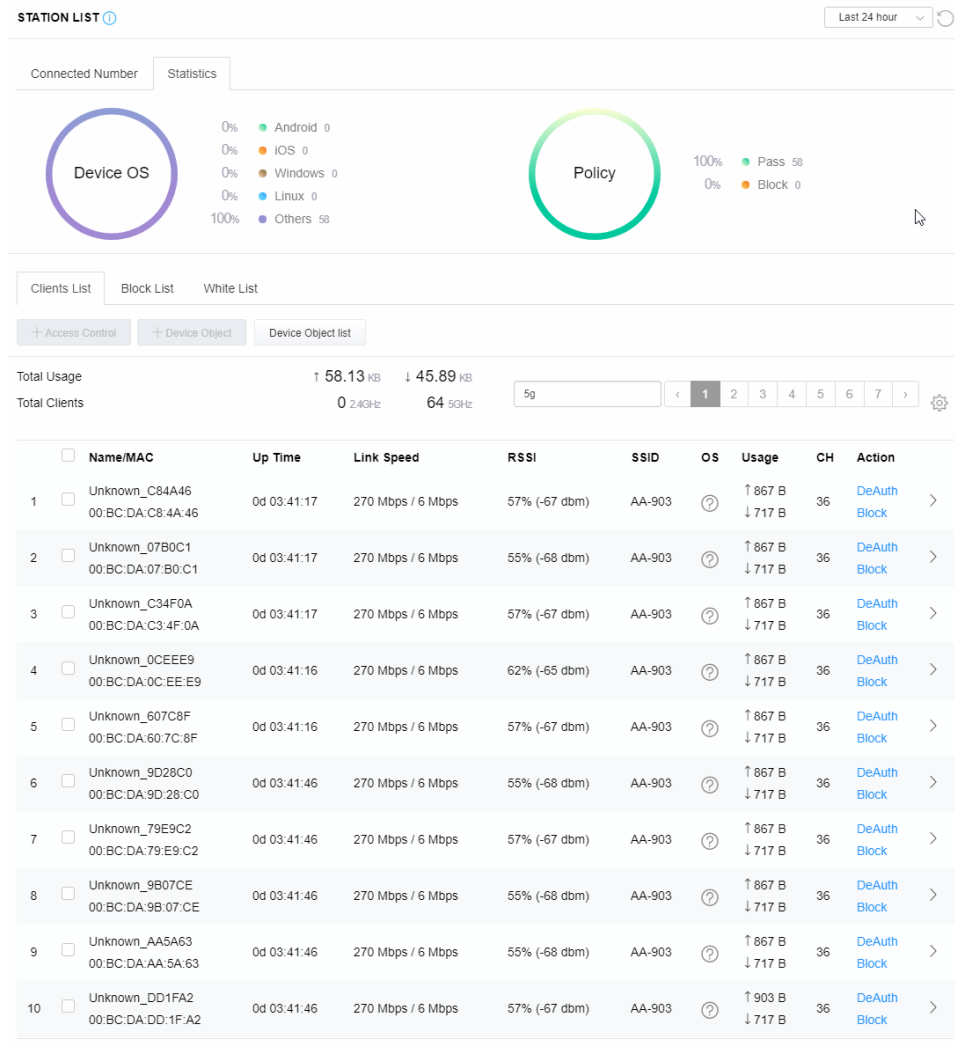

III-3-1-3 Clients List

The client list displays all the stations connecting to VigorAP.

STATION LIST ⓘ Last 24 hour ↻

Connected Number Statistics

Device OS

- 0% Android 0
- 0% iOS 0
- 0% Windows 0
- 0% Linux 0
- 100% Others 58

Policy

- 100% Pass 58
- 0% Block 0

Clients List Block List White List

+ Access Control
+ Device Object
Device Object list

Total Usage ↑ 58.13 KB ↓ 45.89 KB

Total Clients 0 2.4GHz 64 5GHz
5g
< 1 2 3 4 5 6 7 >
⚙️

| <input type="checkbox"/> | Name/MAC | Up Time | Link Speed | RSSI | SSID | OS | Usage | CH | Action |
|-------------------------------------|-------------------------------------|-------------|-------------------|---------------|--------|----|--------------------|----|-----------------|
| <input type="checkbox"/> | Unknown_C84A46 00:BC:DA:C8:4A:46 | 0d 03:42:47 | 270 Mbps / 6 Mbps | 57% (-67 dbm) | AA-903 | ? | ↑ 867 B ↓ 717 B | 36 | DeAuth Block |
| <input checked="" type="checkbox"/> | Unknown_07B0C1 00:BC:DA:07:B0:C1 | 0d 03:42:47 | 270 Mbps / 6 Mbps | 55% (-68 dbm) | AA-903 | ? | ↑ 867 B ↓ 717 B | 36 | DeAuth Block |
| <input checked="" type="checkbox"/> | Unknown_C34F0A 00:BC:DA:C3:4F:0A | 0d 03:42:47 | 270 Mbps / 6 Mbps | 57% (-67 dbm) | AA-903 | ? | ↑ 867 B ↓ 717 B | 36 | DeAuth Block |
| <input type="checkbox"/> | Unknown_0CEEE9 00:BC:DA:0C:EE:E9 | 0d 03:42:46 | 270 Mbps / 6 Mbps | 62% (-65 dbm) | AA-903 | ? | ↑ 867 B ↓ 717 B | 36 | DeAuth Block |

Available settings are explained as follows:

| Item | Description |
|------------------------|----------------------------------------------------------------------------------------------------------------------------------------------------------------------------------------------------------------------------------------------------------------------------------------------------------------------------------------------------------|
| +Access Control | <p>It is available after choosing one of the entries (clients) on Clients List.</p> <p>Wireless LAN - Specify the bandwidth for the access control list.</p> <p>SSID Policy - Set the policy for each SSID as black list or white list or disable.</p> <p>From to list - Display the clients available for applying this access</p> |

control.

Apply to SSID - Check **All** to make the device apply the policies to all SSIDs. Or select the one(s) to make the device apply the policies to the selected SSIDs.

Close - Exit this page without saving any changes.

Save changes - Save the changes and exit this page.

+Device Object

To add a device to device object list, choose one of the entries (clients) on Clients List to enable the Device Object button. Click the button to open the following page.

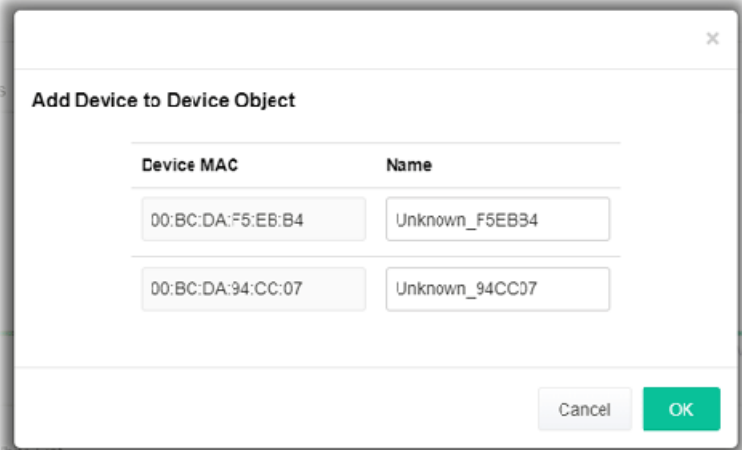

The screenshot shows a dialog box titled "Add Device to Device Object". It contains two rows of input fields. The first row has "Device MAC" as "00:BC:DA:F5:E6:B4" and "Name" as "Unknown_F5EB34". The second row has "Device MAC" as "00:BC:DA:94:CC:07" and "Name" as "Unknown_94CC07". At the bottom right, there are "Cancel" and "OK" buttons.

Check the information listed on the page. Change the MAC address or name of the selected entry if required. Then click **OK** and exit the page.

Device Object list

The existed device object profiles will be shown on the following page.



The screenshot shows a page titled "DEVICE OBJECT" with a section "Device Object Profiles". There is a search bar and a "Set to Factory Default" button. Below is a table with the following data:

| Profile | MAC | Name |
|---------|-------------------|--------|
| 1 | 00:50:7F:F1:91:BC | TEST_1 |
| 2 | 00:50:7F:00:52:BA | TEST_2 |

Clients List

Display the stations connecting to this Vigor device.

Total Usage - Display

Total Clients - Display the number of the clients using 2.4GHz

Name / MAC - Display the host name / MAC address of the connecting client.

Up Time - Display the connection time.

Link Speed- Display the link speed.

RSSI - Display the RSSI value.

SSID - Display the SSID the client used for connecting VigorAP.

OS - Display the OS of the client.

Usage - Display the bandwidth usage (up and down) of the client.

CH - Display the channel used by the client.

Action - Display the authentication method used by the client, and if it is on block list or white list.

III-3-1-4 Block List

This page displays information of the stations under block list.

STATION LIST ⓘ Last 24 hour ↻

Connected Number Statistics

2.4 GHz ● 5 GHz ●

Clients List Block List White List

+ Access Control + Device Object Device Object list

Search ⚙️

< 1 >

| | Name / MAC | SSID | Reason | Action |
|---|-------------------------------------|--------|--------|-------------------------|
| 1 | Unknown_457823 00:BC:DB:45:78:23 | AA-903 | ACL | Unblock |
| 2 | Unknown_A566C8 00:BC:DB:A5:66:C8 | AA-903 | ACL | Unblock |

Total list 2

Available settings are explained as follows:

| Item | Description |
|---------------------------|-------------------------------------------------------------------------------------------------------------------------------------------------------|
| Device Object list | Click it to open the Device Object List dialog for reference.  |
| Name / MAC | Display the host name / MAC Address for the connecting client. |
| SSID | Display the SSID that the wireless client connects to. |
| Reason | Display the reference information. |
| Action | Display the action that you can execute for the station. Unblock - Click to unblock the entry. |

III-3-1-5 White List

This page displays general information of the stations under white list.

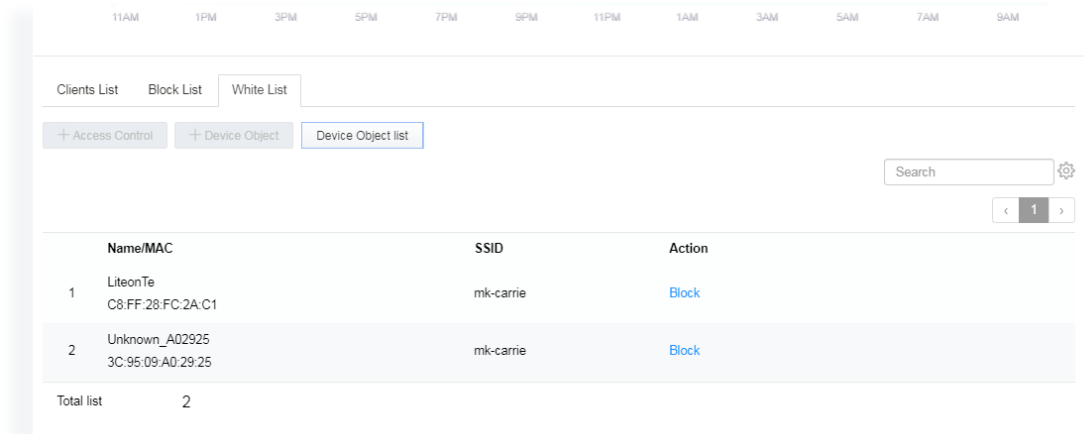

Available settings are explained as follows:

| Item | Description |
|---------------------------|------------------------------------------------------------------------------------------------------------------------------------------------------|
| Device Object list | Click it to open the Device Object List dialog for reference.  |
| Name / MAC | Display the host name / MAC Address for the connecting client. |
| SSID | Display the SSID that the wireless client connects to. |
| Action | Display the action that you can execute for the station. Block - Click to block the entry. |

III-3-2 Station Statistics

This page is used for debug or for the user to observe network traffic and network quality.

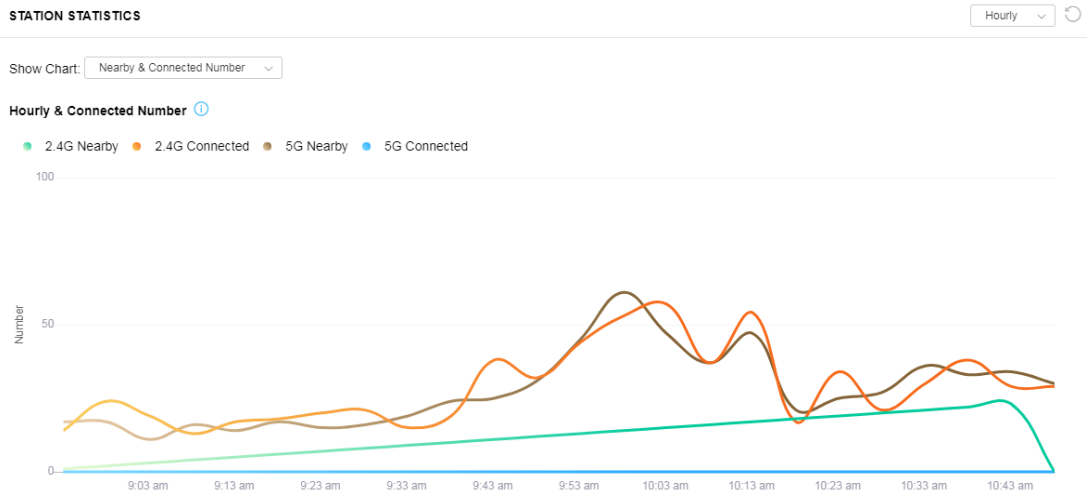

Available parameters are explained as follows:

| Item | Description |
|-------------------|-----------------------------------------------------------------------------------------------------------------------------------------------------------------------------------------------------------------------------------------------------------------------------------------------------------------------------------------------------------------------------------------------------------------------------------------------------------------------------------------------------------------------------|
| Show Chart | <p>Choose one of the items to display the statistics chart for wireless stations.</p> <p>Nearby & Connected Number - Choose it to have the statistics of the wireless stations which is nearby and connected to VigorAP 960C.</p> <p>Visiting & Passing Number - Choose it to have the statistics of the wireless stations which is visiting and passing to VigorAP 960C.</p> <p>Visiting Time - Choose it to have the statistics of the wireless stations which is visiting VigorAP 960C.</p> |

III-3-3 Station Nearby

This page displays the general information for the nearby stations.

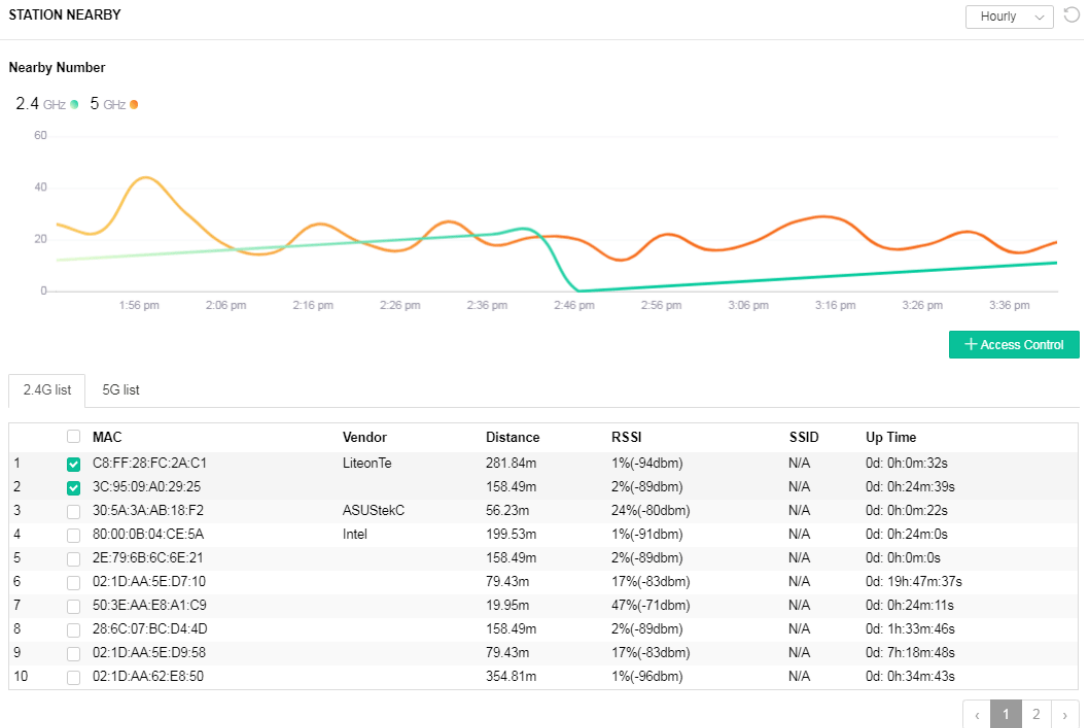

You can select the station(s) and click **+Access Control** to configure the nearby stations as the one(s) to pass through VigorAP or to be blocked by VigorAP.

The 'Add Access Control' dialog box is shown. It has a close button in the top right corner. The 'Wireless LAN' section has a dropdown menu set to '2.4GHz'. The 'SSID Policy' section has four dropdown menus, all set to 'Disable'. Below these are labels: 'ap912c-BandSteering', 'mk_carrie', 'N/A', and 'N/A'. The 'From to list' section has a table with columns for 'Device MAC', 'Name', and 'Apply to SSID'. The table contains one entry: '00:50:7F:35:F2:96' and 'DrayTek'. The 'Apply to SSID' column has checkboxes for 'All', '1', '2', '3', and '4', all of which are checked. At the bottom left, it says 'Total : 0/256'. At the bottom right, there are 'Close' and 'Save changes' buttons.

Available parameters are explained as follows:

| Item | Description |
|---------------------|----------------------------------------------------------------------------------------------------------------------------------------------------------------------------------------------------------------------------------------------------------------------------------------------------------------------------------------------------------------------------|
| SSID Policy | Determine the policy (disable, white list or black list) applied for the SSID (1 to 4). |
| From to list | <p>Device MAC - Display the MAC address of the selected station.</p> <p>Name - Display the name of the selected station.</p> <p>Apply to SSID - Check the box(es) to apply the SSID to the selected station.</p> <p>Close - Exit the dialog without saving the changes.</p> <p>Save changes - Save the changes and exit the dialog.</p> |

III-3-4 Policies

This page determines which devices (mobile, PC, MAC or others) allowed to make network connections via VigorAP or blocked by VigorAP.

Policies

Block Mobile Connections (OS:Android,iOS...)

Block PC Connections (OS:Windows,Linux,iMac...)

Block Unknown Connections (OS:Others)

WiFi(2.4GHz) SSID1 SSID2 SSID3 SSID4

WiFi(5GHz) SSID1 SSID2 SSID3 SSID4

Each item is explained as follows:

| Item | Description |
|----------------------------------|----------------------------------------------------------------------------------------------------------------|
| Block Mobile Connections | All of mobile devices will be blocked and not allowed to access into Internet via VigorAP. |
| Block PC Connections | All of network connections based on PC, MAC or Linux platform will be blocked and terminated. |
| Block Unknown Connections | Only the unknown network connections (unable to be recognized by Vigor router) will be blocked and terminated. |
| WiFi(2.4GHz) | Specify the SSID(s) to apply such policy. |
| WiFi(5GHz) | Specify the SSID(s) to apply such policy. |

After finished the policy selection, click **OK**. VigorAP will *reboot* to activate the new policy automatically.

III-3-5 Station Control List

This page displays information related to the wireless stations connecting to the Vigor AP.

STATION CONTROL LIST

 ● Online ○ Offline ↻

| | SSID | MAC | Connection Time | Reconnection Time |
|---|---------------------|-------------------|-----------------|-------------------|
| 1 | ● AP912C_117_2.4G_1 | 28:3A:4D:52:AC:E5 | 0d 00:58:50 | 0d 00:00:00 |
| 2 | ● AP912C_117_2.4G_1 | 20:47:DA:25:A5:6B | 0d 00:48:22 | 0d 00:00:00 |
| 3 | ● AP912C_117_5G_1 | 40:4E:36:5E:3F:A7 | 0d 00:59:55 | 0d 00:00:00 |
| 4 | ● AP912C_117_5G_1 | D0:37:45:34:7C:C8 | 0d 00:56:02 | 0d 00:00:00 |

ⓘ This page is available when [Station Control](#) is enabled.

This page is left blank.

Chapter IV Others

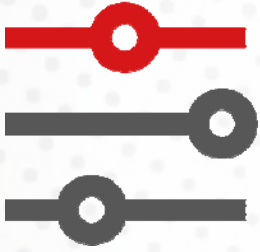

IV-1 RADIUS Setting

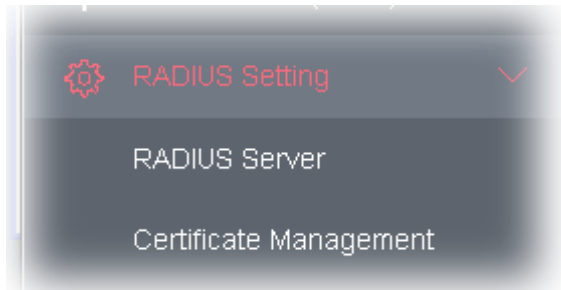

IV-1-1 RADIUS Server

VigorAP 960C offers a built-in RADIUS server to authenticate the wireless client that tries to connect to VigorAP 960C. The AP can accept the wireless connection authentication requested by wireless clients.

RADIUS Setting >> RADIUS Server Configuration

Enable RADIUS Server

Authentication Type

| | |
|------------------------|------|
| Radius EAP Type | PEAP |
|------------------------|------|

Users Profile (up to 96 users)

| Username | Password | Confirm Password | Configure |
|------------------------------------------------|-------------------------------------------|----------------------|--------------------------------------------------------------------------|
| <input type="text"/> | <input type="text"/> | <input type="text"/> | <input type="button" value="Add"/> <input type="button" value="Cancel"/> |
| NO. | Username | Select | |
| <input type="button" value="Delete Selected"/> | <input type="button" value="Delete All"/> | | |

Authentication Client (up to 16 clients)

| Client IP | Secret Key | Confirm Secret Key | Configure |
|------------------------------------------------|-------------------------------------------|----------------------|--------------------------------------------------------------------------|
| <input type="text"/> | <input type="text"/> | <input type="text"/> | <input type="button" value="Add"/> <input type="button" value="Cancel"/> |
| NO. | Client IP | Select | |
| <input type="button" value="Delete Selected"/> | <input type="button" value="Delete All"/> | | |

Backup Radius Cfg : Upload From File:

Available settings are explained as follows:

| Item | Description |
|------------------------------|----------------------------------------------------------------------------------------------------------------------------------------------------------------------------------------------------------------------------------------------------------------------------------------------------------------------------------------------------------------------------------------------------------------------------------------------------------------------------------------------------------------------------------------------------------------------------------------------------------------------------------------------------------------------------------------------------------------------------------------------------------------------------------------------------------------------------------------------------------------------------------------------------------------------------------------------------------------------------------------------------|
| Enable RADIUS Server | Check it to enable the internal RADIUS server. |
| Authentication Type | Let the user to choose the authentication method for RADIUS server. Radius EAP Type – There are two types, PEAP and EAP TLS, offered for selection. If EAP TLS is selected, a certificate must be installed or must be ensured to be trusted. |
| Users Profile | Username – Type a new name for the user profile. Password – Type a new password for such new user profile. Confirm Password – Retype the password to confirm it. Configure <ul style="list-style-type: none"> ● Add – Make a new user profile with the name and password specified on the left boxes. ● Cancel – Clear current settings for user profile. Delete Selected – Delete the selected user profile (s). Delete All – Delete all of the user profiles. |
| Authentication Client | This internal RADIUS server of VigorAP 960C can be treated as the external RADIUS server for other users. Specify the client IP and secret key to make the wireless client choosing VigorAP 960C as its external RADIUS server. Client IP – Type the IP address for the user to be authenticated by VigorAP 960C when the user tries to use VigorAP 960C as the external RADIUS server. Secret Key – Type the password for the user to be authenticated by VigorAP 960C while the user tries to use VigorAP 960C as the external RADIUS server. Confirm Secret Key – Type the password again for confirmation. Configure <ul style="list-style-type: none"> ● Add – Make a new client with IP and secret key specified on the left boxes. ● Cancel – Clear current settings for the client. Delete Selected – Delete the selected client(s). Delete All – Delete all of the clients. |
| Backup Radius Cfg | Backup - Click to store the configuration set on this page as a file. |
| Upload From File | Browse - Click to upload the RADIUS configuration file from the host to VigorAP. Restore - Click to restore the RADIUS configuration file to VigorAP. |

After finishing this web page configuration, please click **OK** to save the settings.

IV-1-2 Certificate Management

When the local client and remote server are required to make certificate authentication (e.g., Radius EAP-TLS authentication) for wireless connection and avoiding the attack of MITM, a trusted root certificate authority (Root CA) will be used to authenticate the digital certificates offered by both ends.

However, the procedure of applying digital certificate from a trusted root certificate authority is complicated and time-consuming. Therefore, Vigor AP offers a mechanism which allows you to

generate root CA to save time and provide convenience for general user. Later, such root CA generated by DrayTek server can perform the issuing of local certificate.

Root CA can be deleted but not edited. If you want to modify the settings for a Root CA, please delete the one and create another one by clicking Create Root CA.

RADIUS Setting >> X509 Trusted CA Certificate Configuration

| Name | Subject | Status | Modify |
|---------|---------|--------|----------------|
| Root CA | --- | --- | Create Root CA |

Note: 1. Please setup the "System Maintenance >> [Time and Date](#)" correctly before you try to generate a RootCA.
 2. The Time Zone MUST be setup correctly.

Click **Create Root CA** to open the following page. Type or choose all the information that the window request such as subject name, key type, key size and so on.

RADIUS Setting >> Create Root CA

| | |
|---------------------------|-------------------------------------------|
| Certificate Name | Root CA |
| Subject Name | |
| Country (C) | <input type="text"/> |
| State (S) | <input type="text"/> |
| Location (L) | <input type="text"/> |
| Organization (O) | <input type="text"/> |
| Organization Unit (OU) | <input type="text"/> |
| Common Name (CN) | <input type="text"/> |
| Email (E) | <input type="text"/> |
| Key Type | |
| | RSA <input type="button" value="v"/> |
| Key Size | |
| | 1024 Bit <input type="button" value="v"/> |
| Apply to Web HTTPS | |
| | <input type="checkbox"/> |

Available settings are explained as follows:

| Item | Description |
|---------------------|---------------------------------------------------------------------------------------------------------------------------------------------------------------------------------------------------------------------------------------------------------------------|
| Subject Name | Type the required information for creating a root CA. Country (C) – Type the country code (two characters) in this box. State (S)/ Location (L)/ Organization (O)/ Organization Unit (OU) /Common Name (CN) - Type the name or information for the root CA |

| | |
|---------------------------|-----------------------------------------------------------------------------------------------------------------------------------------------------------------------------------------------------------|
| | with length less than 32 characters. Email (E) – Type the email address for the root CA with length less than 32 characters. |
| Key Type | At present, only RSA (an encryption algorithm) is supported by such device. |
| Key Size | To determine the size of a key to be authenticated, use the drop down list to specify the one you need. |
| Apply to Web HTTPS | VigorAP needs a certificate to access into Internet via Web HTTPS. Check this box to use the user-defined root CA certificate which will substitute for the original certificate applied by web HTTPS. |

 Note:

“Common Name” must be configured with router’s WAN IP or domain name.

After finishing this web page configuration, please click **OK** to save the settings. A new root CA will be generated.

IV-2 Applications

Below shows the menu items for Applications.

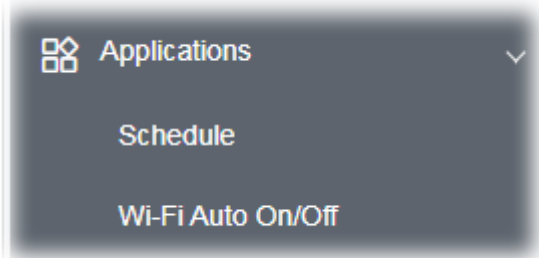

IV-2-1 Schedule

The VigorAP has a built-in clock which can update itself manually or automatically by means of Network Time Protocols (NTP). As a result, you can not only schedule the AP to dialup to the Internet at a specified time, but also restrict Internet access to certain hours so that users can connect to the Internet only during certain hours, say, business hours. The schedule is also applicable to other functions.

You have to set your time before set schedule. In **System Maintenance>> Time and Date** menu, press **Inquire Time** button to set the VigorAP's clock to current time of your PC. The clock will reset once if you power down or reset the AP. There is another way to set up time. You can inquiry an NTP server (a time server) on the Internet to synchronize the AP's clock. This method can only be applied when the WAN connection has been built up.

Applications >> Schedule

Schedule : Current System Time | [System time set](#) | [Set to Factory Default](#) |

| Index | Enable | Name | Action | Time | Frequency |
|-------|--------|------|--------|------|-----------------------------------------------------------------------------------------------|
| | | | | | <input type="radio"/> Active <input type="radio"/> Finished <input type="radio"/> Not reached |

Available settings are explained as follows:

| Item | Description |
|-------------------------------|-----------------------------------------------------------------------------------------|
| Current System Time | Display current system time. |
| System time set | Click it to open Time and Date page for configuring the time setting. |
| Set to Factory Default | Click it to return to the factory default setting and remove all the schedule profiles. |
| Index | Display the sort number of the schedule profile. |
| Enable | Check it to enable the function of schedule configuration. |
| Name | Display the name of the schedule. |
| Action | Display the action adopted by the schedule profile. |
| Time | Display the time setting of the schedule. |

| | |
|------------------|---------------------------------------------|
| Frequency | Display the frequency of the time schedule. |
|------------------|---------------------------------------------|

You can set up to **15** schedules. To add a schedule:

1. Check the box of **Enable Schedule**.
2. Click the **Add** button to open the following web page.

Applications >> Schedule

Add Schedule

Enable

Name

Start Date - - (Year - Month - Day)

Start Time : (Hour : Minute)

Duration Time : (Hour : Minute)

End Time : (Hour : Minute)

Action

WiFi(2.4GHz) Radio SSID2 SSID3 SSID4

WiFi(5GHz) Radio SSID2 SSID3 SSID4

How Often

Weekday Monday Tuesday Wednesday Thursday Friday Saturday

Sunday

Note: 1. If we set WiFi schedule "Start Time" and "End Time" at exact same time, AP will execute the schedule without an end time.
 2. "Internet Pause" will add Mac into ACL, so please make sure ACL isn't full before applying schedule.If ACL policy is "Disable", AP will change it to "Blocked".

Available settings are explained as follows:

| Item | Description |
|-------------------------------------|------------------------------------------------------------------------------------------------------------------------------------------------------------|
| Enable | Check to enable such schedule profile. |
| Start Date | Specify the starting date of the schedule. |
| Start Time | Specify the starting time of the schedule. |
| Duration Time | Specify the duration (or period) for the schedule. It is available only for the action set with WIFI UP, WIFI Down, or Internet Pause. |
| End Time | Display the ending time (sum of start time and duration time) of the schedule. |
| Action | Specify which action should apply the schedule. |
| WiFi(2.4GHz)/ WiFi(5GHz) | When Wi-Fi UP or Wi-Fi DOWN is selected as Action , you can check the Radio or SSID 2~4 boxes (2.4GHz and 5GHz respectively) to setup |

| | |
|------------------|-------------------------------------------------------------------------------------------------------------------------------------------------------------------------------------------------------------------------------------------------|
| | the network based on the schedule profile. Note: When Radio is selected, SSID2, SSID3 and SSID4 are not available for choosing, vice versa. Moreover, SSID2, SSID3, and SSID4 are not available for choosing if they are not enabled. |
| How Often | Specify how often the schedule will be applied. Once -The schedule will be applied just once Weekdays -Specify which days in one week should perform the schedule. |
| Weekday | Choose and check the day to perform the schedule. It is available when Weekdays is selected as How Often . |

- After finishing this web page configuration, please click **OK** to save the settings. A new schedule profile has been created and displayed on the screen.

Applications >> Schedule

Schedule : Current System Time | [System time set](#) | [Set to Factory Default](#) |

| Index | Enable | Name | Action | Time | Frequency | Active | Finished | Not reached |
|-------|-------------------------------------|--------|-------------|-------|-----------|----------------------------------|-----------------------|-----------------------|
| 1 | <input checked="" type="checkbox"/> | Formkt | Auto Reboot | 01:01 | Once | <input checked="" type="radio"/> | <input type="radio"/> | <input type="radio"/> |

IV-2-2 Wi-Fi Auto On/Off

When VigorAP is able or unable to ping the specified host, the Wi-Fi function will be turned on or off automatically. The purpose of such function is to avoid wireless station roaming to an AP which is unable to access Internet.

Applications >> Wi-Fi Auto On/Off

Wi-Fi Auto On/Off

Enable Auto Switch On/Off Wi-Fi

Ping Host

Auto Switch On/Off Wi-Fi:
Turn on/off the Wi-Fi automatically when the AP is able/unable to ping the host.

Available settings are explained as follows:

| Item | Description |
|----------------------------------------|--------------------------------------------------------------------------------------------------------------------------|
| Enable Auto Switch On/Off Wi-Fi | Check the box to enable such function. |
| Ping Host | Type an IP address (e.g., 8.8.8.8) or a domain name (e.g., google.com) for testing if the access point is stable or not. |

Click **OK** to save the settings.

IV-3 Objects Setting

Below shows the menu items for Objects Setting.

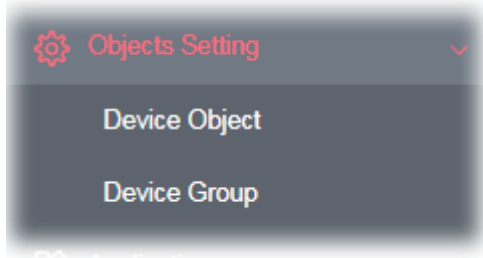

IV-3-1 Device Object

VigorAP can specify a client as a device object to be used by other applications.

Objects Setting >> Device Object

- [Create from Wireless Station Table](#)
- [Create from Wireless Neighbor Table](#)
- [Create from ARP Table](#)

| Device Object Profiles | | | | Set to Factory Default | |
|------------------------|-----|------|-------|----------------------------------------|------|
| Index | MAC | Name | Index | MAC | Name |
| 1 | | | 17 | | |
| 2 | | | 18 | | |
| 3 | | | 19 | | |
| 4 | | | 20 | | |
| 5 | | | 21 | | |
| 6 | | | 22 | | |
| 7 | | | 23 | | |
| 8 | | | 24 | | |
| 9 | | | 25 | | |
| 10 | | | 26 | | |
| 11 | | | 27 | | |
| 12 | | | 28 | | |
| 13 | | | 29 | | |
| 14 | | | 30 | | |
| 15 | | | 31 | | |
| 16 | | | 32 | | |

[<< 1-32](#) | [33-64](#) | [65-96](#) | [97-128](#) | [129-160](#) | [161-192](#) | [193-224](#) | [225-256 >>](#)
[Next >>](#)

Available settings are explained as follows:

| Item | Description |
|-------------------------------------------|---------------------------------------------------------------------------------------------------------------------------------------|
| Create from Wireless Station Table | <p>Click the link to open the following page.</p> <p>Choose the one(s) you want and click OK. The selected entries will be</p> |

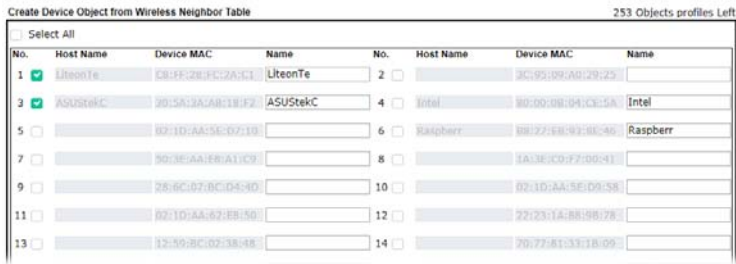
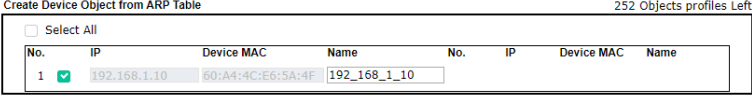
| | |
|--------------------------------------------|--------------------------------------------------------------------------------------------------------------------------------------------------------------------------------------------------------------------------------------------------------------------------------------------------------------|
| | listed on the Device Object Profiles. |
| Create from Wireless Neighbor Table | <p>Click the link to open the following page.</p> <p>Objects Setting >> Device Object</p>  <p>Choose the one(s) you want and click OK. The selected entries will be listed on the Device Object Profiles.</p> |
| Create from ARP Table | <p>Click the link to open the following page.</p> <p>Objects Setting >> Device Object</p>  <p>Choose the one(s) you want and click OK. The selected entries will be listed on the Device Object Profiles.</p> |
| Set to Factory Default | Click it to return to the factory default setting and remove all the device object profiles. |
| Index | Display the index number of device object profile. |
| MAC | Display the MAC address specified by the device object profile. |
| Name | Display the name of the device object profile. |
| Back ACL Cfg | Backup - Click to backup current configuration. |
| Upload From File | Browse - Click to upload the selected file onto Vigor device. Restore - Click to restore the configuration file with the selected file. |

In addition to choosing from the wireless station table, neighbor table or ARP table, you can click any index number link to create a new device object profile by entering the name and MAC address manually.

Objects Setting >> Device Object

Profile Index : 1

Name :

Mac Address :

Attribute : Isolate LAN exception

| Item | Description |
|------|-------------|
|------|-------------|

| | |
|--------------------|------------------------------------------------------|
| Name | Enter the name of the profile. |
| Mac Address | Enter the MAC address of the client. |
| Attribute | Check the box to ignore the function of Isolate LAN. |
| OK | Save the settings. |
| Clear | Remove the settings. |
| Cancel | Discard the settings and return to previous page. |

IV-3-2 Device Group

Clients can be integrated as a group and be used by other applications.

Objects Setting >> Device Group

Device Group Table [| Set to Factory Default |](#)

| Index | Name | Index | Name |
|--------------------|------|--------------------|------|
| 1 | | 17 | |
| 2 | | 18 | |
| 3 | | 19 | |
| 4 | | 20 | |
| 5 | | 21 | |
| 6 | | 22 | |
| 7 | | 23 | |
| 8 | | 24 | |
| 9 | | 25 | |
| 10 | | 26 | |
| 11 | | 27 | |
| 12 | | 28 | |
| 13 | | 29 | |
| 14 | | 30 | |
| 15 | | 31 | |
| 16 | | 32 | |

Backup ACL Cfg :
Upload From File:

Available settings are explained as follows:

| Item | Description |
|-------------------------------|----------------------------------------------------------------------------------------------------------------------------------------------------------|
| Set to Factory Default | Click it to return to the factory default setting and remove all the device group profiles. |
| Index | Display the index number of the device group profile. |
| Name | Display the name of the device group profile. |
| Back ACL Cfg | Backup - Click to backup current configuration. |
| Upload From File | Browse - Click to upload the selected file onto Vigor device. Restore - Click to restore the configuration file with the selected file. |

Click any index number link to create a new device group profile.

Profile Index : 1

Name :

Available Device Objects

3 - ASUSTekC

4 - 192_168_1_10

>>

<<

Selected Device Objects

1 - TEST_1

2 - LiteonTe

OK
Clear
Cancel

Available settings are explained as follows:

| Item | Description |
|---------------------------------|------------------------------------------------------------------------------------------------------------------------------------|
| Name | Enter the name of the new group profile. |
| Available Device Objects | Display current available device objects. Choose the one(s) and click the >> button to move them under the Selected IP Objects. |
| Selected Device Objects | Display the selected device objects. Choose the one(s) and click the << button to discard the selections. |
| OK | Save the settings. |
| Clear | Remove the settings. |
| Cancel | Discard the settings and return to previous page. |

Chapter V Mobile APP, DrayTek Wireless



V-1 Introduction of DrayTek Wireless

VigorAP AP903 supports Android/iOS APP : DrayTek Wireless. The mobile user can find the APP through Apple Store / Android APP.

After downloading the APP, a mobile user is able to access and login the configuration page of VigorAP. It can be used to set up or check status of VigorAP device in different Operation Mode.

- To access into the VigorAP configured previously, please refer to [**V-2 Select a VigorAP**](#)
- To access into a new installed VigorAP, please refer to [**V-3 Quick Start Wizard**](#)

Note:

Before using the DrayTek Wireless APP, please **ENABLE** your Wi-Fi feature first. Then, select the Wi-Fi network with Vigor access point(s) connected physically.

It is not necessary to connect to VigorAP physically. The mobile user must connect to one network with the same subnet as the VigorAP.

V-2 Select a VigorAP

1. Run DrayTek Wireless APP.

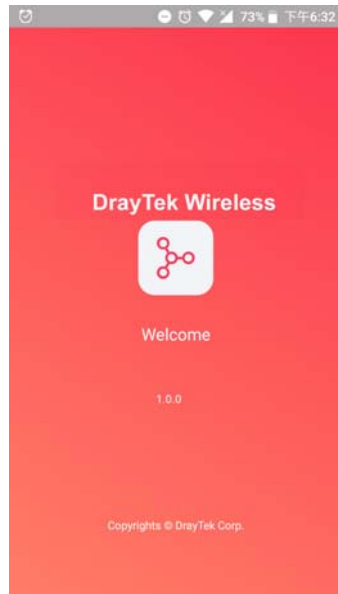

2. Choose one AP in the network by clicking the inverted triangle icon to open a drop down list.

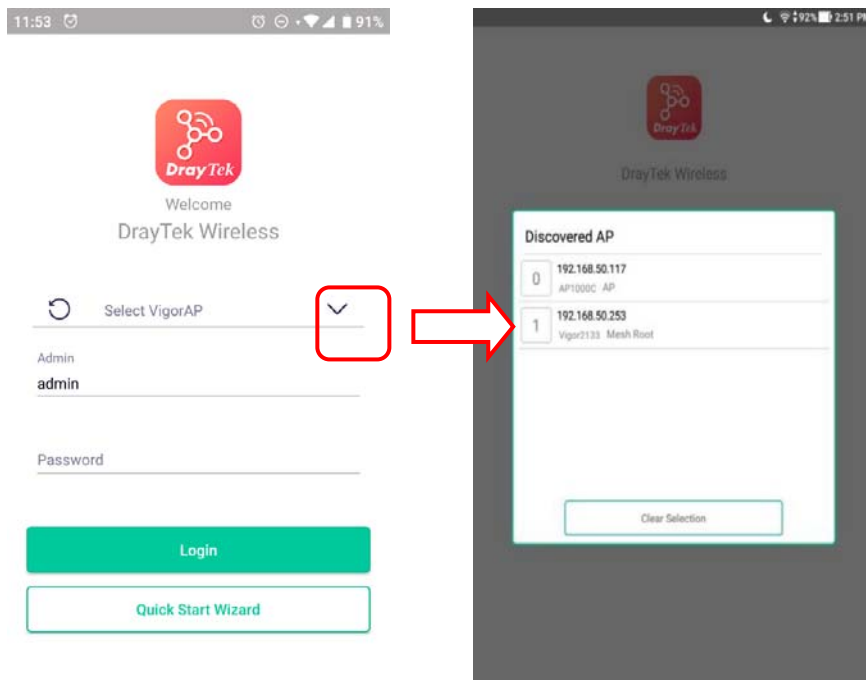

Available VigorAP devices with Model Name, IP and Operation mode of VigorAP found by DrayTek Wireless APP will be listed under **Discovered VigorAP**. Choose one of the devices to login (or use Quick Start Wizard function).

If no AP is found, Quick Start Wizard will start with Wi-Fi connection or start with wizard procedure directly.

V-3 Quick Start Wizard

Quick Start Wizard in Wireless APP is useful for connecting an new installed AP and configuring with different Operation Mode.

How to create a Mesh Group?

1. Click **Quick Start Wizard**.

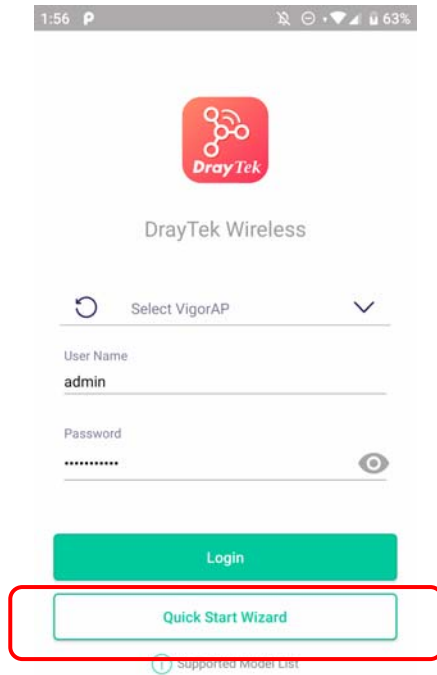

2. Under Quick Start Wizard, there are two methods to locate a mesh root, Search and Scan,
 - Click **Scan** to scan the QR code printed on VigorAP packaging box to connect the designated VigorAP.

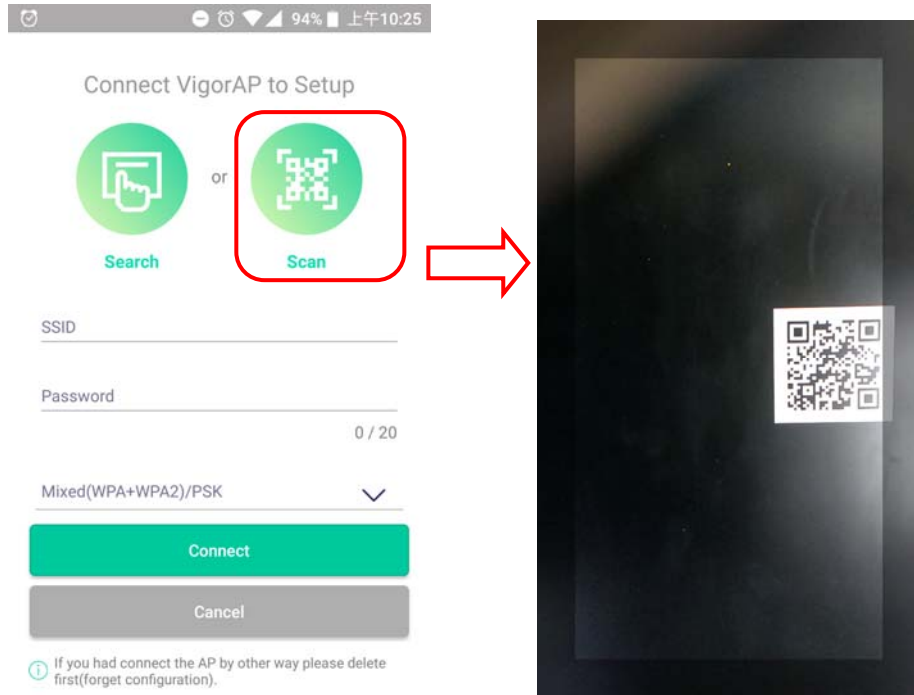

- Or, click **Search**. When the searching result appears, choose one of the AP devices to connect.

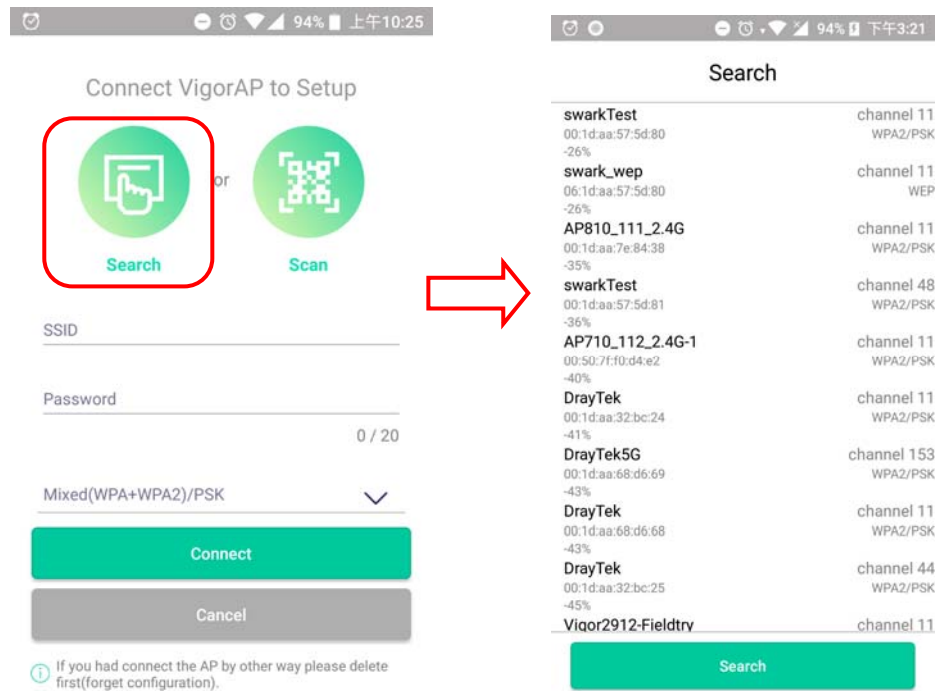

- When the following page appears, enter the password for the VigorAP device. Then, click **Connect**.

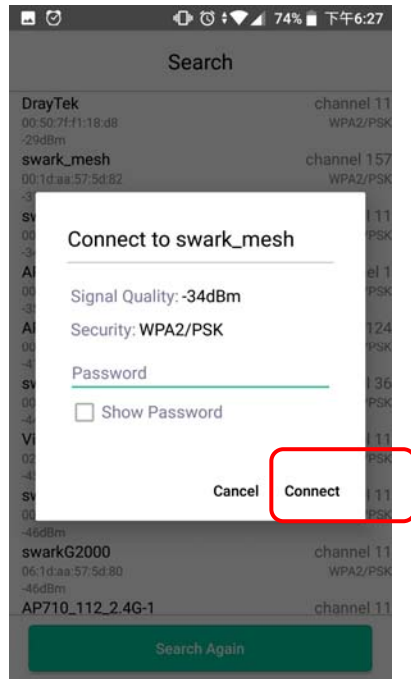

- When the connection is successful, click **Next**. Then, set Operation Mode of VigorAP as **Mesh Root** and click **Next**.

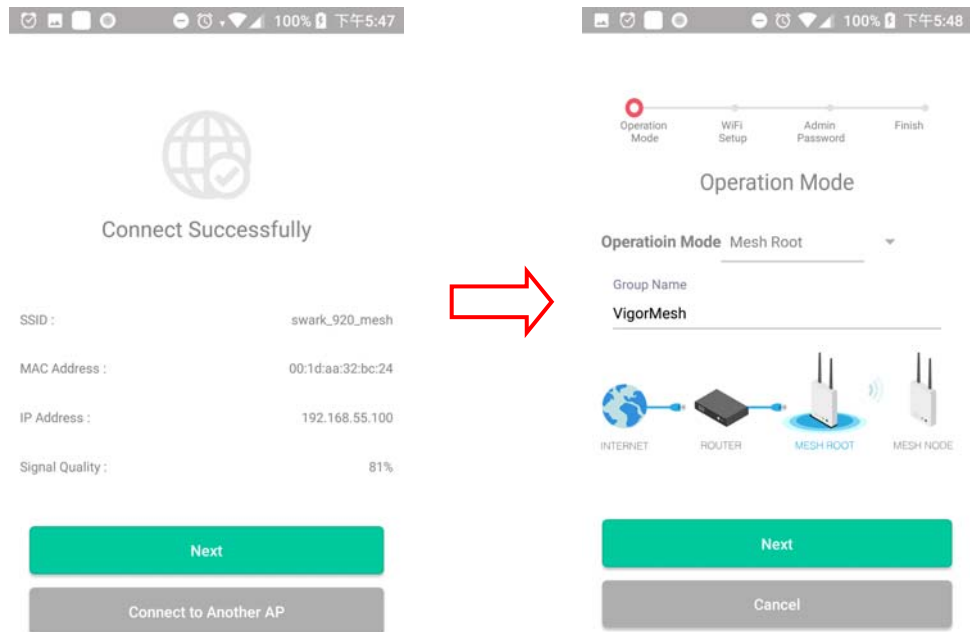

5. In the following page, set the WiFi Name (SSID) and WiFi Password for your network. You can also enable 2nd SSID by enabling the function of 2nd WiFi. Then, click **Next**.

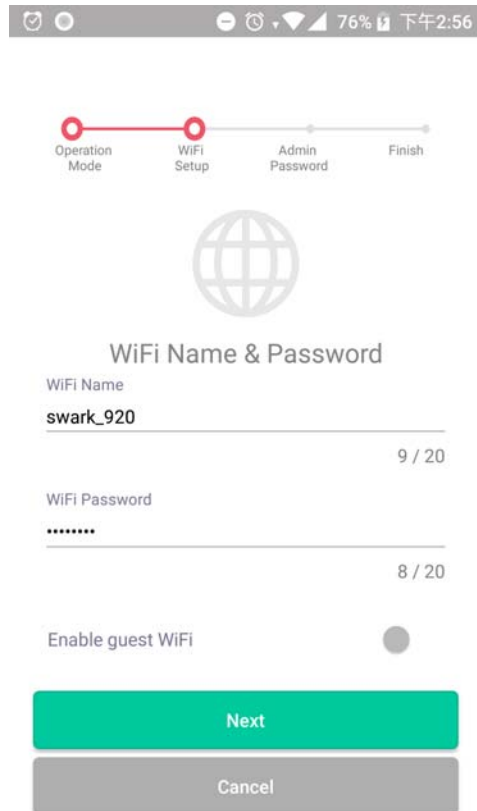

Operation Mode WiFi Setup Admin Password Finish

WiFi Name & Password

WiFi Name
swark_920
9 / 20

WiFi Password
.....
8 / 20

Enable guest WiFi

Next

Cancel

6. Change the default admin password for the network security and click **Next**.

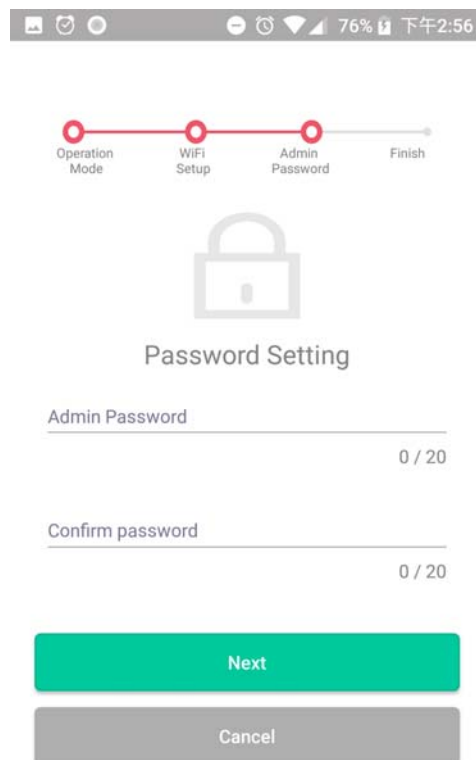

Operation Mode WiFi Setup Admin Password Finish

Password Setting

Admin Password
0 / 20

Confirm password
0 / 20

Next

Cancel

7. In the page of **Check and Apply**, click **Finish** to apply the settings to the specified VigorAP.



8. After sending configuration to VigorAP, it will take some time to take effect. DrayTek Wireless APP will try to reconnect to wireless network again. Please wait for a while here.

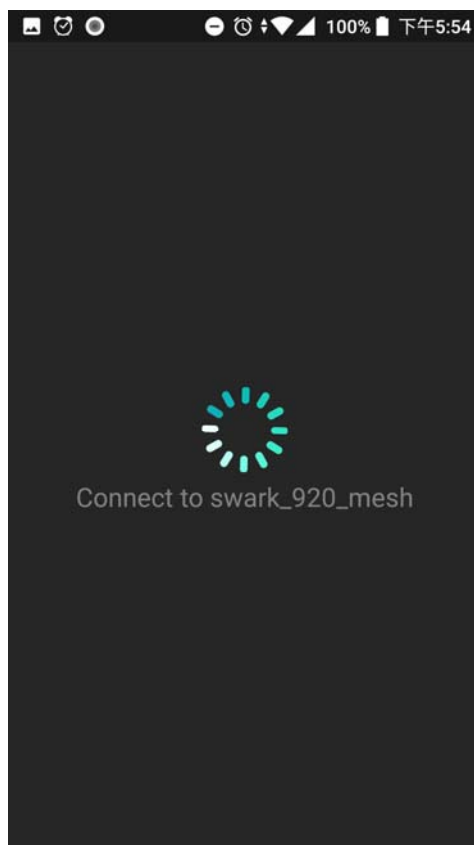

9. Now, the VigorAP has been set as Mesh Root. You can search several Mesh Nodes which do not belong to any other mesh group by clicking **Next**.

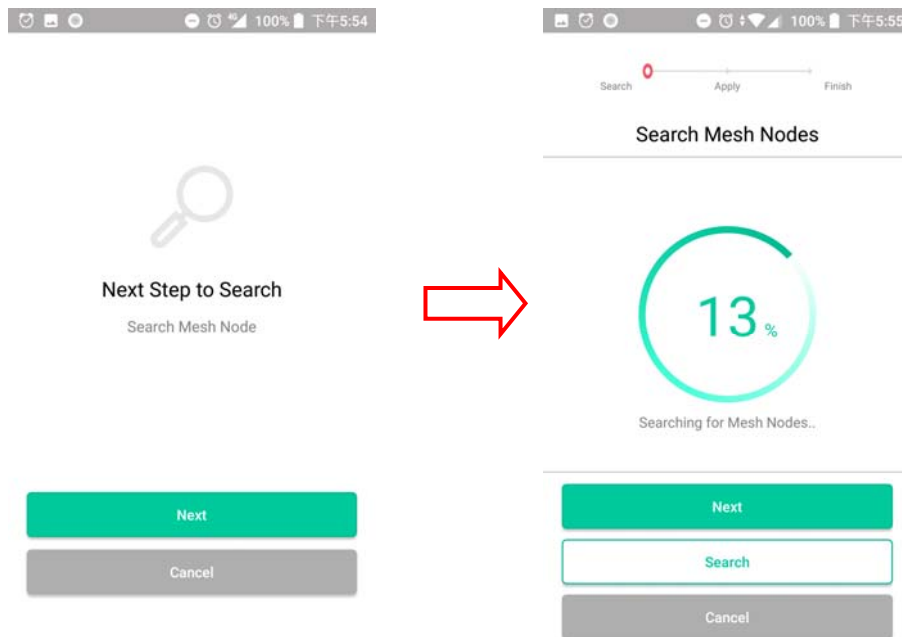

Or, click **Cancel** to return to the home page. Then, click **Add Nodes** to search several Mesh Nodes which do not belong to any other mesh group.

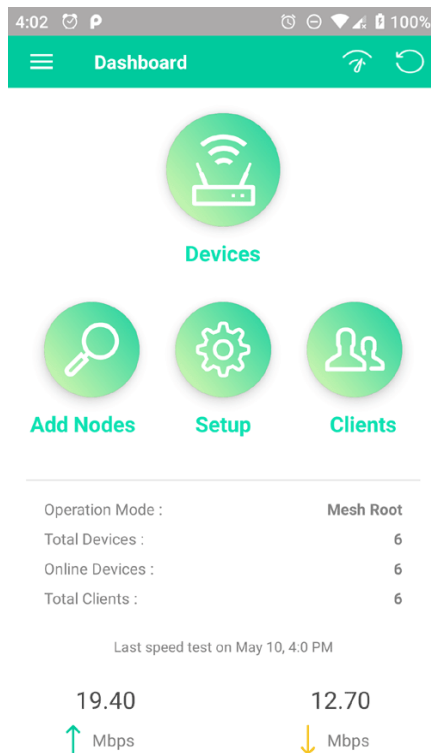

10. Later, available VigorAP devices will be shown on the page. Choose the Mesh Node you want to add and give a device name (e.g., VigorAP920R) for it. The selected mesh node(s) will be grouped under such mesh root. Click **Next**.

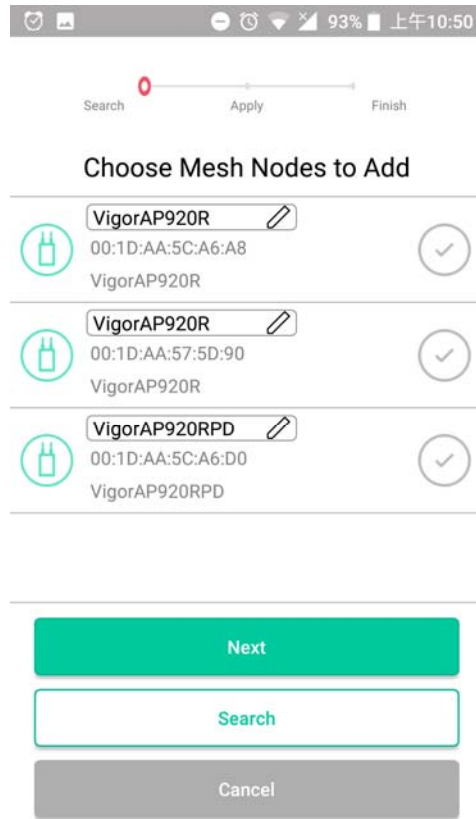

11. The following page displays the total number of mesh nodes selected. Click **Apply**.

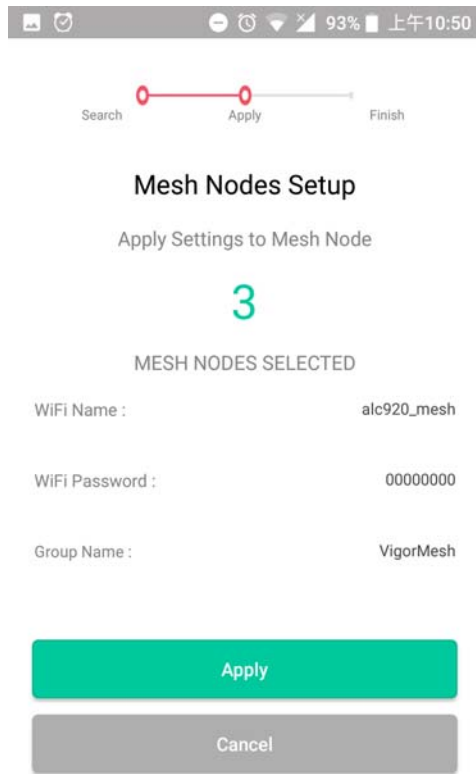

12. Wait until the mesh root applies general configuration to the mesh nodes.

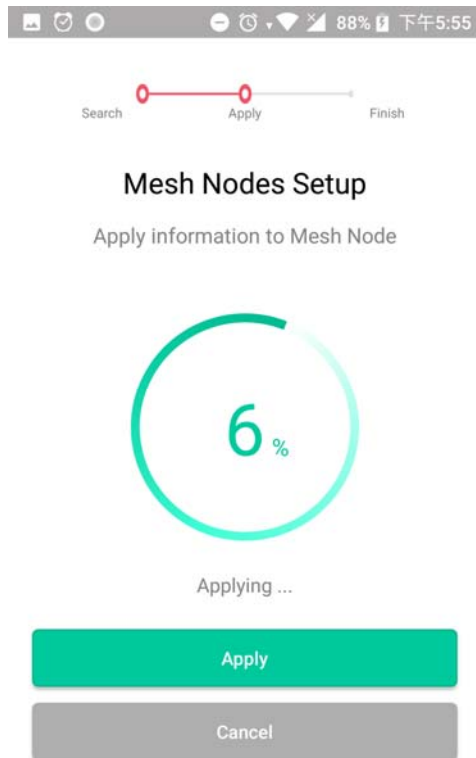

13. Later, current status of the mesh node(s) will be shown on the following page. Click **Finish**.



14. Now, the main page of VigorAP APP will be displayed as follows.

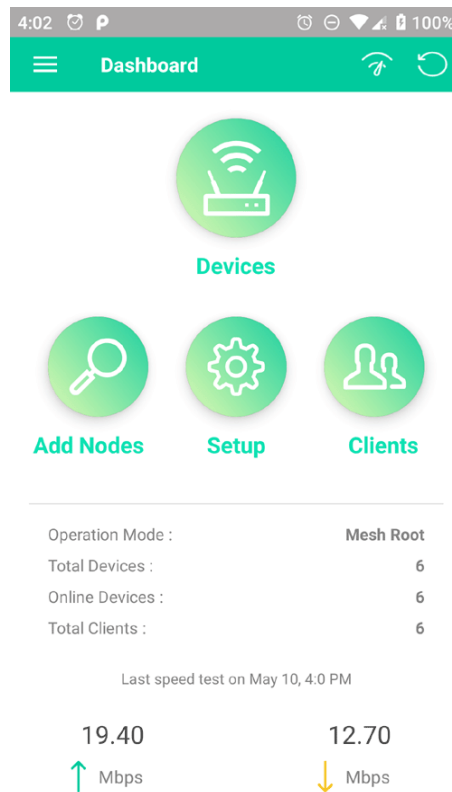

V-4 Login

The main page of VigorAP APP will be different slightly according to the operation mode of VigorAP.

After login to one AP with **Mesh Root**, the major information will be shown as follows:

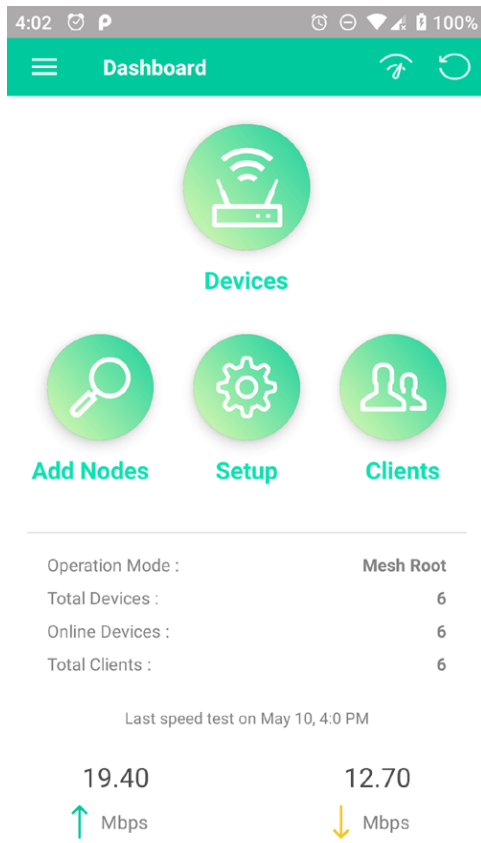

After login to one AP with **AP mode**, the major information will be shown as follows:

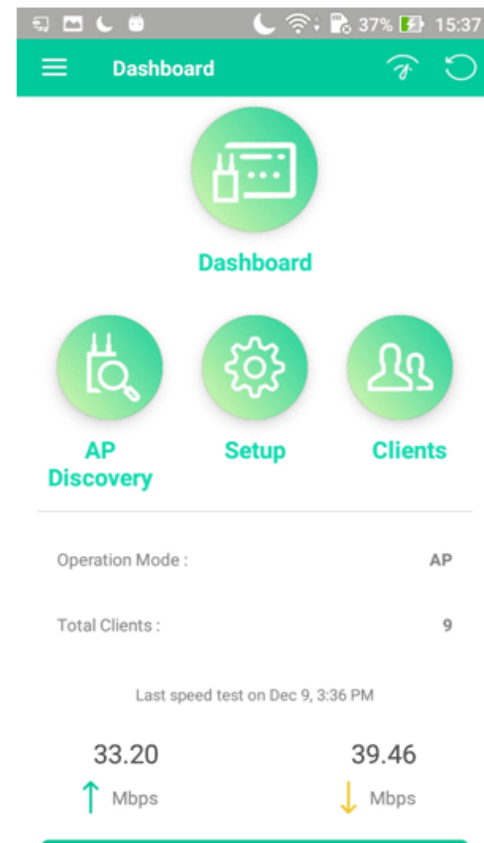

Available settings are explained as follows:

| Item | Description |
|----------------------------|----------------------------------------------------------------------------------------------------------------------------------------------------------------------------------------------------------------------------------------------------------------------------------------------------------------------------------------------------|
| Devices / Dashboard | <p>Dashboard - The dashboard is designed with Responsive Web Design. You can click Dashboard to connect to the selected VigorAP WUI.</p> <p>Devices - All of the devices (mesh root and mesh nodes) controlled by the mesh group will be shown on this page with hop number. One mesh group contains up to eight devices.</p> |



Add Nodes / AP Discovery

Add Nodes – Click it to add a new mesh node to this mesh group.
AP Discovery – Click it to search another access point.

Setup

Click it to configure TR069, Manage and WLAN settings for the connected VigorAP.



Setup Devices





TR069



Manage



WLAN

| | |
|----------------------------------------------------------------------------------------------------------------|----------------------------------------------------------------------------------------------------------------------------------------------------------------------------------------------------------------------|
| <p>Clients</p> | <p>Displays general information for all clients in Mesh Group or all clients connected to the selected AP (non-mesh device).</p>  |
| <p>Operation Mode</p> | <p>Display the operation mode (e.g., Mesh Root, AP, Mesh Node) of this AP.</p> |
| <p>Total Devices</p> | <p>Display the number of the total devices grouped under this mesh group.</p> |
| <p>Online Devices</p> | <p>Display current online devices grouped under this mesh group.</p> |
| <p>Total Clients</p> | <p>Display the number of the total clients connected to the mesh group or the selected AP (non-mesh device).</p> |
| <p> (Speed test)</p> | <p>Click it to make a speed test for the mesh group / AP.</p> |
| <p>Logout</p> | <p>Exit this APP.</p> |

This page is left blank.

Chapter VI Troubleshooting



VI-1 Diagnostics

This section will guide you to solve abnormal situations if you cannot access into the Internet after installing the router and finishing the web configuration. Please follow sections below to check your basic installation status stage by stage.

- Checking if the hardware status is OK or not.
- Checking if the network connection settings on your computer are OK or not.
- Pinging the router from your computer.
- Checking if the ISP settings are OK or not.
- Backing to factory default setting if necessary.

If all above stages are done and the router still cannot run normally, it is the time for you to contact your dealer or DrayTek technical support for advanced help.

Dagnostic tools provide a useful way to **view** or **diagnose** the status of your VigorAP 960C.

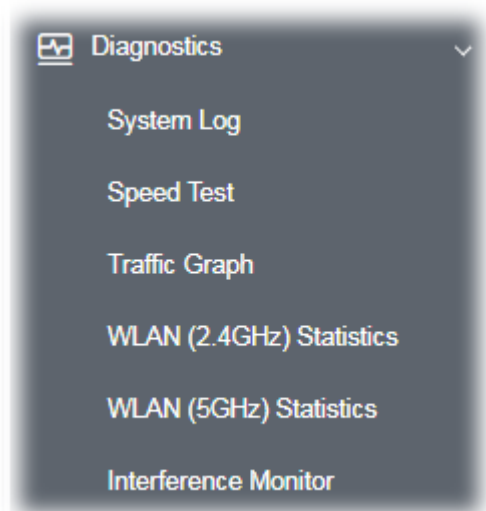

VI-1-1 System Log

At present, only **System Log** is offered.

Diagnostics >> System Log

System Log Information

| [Clear](#) | [Refresh](#) | Line wrap |

```
Jan 21 14:17:06 kernel: [96210.010000] STOPPED EVENT for vap 1 (pK-error)
Jan 21 14:17:06 kernel: [96210.010000] send_vdev_down_cmd_non_tlv for vap 1
Jan 21 14:17:06 kernel: [96210.040000] br0: port 5(ath1) entered disabled state
Jan 21 14:17:06 syslog: [DrayRS] Set Config : Disable RSSI Requirement
Jan 21 14:17:06 kernel: [96210.700000] Supported Rates in beacon : 6 9 12 18 24 36 48 54 M
Jan 21 14:17:06 kernel: [96210.700000] Beacon mode set to staggered. Cannot enable FD
Jan 21 14:17:06 kernel: [96210.710000] ol_ath_vap_set_param: Now supported MGMT RATE i
Jan 21 14:17:06 kernel: [96210.720000] ol_ath_vap_set_param: Now supported MGMT RATE i
Jan 21 14:17:06 kernel: [96210.730000] br0: port 4(ath0) entered forwarding state
Jan 21 14:17:06 kernel: [96210.730000] br0: port 4(ath0) entered forwarding state
Jan 21 14:17:06 kernel: [96210.740000] 8021q: adding VLAN 0 to HW filter on device ath0
Jan 21 14:17:06 kernel: [96210.790000] Supported Rates in beacon : 6 9 12 18 24 36 48 54 M
Jan 21 14:17:07 kernel: [96211.310000] Supported Rates in beacon : 6 9 12 18 24 36 48 54 M
Jan 21 14:17:07 kernel: [96211.310000] Beacon mode set to staggered. Cannot enable FD
Jan 21 14:17:07 kernel: [96211.320000] ol_ath_vap_set_param: Now supported MGMT RATE i
Jan 21 14:17:07 kernel: [96211.330000] ol_ath_vap_set_param: Now supported MGMT RATE i
Jan 21 14:17:07 kernel: [96211.340000] br0: port 5(ath1) entered forwarding state
```

VI-1-2 Speed Test

Click the **Start** button on the page to test the speed. Such feature can help you to find the best installation place for Vigor AP.

Diagnostics >> Speed Test

Speed Test

Welcome to VigorAP960C Speed Test.

This test allows you to find out the best place for VigorAP960C. You can execute the speed test at different places of the building and select the best location for it. The performance test result is only for your reference.

Start

VI-1-3 Traffic Graph

Click **Traffic Graph** to open the web page. Choose one of the managed Access Points, LAN-A, daily or weekly for viewing data transmission chart. Click **Refresh** to renew the graph at any time.

Diagnostics >> Traffic Graph

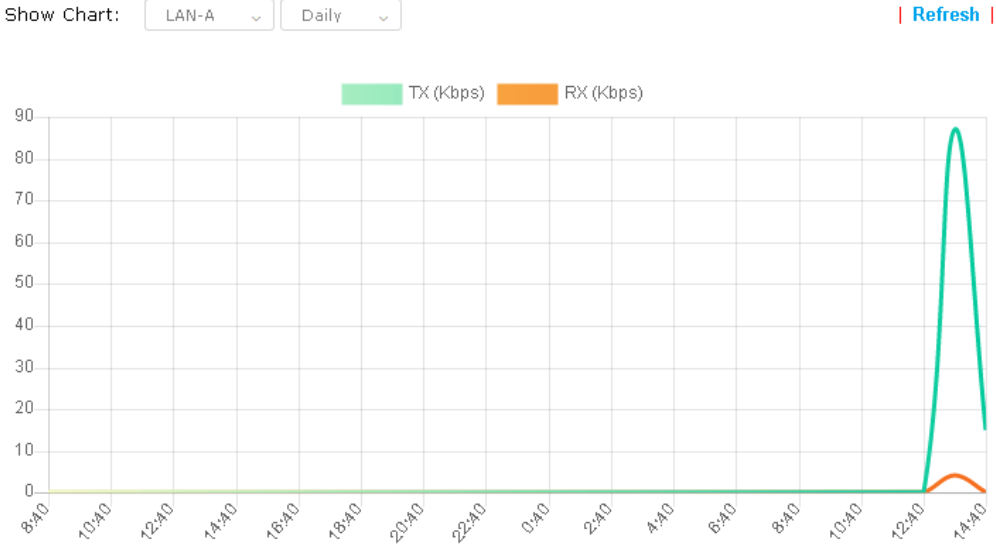

The horizontal axis represents time; the vertical axis represents the transmission rate (in kbps).

VI-1-4 WLAN (2.4GHz) Statistics

Such page is used for debug by RD only.

Diagnostics >> WLAN (2.4GHz) Statistics

Auto-Refresh

Refresh

| | | | |
|---------------------------------|------------|------------------------|------------|
| Tx Data Packets | 0 | Rx Data Packets | 0 |
| Tx Data Bytes | 0 | Rx Data Bytes | 0 |
| Average Tx Rate (kbps) | No Station | Average Rx Rate (kbps) | No Station |
| Tx Unicast Data Packets | 0 | Rx PHY errors | 942664 |
| Tx Multi/Broadcast Data Packets | 0 | Rx CRC errors | 0 |
| Tx failures | 0 | Rx MIC errors | 0 |
| | | Rx Decryption errors | 0 |
| | | Rx errors | 0 |

| | SSID1 (ap960c-BandSteering) | SSID2 (mk_carrie) | SSID3 (N/A) | SSID4 (N/A) |
|-------------------------------------|--------------------------------|----------------------|----------------|----------------|
| Tx Data Packets | 0 | 0 | N/A | N/A |
| Tx Data Bytes | 0 | 0 | N/A | N/A |
| Tx Data Bytes Tx Data Payload Bytes | 0 | 0 | N/A | N/A |
| Rx Data Packets | 0 | 0 | N/A | N/A |
| Rx Data Bytes | 0 | 0 | N/A | N/A |
| Rx Data Payload Bytes | 0 | 0 | N/A | N/A |
| Tx Unicast Data Packets | 0 | 0 | N/A | N/A |
| Tx Multi/Broadcast Data Packets | 0 | 0 | N/A | N/A |
| Average Tx Rate (kbps) | No Station | No Station | N/A | N/A |
| Average Rx Rate (kbps) | No Station | No Station | N/A | N/A |
| Rx errors | 0 | 0 | N/A | N/A |
| Tx failures | 0 | 0 | N/A | N/A |

VI-1-5 WLAN (5GHz) Statistics

Such page is used for debug by RD only.

Diagnostics >> WLAN (5GHz) Statistics

Auto-Refresh Refresh

| | | | |
|---------------------------------|------------|------------------------|------------|
| Tx Data Packets | 0 | Rx Data Packets | 0 |
| Tx Data Bytes | 0 | Rx Data Bytes | 0 |
| Average Tx Rate (kbps) | No Station | Average Rx Rate (kbps) | No Station |
| Tx Unicast Data Packets | 0 | Rx PHY errors | 753548 |
| Tx Multi/Broadcast Data Packets | 0 | Rx CRC errors | 0 |
| Tx failures | 0 | Rx MIC errors | 0 |
| | | Rx Decryption errors | 0 |
| | | Rx errors | 0 |

| | SSID1 (ap960c-BandSteering) | SSID2 (mk_carrie) | SSID3 (N/A) | SSID4 (N/A) |
|------------------------------------|--------------------------------|----------------------|----------------|----------------|
| Tx Data Packets | 0 | 0 | N/A | N/A |
| Tx Data Bytes | 0 | 0 | N/A | N/A |
| Tx Data BytesTx Data Payload Bytes | 0 | 0 | N/A | N/A |
| Rx Data Packets | 0 | 0 | N/A | N/A |
| Rx Data Bytes | 0 | 0 | N/A | N/A |
| Rx Data Payload Bytes | 0 | 0 | N/A | N/A |
| Tx Unicast Data Packets | 0 | 0 | N/A | N/A |
| Tx Multi/Broadcast Data Packets | 0 | 0 | N/A | N/A |
| Average Tx Rate (kbps) | No Station | No Station | N/A | N/A |
| Average Rx Rate (kbps) | No Station | No Station | N/A | N/A |
| Rx errors | 0 | 0 | N/A | N/A |
| Tx failures | 0 | 0 | N/A | N/A |

VI-1-6 Interference Monitor

As an interference detector, VigorAP can detect all of the environmental interference factors for certain channel used or for all of the wireless channels.

All Channels

This page displays the utilization and energy result for all channels based on 2.4G/5G. Click **Refresh** to get the newly update interference situation.

Diagnostics >> Interference Monitor

All Channels

Band: 2.4G (dropdown menu also shows 5G) Refresh

Recommended channel for usage: 2.4G

| Channel | Channel Load | Noise Floor | APs |
|---------|--------------|-------------|-----|
|---------|--------------|-------------|-----|

Last updated: 01/21 15:32:33

Note: During the scanning process, no station is allowed to connect with the AP.

VI-1-7 Support

When you click **Support**, you will be guided to visit www.draytek.com and open the corresponding pages directly.

Support (dropdown menu)

- Knowledge Base
- Product Registration

VI-2 Checking the Hardware Status

Follow the steps below to verify the hardware status.

1. Check the power line and cable connections.
Refer to “**I-2 Hardware Installation**” for details.
2. Power on the modem. Make sure the **POWER LED**, **ACT LED** and **LAN LED** are bright.
3. If not, it means that there is something wrong with the hardware status. Simply back to “**I-2 Hardware Installation**” to execute the hardware installation again. And then, try again.

VI-3 Checking the Network Connection Settings

Sometimes the link failure occurs due to the wrong network connection settings. After trying the above section, if the link is still failed, please do the steps listed below to make sure the network connection settings is OK.

VI-3-1 For Windows

Note:

The example is based on Windows 7 (Professional Edition). As to the examples for other operation systems, please refer to the similar steps or find support notes in www.draytek.com.

1. Open **All Programs>>Getting Started>>Control Panel**. Click **Network and Sharing Center**.

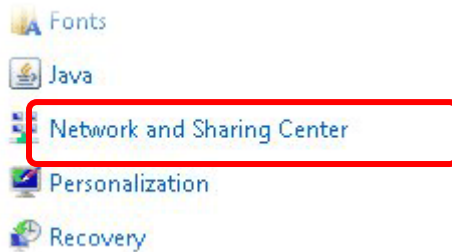

2. In the following window, click **Change adapter settings**.

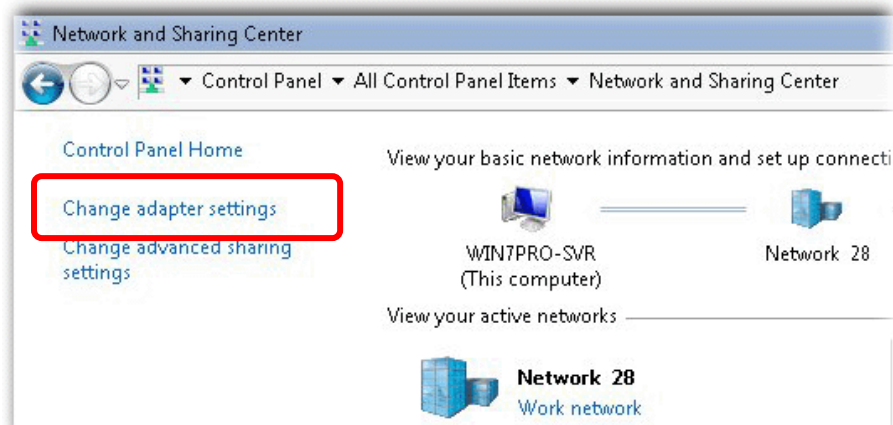

- Icons of network connection will be shown on the window. Right-click on **Local Area Connection** and click on **Properties**.

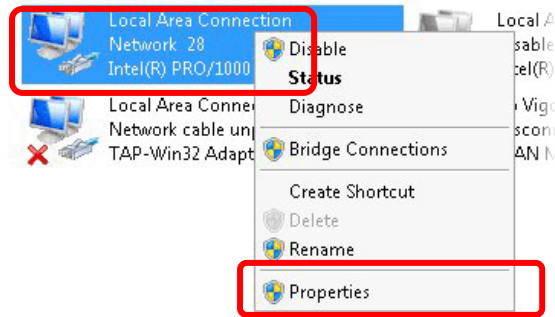

- Select **Internet Protocol Version 4 (TCP/IP)** and then click **Properties**.

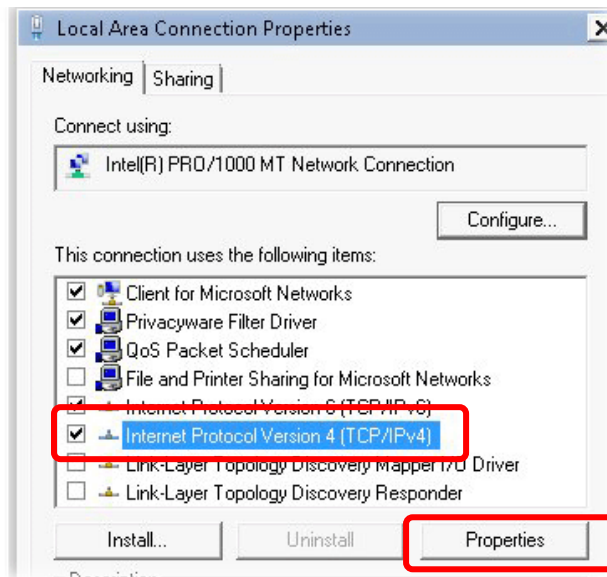

- Select **Obtain an IP address automatically** and **Obtain DNS server address automatically**. Finally, click **OK**.

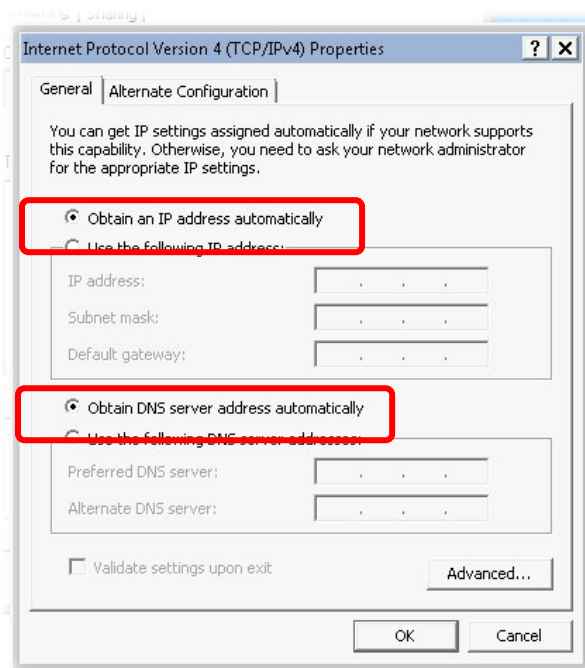

VI-3-2 For Mac Os

1. Double click on the current used Mac Os on the desktop.
2. Open the **Application** folder and get into **Network**.
3. On the **Network** screen, select **Using DHCP** from the drop down list of Configure IPv4.

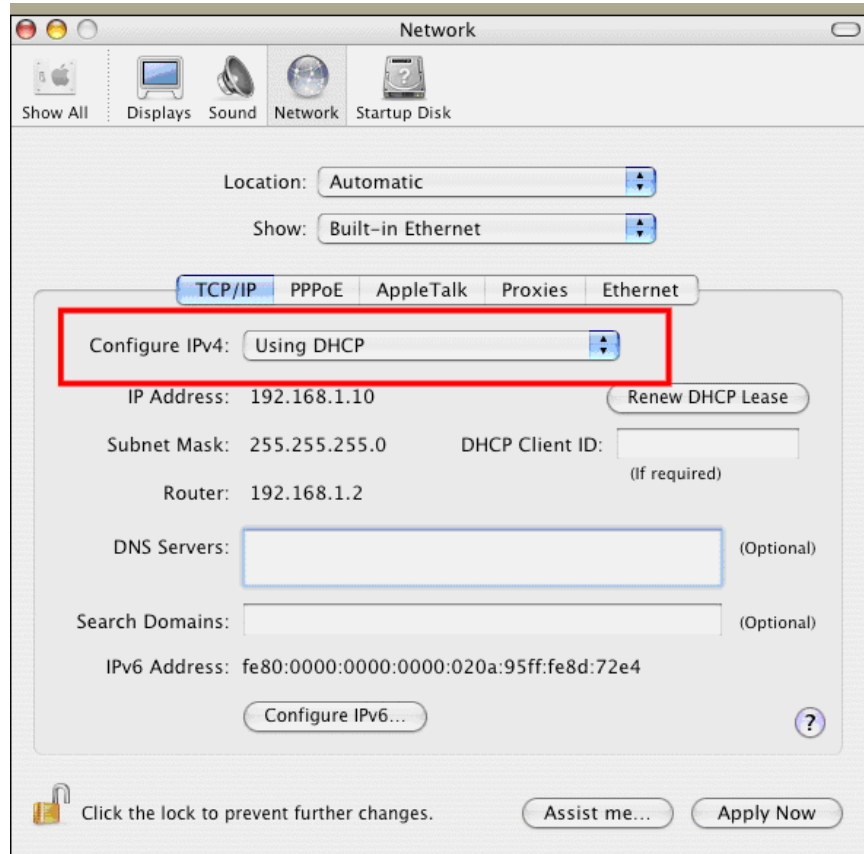

VI-4 Pinging the Device

The default gateway IP address of the modem is 192.168.1.2. For some reason, you might need to use “ping” command to check the link status of the modem. **The most important thing is that the computer will receive a reply from 192.168.1.2.** If not, please check the IP address of your computer. We suggest you setting the network connection as **get IP automatically**. (Please refer to the section V-2)

Please follow the steps below to ping the modem correctly.

VI-4-1 For Windows

1. Open the **Command Prompt** window (from **Start menu> Run**).
2. Type **command** (for Windows 95/98/ME) or **cmd** (for Windows NT/2000/XP/Vista/7). The DOS command dialog will appear.

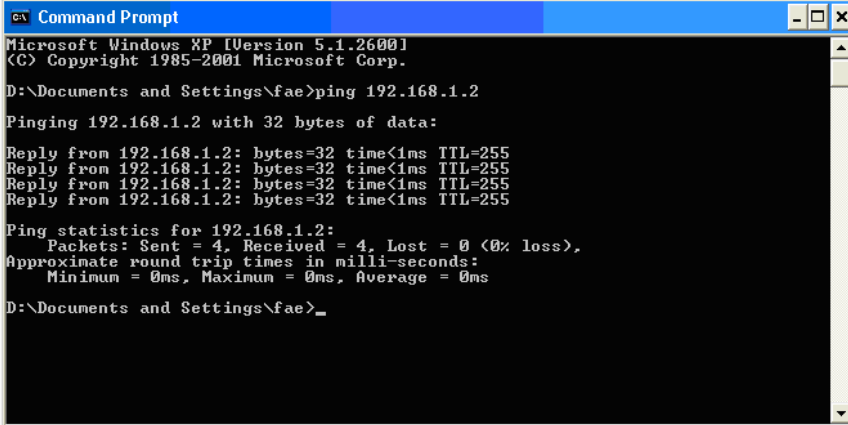

```
Microsoft Windows XP [Version 5.1.2600]
(C) Copyright 1985-2001 Microsoft Corp.

D:\Documents and Settings\fae>ping 192.168.1.2

Pinging 192.168.1.2 with 32 bytes of data:

Reply from 192.168.1.2: bytes=32 time<1ms TTL=255
Reply from 192.168.1.2: bytes=32 time<1ms TTL=255
Reply from 192.168.1.2: bytes=32 time<1ms TTL=255
Reply from 192.168.1.2: bytes=32 time<1ms TTL=255

Ping statistics for 192.168.1.2:
    Packets: Sent = 4, Received = 4, Lost = 0 (0% loss),
    Approximate round trip times in milli-seconds:
        Minimum = 0ms, Maximum = 0ms, Average = 0ms

D:\Documents and Settings\fae>
```

3. Type ping 192.168.1.2 and press [Enter]. If the link is OK, the line of “**Reply from 192.168.1.2:bytes=32 time<1ms TTL=255**” will appear.
4. If the line does not appear, please check the IP address setting of your computer.

VI-4-2 For Mac Os (Terminal)

1. Double click on the current used Mac Os on the desktop.
2. Open the **Application** folder and get into **Utilities**.
3. Double click **Terminal**. The Terminal window will appear.
4. Type **ping 192.168.1.2** and press [Enter]. If the link is OK, the line of “**64 bytes from 192.168.1.2: icmp_seq=0 ttl=255 time=xxxx ms**” will appear.

```
Terminal — bash — 80x24
Last login: Sat Jan  3 02:24:18 on ttys1
Welcome to Darwin!
Vigor10:~ draytek$ ping 192.168.1.1
PING 192.168.1.1 (192.168.1.1): 56 data bytes
64 bytes from 192.168.1.1: icmp_seq=0 ttl=255 time=0.755 ms
64 bytes from 192.168.1.1: icmp_seq=1 ttl=255 time=0.697 ms
64 bytes from 192.168.1.1: icmp_seq=2 ttl=255 time=0.716 ms
64 bytes from 192.168.1.1: icmp_seq=3 ttl=255 time=0.731 ms
64 bytes from 192.168.1.1: icmp_seq=4 ttl=255 time=0.72 ms
^C
--- 192.168.1.1 ping statistics ---
5 packets transmitted, 5 packets received, 0% packet loss
round-trip min/avg/max = 0.697/0.723/0.755 ms
Vigor10:~ draytek$
```

VI-5 Backing to Factory Default Setting

Sometimes, a wrong connection can be improved by returning to the default settings. Try to reset the modem by software or hardware.

Warning:

After pressing **factory default setting**, you will lose all settings you did before. Make sure you have recorded all useful settings before you pressing. The password of factory default is null.

VI-5-1 Software Reset

You can reset the modem to factory default via Web page.

Go to **System Maintenance** and choose **Reboot System** on the web page. The following screen will appear. Choose **Using factory default configuration** and click **OK**. After few seconds, the modem will return all the settings to the factory settings.

System Maintenance >> Reboot System

Reboot System

Do You want to reboot your AP ?

Using current configuration

Using factory default configuration

OK

VI-5-2 Hardware Reset

While the modem is running, press the **Factory Reset** button and hold for more than 5 seconds. When you see the **ACT** LED blinks rapidly, please release the button. Then, the modem will restart with the default configuration.



After restore the factory default setting, you can configure the settings for the modem again to fit your personal request.

VI-6 Contacting DrayTek

If the modem still cannot work correctly after trying many efforts, please contact your dealer for further help right away. For any questions, please feel free to send e-mail to support@draytek.com.

Index

8

802.11n, 45

A

Access Control, 49

Action, 135

Advanced Setting, 52

AES, 34

Airtime Fairness, 55

AP Discovery, 54

AP Management, 113

AP Mode, 43, 72, 86

AP Operation Mode, 23

APM Log, 114

Applications, 134, 137

Auth Mode, 51

Authentication Client, 131

Authentication Type, 131

Auto Channel Filtered Out List, 53

Auto Logout, 19

Auto Provision, 113

AutoSelect, 87

B

Band Steering, 61

Bandwidth Limit, 24, 27, 33

Black List, 115

C

Central AP Management, 113

Certificate Management, 131

Changing Password, 20

Channel, 45, 87

Channel Width, 52

Client IP, 131

Client PinCode, 51

Client's MAC Address, 115

Configuration Backup, 103, 104

Connect to a Vigor Router, 10

Connection Time, 58

Connection Type, 88

Country Code, 53

D

Daylight Saving, 107

Default Gateway, 88

Detection, 117, 124, 125

DHCP Client, 91

DHCP server, 17

E

EAP Type, 131

Encryp Type, 51

End Time, 135

Extension Channel, 45

F

Factory Default Setting, 170

Factory Reset, 3

Fast Roaming, 60

Firmware Upgrade, 112

Force Overload Disassociation, 115

Fragment Length, 52

G

General Setup, LAN, 90

H

Hardware Installation, 4

Hardware Reset, 171

Hide SSID, 45

HTTP port, 109

HTTPS, 133

HTTPS port, 109

I

Interference Monitor, 163

IP Address, 88, 91

Isolate Member, 45

K

Keep Alive Period, 101
Key Renewal Interval, 47
Key Size, 133
Key Type, 133

L

LAN, 90
Lease Time, 91
LED Indicators and Connectors, 3
Limit Client, 44
Limit Client per SSID, 45
Load Balance, 115

M

MAC Address, 87
MAC Address Filter, 50
MAC Clone, 53
Main SSID, 24, 26, 33
Management, 109
Management VLAN, 91
Mobile Device Management, 117
Mode, 45, 46

N

NTP, 134
NTP Client, 107
NTP Server, 107
NTP synchronization, 107

O

Once, 136
Open/Shared, 34, 88
Operation Mode, 38
Overload Management, 115

P

Pass Phrase, 47, 88
Password, 20
Password Strength, 102
Periodic Inform Settings, 101
PIN Code, 41
PMK Cache Period, 60

Policy, 49, 126, 127
Port, 48
Port Control, 93, 96
Pre-Authentication, 60
Primary DNS Server, 91
PSK, 40
Push Button, 51

Q

Quick Start Wizard, 22

R

RADIUS Server, 48, 130
RADIUS Setting, 130
Reboot System, 111
Reconnection Time, 58
Relay Agent, 91
Restore, 50
Roaming, 59
Router Name, 88
Routine, 136
RSSI, 59
RTS Threshold, 52

S

Schedule, 134, 137, 139
Secondary DNS Server, 91
Secret Key, 131
Security, 46
Security Mode, 87
Security Overview, 40
Security Settings, 46
Session Timeout, 48
Shared Secret, 48
Show Chart, 124
Software Reset, 170
Speed Test, 159
SSL(HTTPS), 101
Start Date, 135
Start PBC, 41
Start Time, 135
Station Control, 24, 27, 33, 58
Station List, 66

Status of Settings, 116
STUN, 101
Subject Name, 132
Subnet, 45
Subnet Mask, 88, 91
Support Area, 163
Syslog/Mail Alert, 106
System Log, 159
System Maintenance, 98
System Status, 99

T

Temperature Sensor, 136
Time and Date, 107
Time Zone, 107
TKIP, 34, 40
TR-069, 100
Traffic Graph, 160
traffic overload, 115
Tx Power, 52

U

Users Profile, 131

V

VLAN ID, 45, 91

W

WEP, 34
WEP (Wired Equivalent Privacy), 40
White List, 115
Wi-Fi DOWN, 135
Wi-Fi UP, 135
Wired Connection, 4, 5, 6, 8, 9, 10
WLAN (2.4GHz) Statistics, 161
WLAN (5GHz) Statistics, 162
WPA (Wi-Fi Protected Access), 40
WPA Algorithms, 47
WPS, 50
WPS (Wi-Fi Protected Setup), 41