

This Quick Guide is a reference for users to install and operate the Dome Camera quickly, and thus only provides basic information on the Dome Camera's various setting and operation. Before attempting to connect, configure and operate the Dome Camera, please read its Installation Guide and User Manual thoroughly.

System Configuration

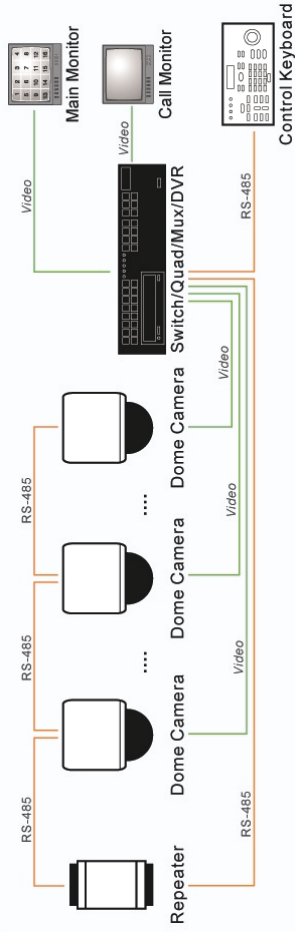

Standard Equipments

- Dome Camera
- Optical Cover
- Data Cable (Indoor Dome Camera: DC12V/AC 24V; Outdoor Dome Cameras: AC 24V)
- Accessories (Indoor Dome Camera: Hard Ceiling Mount with Decoration Ring, Fixing Plate and M3 Screw×1; Outdoor Dome Camera: Waterproof Rubber, Security Torx, M3/M5 Standard/Security Screws and Lubricant)
- Quick Guide (Contains general Dome Camera setups information)
- CD (Contains operation manuals)

Switch Definition

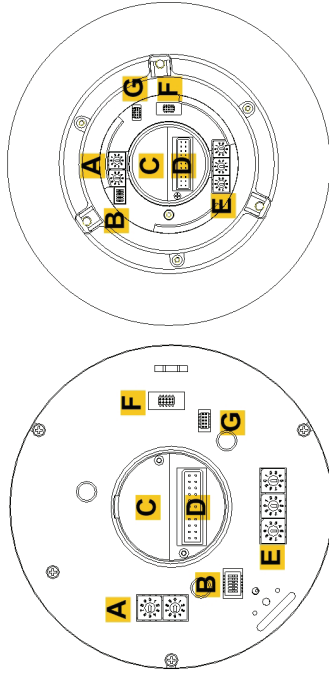

Indoor	Outdoor
A Camera Control Protocol Switch	
B Communication Switch	
C None	
D 22-Pin Connector	
E ID Switch	
F Reserved	
G ISP Connector (for FW upgrade)	

Communication Switch Setting

The table below shows the function of each switch within the Communication Switch on the Dome Camera's back plate.

Communication Switch	SW 1	RS-485 Setting
	SW 2	Termination
	SW 3	Line Lock
	SW 4	Factory Default Reset
	SW 5	Reserved
	SW 6	

RS-485 Setting	Full-duplex	Half-duplex

ID Setting

Please change the Dome Camera's ID if there is more than one Dome Camera in the same network. To change your Dome Camera's ID, please turn the arrow of the ID switch to a desired number respectively. For instance, if the Dome Camera's ID is 123, the ID switch should be set as shown below. The default ID is "001."

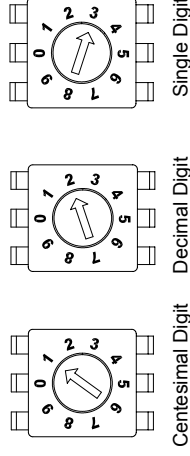

Camera Control Protocol Setting

Refer to the table below and select one sets of protocol and baud rate you would like to use, basing on the control device; then adjust the protocol switch on the Dome Camera's back plate. For instance, the protocol switch should be set as below if you select protocol Pelco D, with switch no. 01 and baud rate 2400.

Switch No.	Protocol	Baud Rate
00	VCL	9600
01	Pelco D	2400
02	Pelco P	4800
04	Chiper	9600
05	Phillips	9600
07	DSCP	9600
08	AD422	4800
09	DM P	9600
11	Pelco D	4800
12	Pelco D	9600
13	Pelco P	2400
14	Pelco P	9600
15	JVC	9600
21	Kalatel-485	9600
22	Kalatel-422	4800

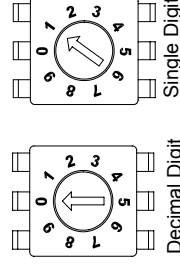

Data Cable and Connector Definition

Please refer to the illustrations below for connector definition of each kind of Data Cable before wiring.

Indoor Dome Camera:

DC 12V Data Cable

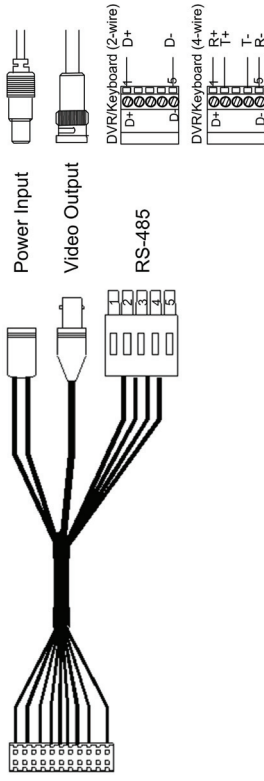

AC 24V Data Cable

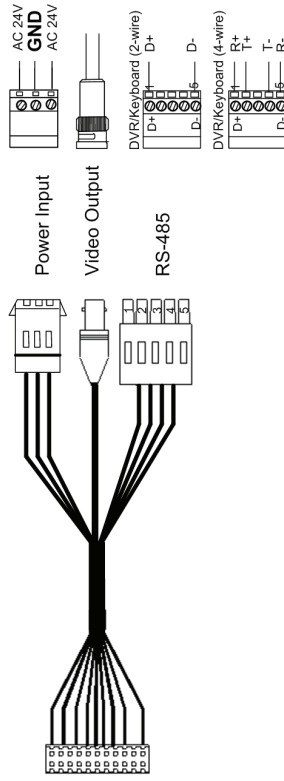

Outdoor Dome Camera:

AC 24V Data Cable

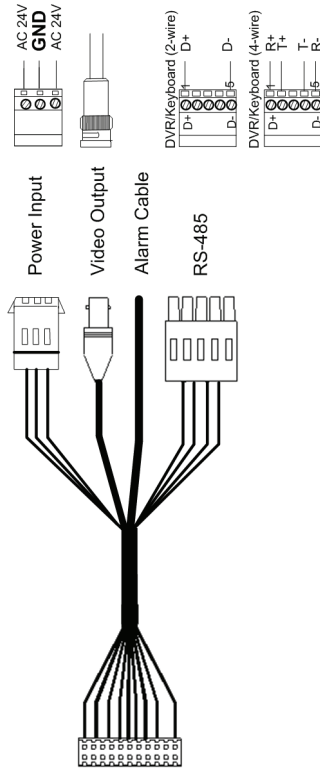

NOTE:

1. Input electricity to the unit is at tolerance of DC 12V/AC 24V \pm 10%.
2. When wiring the AC 24V power cable, make sure the **Ground** wire is inserted into the mid-pin of the terminal block.

22-Pin Connector Definition

When cabling, please refer to the table below for pin definition of the Data Cable's 22-pin connector on the Data Cable.



Pin	Definition	Cable
1	AC 24-1/DC (+)	20AWG/18AWG
2	ALM NC	
3	AC 24-2/DC (-)	20AWG/18AWG
4	ALM NO	
5	FG	20AWG/18AWG
6	ALM COM	
7	T+	24AWG
8	R-	
9	T-	
10	R+	
11	ISOG	
12	ALM-1	
13	ALM-3	
14	ALM-2	
15	ALM-4	
16	ALM-5	
17	ALM-6	
18	ALM-7	
19	ALM-8	
20	ALM GND	
21	VGND	20AWG
22	Video	