



Legal notice

Copyright © 2015 TELTONIKA Ltd. All rights reserved. Reproduction, transfer, distribution or storage of part or all of the contents in this document in any form without the prior written permission of TELTONIKA Ltd is prohibited. The manufacturer reserves the right to modify the product and manual for the purpose of technical improvement without prior notice.

Other product and company names mentioned herein may be trademarks or trade names of their respective owners.

Attention



Before using the device we strongly recommend reading this user manual first.



Do not rip open the device. Do not touch the device if the device block is broken.



All wireless devices for data transferring may be susceptible to interference, which could affect performance.



The device is not water-resistant. Keep it dry.



Device is powered by low voltage +9V DC power adaptor.



Please do not scratch the device. Scratched device is not fully protected.

Table of Contents

Legal notice.....	2
Attention.....	2
SAFETY INFORMATION	9
Device connection	10
1 Introduction	11
2 Specifications	11
2.1 Ethernet	11
2.2 Wi-Fi.....	11
2.3 Hardware	11
2.4 Electrical, Mechanical & Environmental.....	12
2.5 Applications	12
3 Setting up your router	13
3.1 Installation	13
3.1.1 Front Panel and Back Panel	13
3.1.2 Connection status LED indication	13
3.1.3 Hardware installation	14
3.2 Logging in.....	15
4 Operation Modes.....	18
5 Powering Options	19
5.1 Powering the device from higher voltage.....	19
6 Status	20
6.1 Overview	20
6.2 System Information	20
6.3 Network Information	22
6.4 Device information	30
6.5 Services	32
1.1 Routes	32
6.5.1 ARP.....	32
6.5.2 Active IP-Routes	33

6.5.3	Active IPv6-Routes	33
6.6	Graphs.....	33
6.6.1	Mobile Signal Strength.....	33
6.6.2	Realtime Load	34
6.6.3	Realtime Traffic.....	35
6.6.4	Realtime Wireless	36
6.6.5	Realtime Connections	37
6.7	Mobile Traffic.....	38
6.8	Speed Test.....	38
6.9	Events Log	39
6.9.1	All Events.....	39
6.9.2	System Events	40
6.9.3	Network Events.....	41
6.9.4	Events Reporting.....	42
6.9.5	Reporting Configuration	43
7	Network	46
7.1	Mobile.....	46
7.1.1	General.....	46
7.1.2	SIM Management	49
7.1.3	Network Operators	50
7.1.4	Mobile Data Limit.....	51
7.1.5	SIM Idle protection	52
7.2	WAN.....	53
7.2.1	Operation Mode	53
7.2.2	Common configuration	54
7.3	LAN.....	60
7.3.1	Configuration	60
7.3.2	DHCP Server	61
7.4	Wireless	63
7.5	VLAN.....	66
7.5.1	VLAN Networks	66
7.5.2	LAN Networks	68
7.6	Firewall.....	68
7.6.1	General Settings.....	68
7.6.2	DMZ.....	69

7.6.3	Port Forwarding	69
7.6.4	Traffic Rules.....	72
7.6.5	Custom Rules	76
7.6.6	DDOS Prevention	76
7.6.7	Port Scan Prevention	79
7.7	Routing.....	79
7.7.1	Static Routes	79
7.7.2	Dynamic Routes	80
7.8	Load Balancing	84
8	Remote monitoring and administration	84
9	Services	86
9.1	VRRP.....	86
9.1.1	VRRP LAN Configuration Settings	86
9.1.2	Check Internet connection.....	87
9.2	TR-069	87
9.2.1	TR-069 Parameters Configuration	87
9.3	Web filter	88
9.3.1	Site blocking.....	88
9.3.2	Proxy Based Content Blocker	88
9.4	NTP.....	89
9.5	RS232/RS485.....	91
9.5.1	RS232	91
9.5.2	RS485	93
9.5.3	Modes of different serial types in RS232 and RS485.....	96
9.6	VPN	100
9.6.1	OpenVPN.....	100
9.6.2	IPSec.....	103
9.6.3	GRE Tunnel.....	106
9.6.4	PPTP	108
9.6.5	L2TP.....	109
9.7	Dynamic DNS.....	109
9.8	SMS Utilities.....	111
9.8.1	SMS Utilities	111
9.8.2	Call Utilities	118
9.8.3	User Groups	119

9.8.4	SMS Management.....	119
9.8.5	Remote Configuration.....	121
9.8.6	Statistics	124
9.9	SNMP	124
9.9.1	SNMP Settings.....	125
9.9.2	TRAP Settings	126
9.10	SMS Gateway	126
9.10.1	Post/Get Configuration	126
9.10.2	Email to SMS.....	128
9.10.3	Scheduled Messages	129
9.10.4	Auto Reply Configuration	129
9.10.5	SMS Forwarding.....	130
9.10.6	SMPP.....	133
9.11	GPS.....	133
9.11.1	GPS.....	133
9.11.2	GPS Settings.....	134
9.11.3	GPS Mode	134
9.11.4	GPS I/O	135
9.11.5	GPS Geofencing	136
9.12	Hotspot	137
9.12.1	General settings.....	137
9.12.2	Internet Access Restriction Settings.....	139
9.12.3	Logging.....	140
9.12.4	Landing Page.....	141
9.12.5	Radius server configuration.....	143
9.12.6	Statistics.....	144
9.13	CLI.....	144
9.14	Auto Reboot.....	145
9.14.1	Ping Reboot	145
9.14.2	Periodic Reboot	146
9.15	UPNP	146
9.15.1	General Settings	146
9.15.2	Advanced Settings	146
9.15.3	UPnP ACLs.....	147
9.15.4	Active UPnP Redirects	147

9.16	QoS.....	147
9.17	Network Shares.....	148
9.17.1	Mounted File Systems	148
9.17.2	Samba.....	149
9.17.3	Samba User.....	149
9.18	Input/Output.....	151
9.18.1	Status.....	151
9.18.2	Input	151
9.18.3	Output	154
9.18.4	Input/Output hardware information.....	157
9.19	MQTT	163
9.20	Modbus TCP interface.....	168
10	System.....	169
10.1	Configuration Wizard.....	169
10.2	Profiles	171
10.3	Administration	172
10.3.1	General	172
10.3.2	Troubleshoot	173
10.3.3	Backup	174
10.3.4	Diagnostics.....	176
10.3.5	MAC Clone	177
10.3.6	Overview.....	177
10.3.7	Monitoring.....	178
10.4	User scripts	178
10.5	Restore point	179
10.5.1	Restore point create.....	179
10.5.2	Restore point load	179
10.6	Firmware.....	180
10.6.1	Firmware.....	180
10.6.2	FOTA	181
10.7	Reboot.....	181
11	Device Recovery.....	181
11.1	Reset button	182
11.2	Bootloader's WebUI.....	182
12	Glossary:.....	182

13 Changelog185

SAFETY INFORMATION

In this document you will be introduced on how to use a router safely. We suggest you to adhere to the following recommendations in order to avoid personal injuries and or property damage.

You have to be familiar with the safety requirements before using the device!

To avoid burning and voltage caused traumas, of the personnel working with the device, please follow these safety requirements.



The device is intended for supply from a Limited Power Source (LPS) that power consumption should not exceed 15VA and current rating of overcurrent protective device should not exceed 2A.



The highest transient overvoltage in the output (secondary circuit) of used PSU shall not exceed 36V peak.



The device can be used with the Personal Computer (first safety class) or Notebook (second safety class). Associated equipment: PSU (power supply unit) (LPS) and personal computer (PC) shall comply with the requirements of standard EN 60950-1.



Do not mount or service the device during a thunderstorm.



To avoid mechanical damages to the device it is recommended to transport it packed in a damage-proof pack.



Protection in primary circuits of associated PC and PSU (LPS) against short circuits and earth faults of associated PC shall be provided as part of the building installation.

To avoid mechanical damages to the device it is recommended to transport it packed in a damage-proof pack. While using the device, it should be placed so, that its indicating LEDs would be visible as they inform in which working mode the device is and if it has any working problems.

Protection against overcurrent, short circuiting and earth faults should be provided as a part of the building installation.

Signal level of the device depends on the environment in which it is working. In case the device starts working insufficiently, please refer to qualified personnel in order to repair this product. We recommend forwarding it to a repair center or the manufacturer. There are no exchangeable parts inside the device.

Device connection

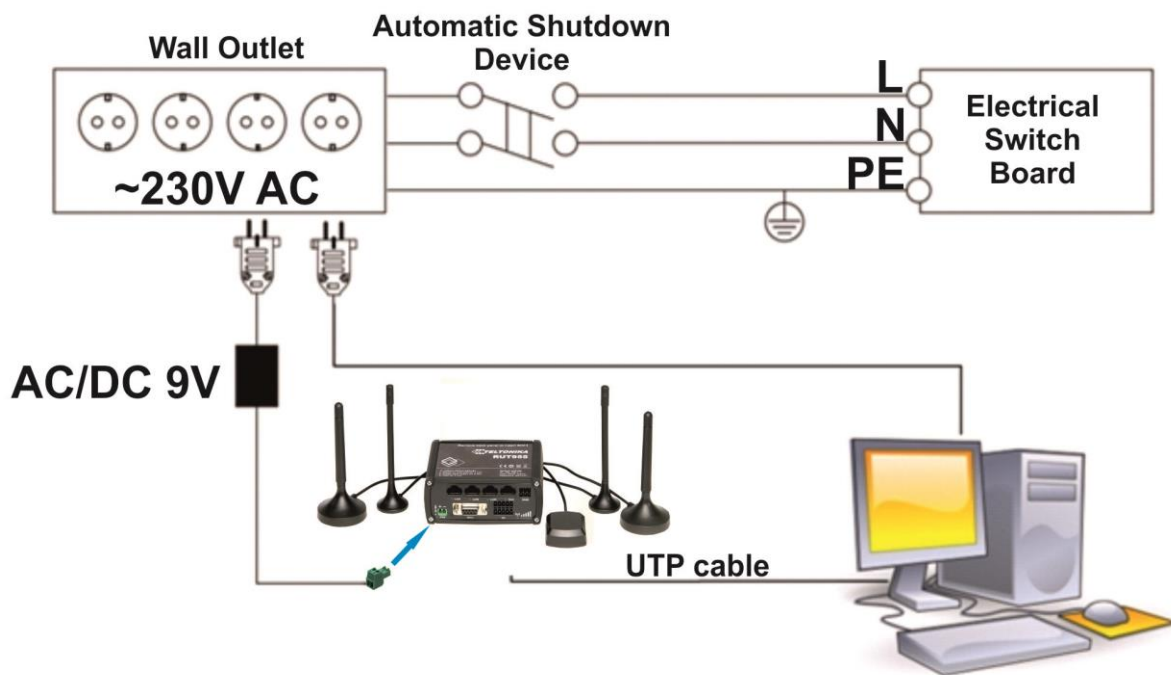

1 Introduction

Thank you for purchasing a RUT955 LTE router!

RUT955 is part of the RUT9xx series of compact mobile routers with high speed wireless and Ethernet connections.

This router is ideal for people who'd like to share their internet on the go, as it is not restricted by a cumbersome cable connection. Unrestricted, but not forgotten: the router still supports internet distribution via a broadband cable, simply plug it in to the wan port, set the router to a correct mode and you are ready to browse.

2 Specifications

2.1 Ethernet

- IEEE 802.3, IEEE 802.3u standards
- 3 x LAN 10/100Mbps Ethernet ports
- 1 x WAN 10/100Mbps Ethernet port
- Supports Auto MDI/MDIX

2.2 Wi-Fi

- IEEE 802.11b/g/n WiFi standards
- 2x2 MIMO
- AP and STA modes
- 64/128-bit WEP, WPA, WPA2, WPA&WPA2 encryption methods
- 2.401 – 2.495GHz Wi-Fi frequency range
- 20dBm max WiFi TX power
- SSID stealth mode and access control based on MAC address

2.3 Hardware

- High performance 560 MHz CPU with 128 Mbytes of DDR2 memory
- 2 pin industrial DC power socket
- Attachable DIN rail adapter
- 4 pin industrial socket for 2/4 wire RS485
- DB9 socket for full-featured RS232
- USB A socket for external devices 4 pin industrial socket for 2/4 wire RS485
- Reset/restore to default button
- 2 x SMA for LTE , 2 x RP-SMA for WiFi antenna connectors
- 4 x Ethernet LEDs, 1 x Power LED
- 1 x bi-color connection status LED, 5 x connection strength LEDs
- 10 pin industrial socket for inputs/outputs:
 - 0 - 3 V digital input
 - 0 - 30 V digital galvanically isolated input
 - 0 - 24 V analog input 30 V, 250 mA digital open collector output
 - 40 V, 4 A SPST relay output

2.4 Electrical, Mechanical & Environmental

- Dimensions (H x W x D) 80mm x 106mm x 46mm
- Weight 250g
- Power supply 100 – 240 VAC -> 9 VDC wall adapter
- Input voltage range 9 – 30VDC
- Power consumption < 7W
- Operating temperature -40° to 75° C
- Storage temperature -45° to 80° C
- Operating humidity 10% to 90% Non-condensing
- Storage humidity 5% to 95% Non-condensing

2.5 Applications

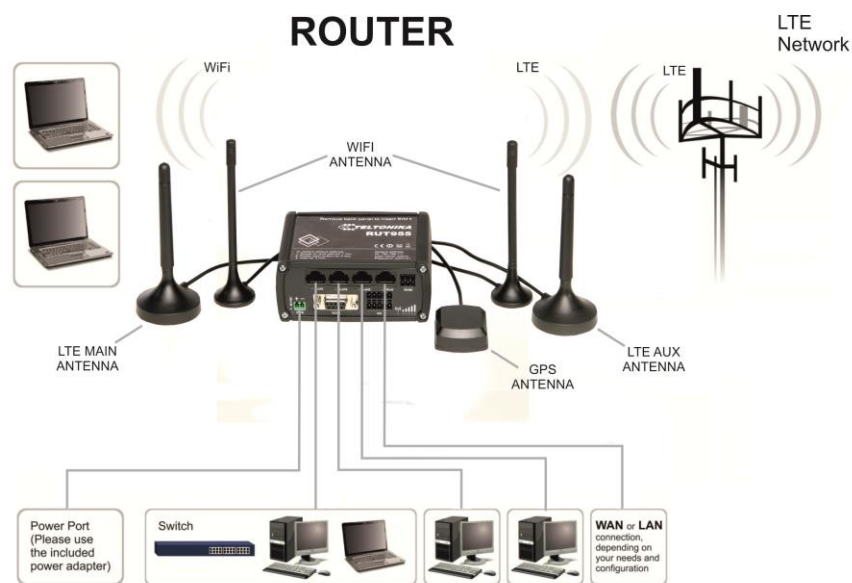

3 Setting up your router

3.1 Installation

After you unpack the box, follow the steps, documented below, in order to properly connect the device. For better Wi-Fi performance, put the device in clearly visible spot, as obstacles such as walls and door hinder the signal.

1. First assemble your router by attaching the necessary antennas and inserting the SIM card.
2. To power up your router, please use the power adapter included in the box. (IMPORTANT: Using a different power adapter can damage and void the warranty for this product.)
3. If you have a wired broadband connection you will also have to connect it to the WAN port of the router.

3.1.1 Front Panel and Back Panel

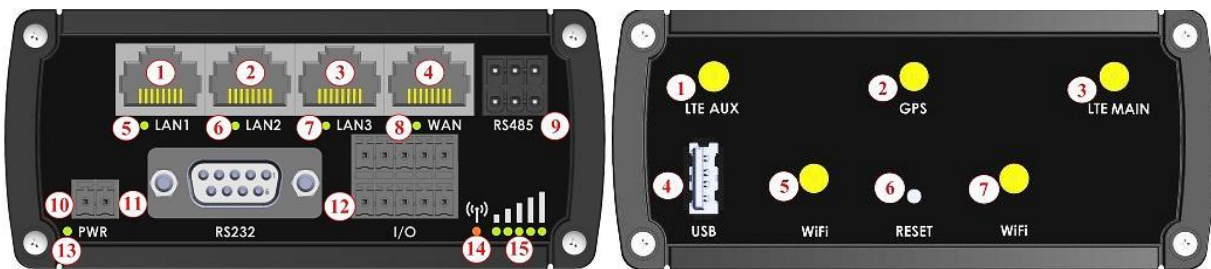

1,2,3	LAN Ethernet ports
4	WAN Ethernet port
5,6,7	LAN LEDs
8	WAN LED
9	RS485 connector
10	Power socket
11	RS232 connector
12	Inputs and outputs connector
13	Power LED
14	Connection LED
15	Signal strength LED

1	LTE auxiliary antenna connector
2	GPS antenna connector
3	LTE main antenna connector
4	USB connector
5,7	WiFi antenna connectors
6	Reset button

3.1.2 Connection status LED indication

Constant blinking (~ 2Hz) – router is turning on.

LED turned off – it has no 4G data connection

LED turned on – it has 4G data connection.

Explanation of connection status LED indication:

1. Green and red blinking alternatively ever 500 ms: no SIM or bad PIN;
2. Green, red and yellow blinking alternatively every 500 ms: connecting to GSM;
3. Red blinking every 1 sec: connected 2G, but no data session established;
4. Yellow blinking every 1 sec: connected 3G, no data session established;
5. Green blinking every 1 sec: connected 4G, no data session established;

Red lit and blinking rapidly while data is being transferred: connected 2G with data session;

Yellow lit and blinking rapidly while data is being transferred: connected 3G with data session;

Green lit and blinking rapidly while data is being transferred: connected 4G with data session;

3.1.3 Hardware installation

1. Remove back panel and insert SIM card which was given by your ISP (Internet Service Provider). Correct SIM card orientation is shown in the picture.

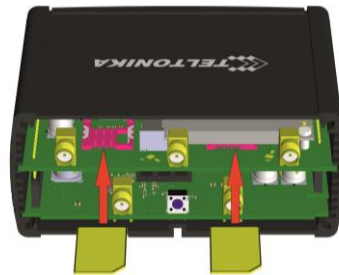

SIM 1 (primary)

SIM 2 (secondary)

2. Attach LTE main and Wi-Fi antennas.
3. Connect the power adapter to the socket on the front panel of the device. Then plug the other end of the power adapter into a wall outlet or power strip.
4. Connect to the device wirelessly (SSID: **Teltonika_Router**) or use Ethernet cable and plug it into any LAN Ethernet port.

3.2 Logging in

After you're complete with the setting up as described in the section above, you are ready to start logging into your router and start configuring it. This example shows how to connect on Windows 7. On windows Vista: click Start -> Control Panel -> Network and Sharing Centre -> Manage network Connections -> (Go to step 4). On Windows XP: Click Start -> Settings -> Network Connections -> (see step 4). You won't see "Internet protocol version 4(TCP/IPv4)", instead you'll have to select "TCP/IP Settings" and click options -> (Go to step 6)

We first must set up our network card so that it could properly communicate with the router.

1. Press the start button

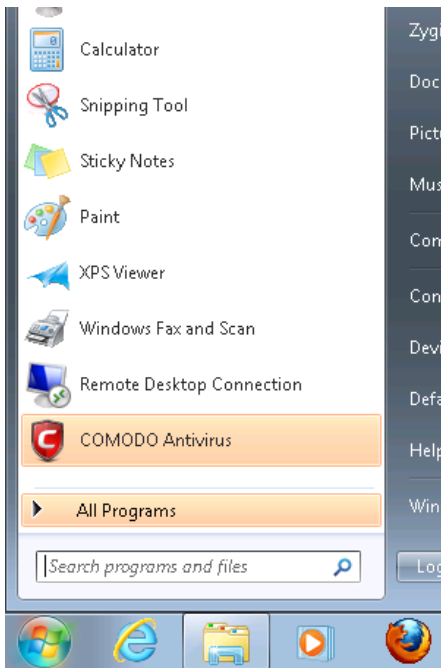

2. Type in "network connections", wait for the results to pop up.

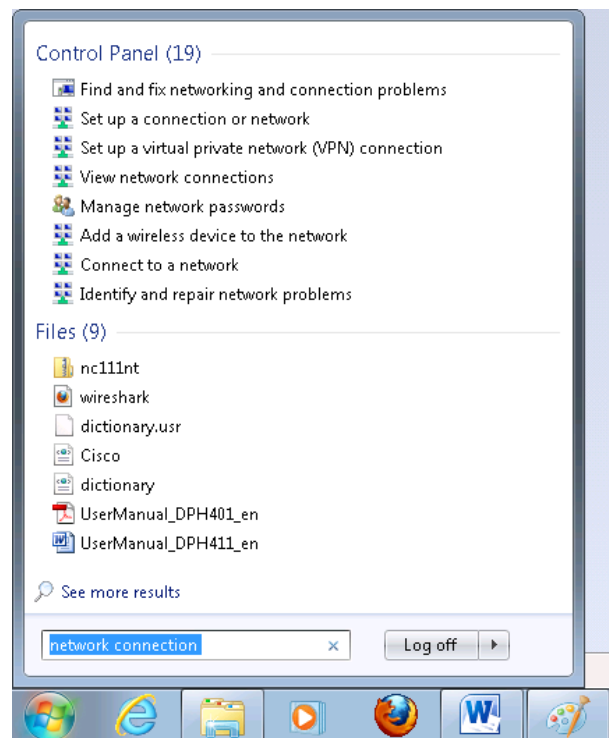

3. Click "View network connections"

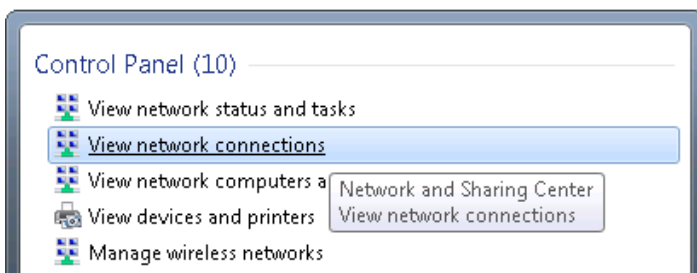

4. Then right click on your wireless device that you use to connect to other access points (It is the one with the name "Wireless Network Connection" and has signal bars on its icon).

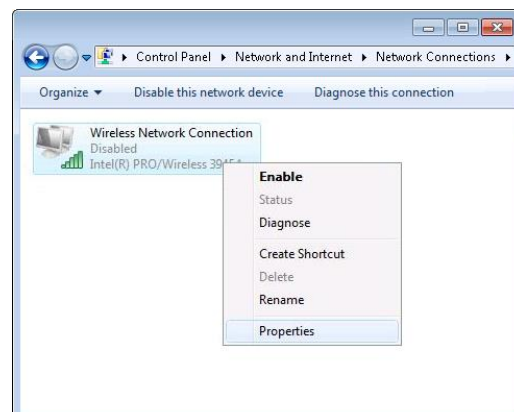

5. Select Internet Protocol Version 4 (TCP/IPv4) and then click Properties

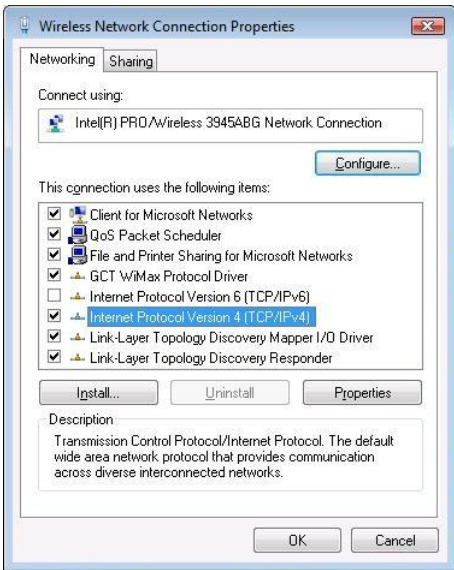

6. By default the router is going to have DHCP enabled, which means that if you select "Obtain an IP address automatically" and "Obtain DNS server address automatically", the router should lease you an IP and you should be ready to login.

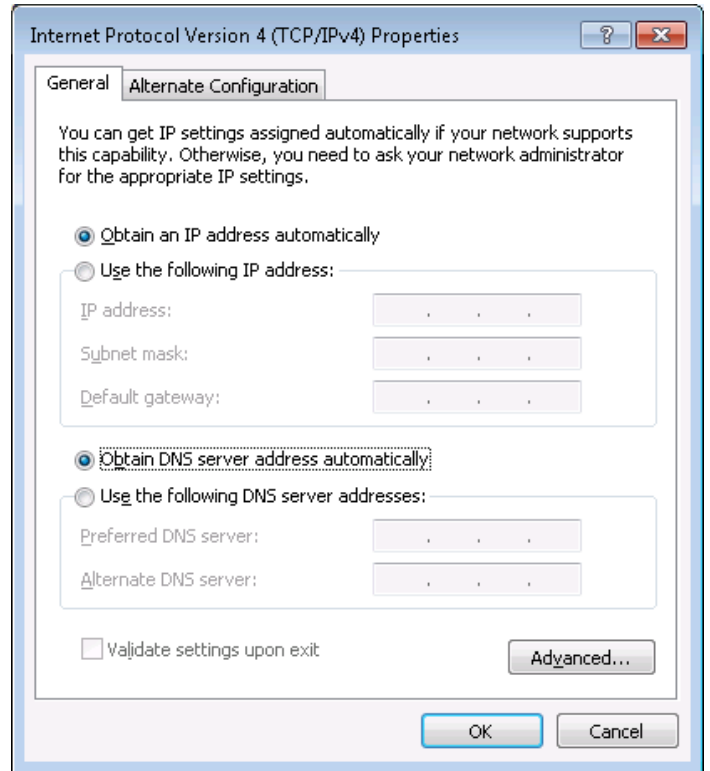

7. If you choose to configure manually here's what you do:

First select an IP address. Due to the stock settings that your router has arrived in you can only enter an IP in the form of 192.168.1.XXX , where XXX is a number in the range of 2-254 (192.168.1.2 , 192.168.1.254 , 192.168.1.155 and so on... are valid; 192.168.1.0 , 192.168.1.1 , 192.168.1.255 , 192.168.1.699 and so on... are not). Next we enter the subnet mask: this has to be "255.255.255.0". Then we enter the default gateway: this has to be "192.168.1.1". Finally we enter primary and secondary DNS server IPs. One will suffice, though it is good to have a secondary one as well as it will act as a backup if the first should fail. The DNS can be your routers IP (192.168.1.1), but it can also be some external DNS server (like the one Google provides: 8.8.8.8).

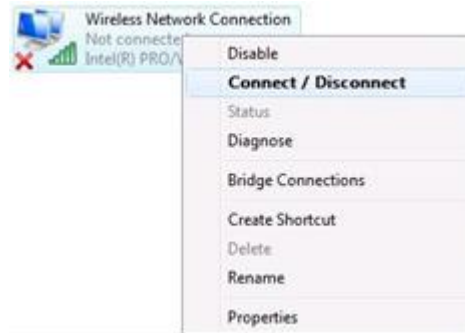
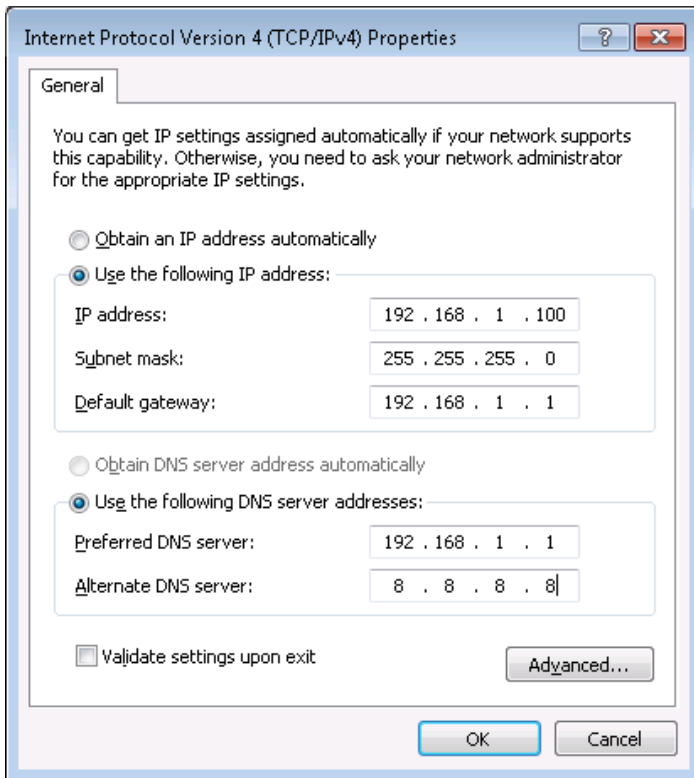

Right click on the Wireless network icon and select **Connect / Disconnect**. A list should pop up with all available wireless networks. Select “Teltonika” and click **connect**. Then we launch our favorite browser and enter the routers IP into the address field:



Press enter. If there are no problems you should be greeted with a login screen such as this:

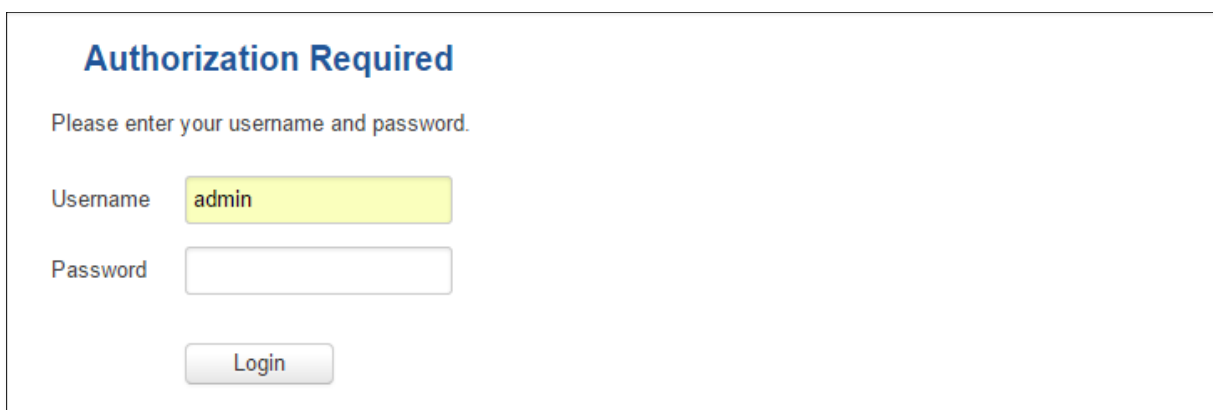

Enter the default password, which is “admin01” into the “Password” field and then either click Login with your mouse or press the Enter key. You have now successfully logged into the RUT955!

From here on out you can configure almost any aspect of your router.

4 Operation Modes

The RUT9xx series router supports various operation modes. It can be connected to the internet (WAN) via mobile, standard Ethernet cable or via a wireless network. When connecting to the internet, you may also backup your main WAN connection with one or two backup connections. Any interface can act like backup if configured so. At first router uses its main WAN connection, if it is lost then router tries to connect via backup with higher priority and if that fails too, router tries the second backup option.

WAN	Main WAN	Backup WAN	LAN
Mobile	√	√	x
Ethernet	√	√	√
Wi-Fi	√	√	√

In later sections it will be explained, in detail, how to configure your router to work in a desired mode.

5 Powering Options

The RUT9xx router can be powered from power socket or over Ethernet port. Depending on your network architecture you can use LAN 1 port to power the device.

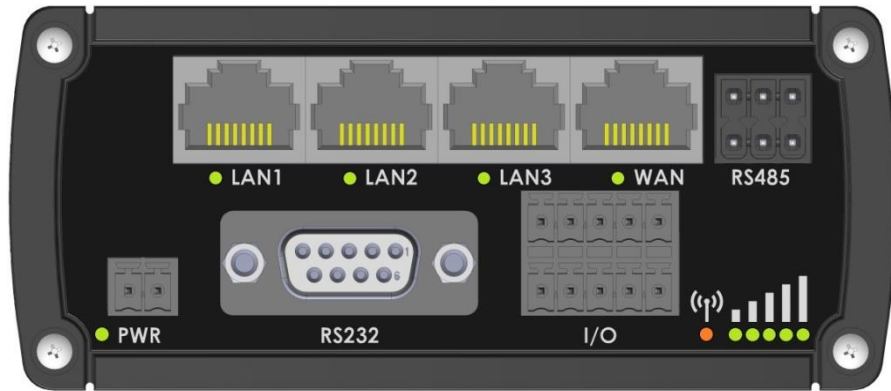

RUT9xx can be powered from power socket and over Ethernet simultaneously. Power socket has higher priority meaning that the device will draw power from power socket as long as it is available.

When RUT9xx is switching from one power source to the other it loses power for a fraction of the second and may reboot. The device will function correctly after the reboot.

Pin	Signal ID	T568A Color	T568B Color	Pins on plug face (socket is reversed)
1	TX+	white/green stripe	white/orange stripe	
2	TX-	green solid	orange solid	
3	RX+	white/orange stripe	white/green stripe	
4		blue solid	blue solid	
5	7 - 30VDC	white/blue stripe	white/blue stripe	
6	RX-	orange solid	green solid	
7	GROUND	white/brown stripe	white/brown stripe	
8	GROUND	brown solid	brown solid	

Though the device can be powered over Ethernet port it is not compliant with IEEE 802.3af-2003 standard. Powering RUT9xx from IEEE 802.3af-2003 power supply **will damage the device** as it is not rated for input voltages of PoE standard.

5.1 Powering the device from higher voltage

If you decide not to use our standard 9 VDC wall adapters and want to power the device from higher voltage (15 – 30 VDC) please make sure that you choose power supply of high quality. Some power supplies can produce voltage peaks significantly higher than the declared output voltage, especially during connecting and disconnecting them.

While the device is designed to accept input voltage of up to 30 VDC peaks from high voltage power supplies can harm the device. If you want to use high voltage power supplies it is recommended to also use additional safety equipment to suppress voltage peaks from power supply.

6 Status

The status section contains various information, like current IP addresses of various network interfaces; the state of the routers memory; firmware version; DHCP leases; associated wireless stations; graphs indicating load, traffic, etc.; and much more.

6.1 Overview

O Overview section contains various information summaries.

The screenshot displays the Teltonika router's status page. At the top, there is a navigation bar with the Teltonika logo and menu items: Status, Network, Services, System, and Logout. The main content area is titled 'Overview' and is divided into several sections:

- System:** Shows a 15.8% CPU load with a progress bar. Below this, it lists Router uptime (0d 4h 54m 33s), Local device time (2016-10-27, 11:41:21), Memory usage (RAM: 41% used, FLASH: 5% used), and Firmware version (Used: 51MB, Free: 72MB, Total: 123 MB).
- Mobile:** Shows a signal strength of -102 dBm. It lists Data connection (Disconnected), State (Searching; N/A; 3G (WCDMA)), SIM card slot in use (SIM 1 (not inserted)), and Bytes received/sent (0 B / 408 B).
- Wireless:** Shows the wireless interface is ON. It lists SSID (Teltonika_Router (AP)) and Mode (1- AP; 7 CH (2.442 GHz)).
- WAN:** Shows the WAN interface is Wired. It lists IP address (N/A) and Backup WAN status (Backup link is disabled).
- Local Network:** Shows IP / netmask (192.168.2.1 / 255.255.255.0) and Clients connected (0).
- Access Control:** Shows LAN access (SSH; HTTP; HTTPS) and WAN access (No access).
- Recent System Events:** Lists four events related to network configuration, Web UI authentication, and SSH password authentication.
- Recent Network Events:** Lists four events related to mobile data connection and joining 3G WCDMA.

At the bottom, there is a disclaimer: ** Your carrier's data usage accounting may differ. Teltonika is not liable should any accounting discrepancies occur.*

6.2 System Information

The System Information tab contains data that pertains to the routers operating system.

The screenshot shows the Teltonika web interface with the following system information:

System	
Router name	RUT955
Host name	Teltonika-RUT955.com
Router model	Teltonika RUT955 LTE
Firmware version	RUT9XX_R_00.02.376
Kernel version	3.10.36
Local device time	2016-05-24, 11:01:14
Uptime	0d 0h 42m 11s (since 2016-05-24, 10:19:03)
Load average	1 min: 99%; 5 mins: 63%; 15 mins: 35%
Temperature	34.9° C

Memory	
Free	84868 kB / 126556 kB (67%)
Cached	14740 kB / 126556 kB (11%)
Buffered	5476 kB / 126556 kB (4%)

System explanation:

	Field Name	Sample value	Explanation
1.	Router Name	RUT955	Name of the router (hostname of the routers system). Can be changed in System -> Administration.
2.	Host name	Teltonika-RUT955.com	Indicates how router will be seen by other devices on the network. Can be changed in System -> Administration.
3.	Router Model	Teltonika RUT955 LTE	Routers model.
4.	Firmware Version	RUT9XX_R_00.02.376	Shows the version of the firmware that is currently loaded in the router. Newer versions might become available as new features are added. Use this field to decide whether you need a firmware upgrade or not.
5.	Kernel Version	3.10.36	The version of the Linux kernel that is currently running on the router.
6.	Local Time	2016-05-24, 11:02:39	Shows the current system time. Might differ from your computer, because the router synchronizes its time with an NTP server.Format [year-month-day, hours:minutes:seconds].
7.	Uptime	0d 0h 44m 1s (since 2016-05-24, 10:19:03)	Indicates how long it has been since the router booted up. Reboots will reset this timer to 0.Format [day's hours minutes seconds (since year-month-day, hours: minutes: seconds)].
8.	Load Average	1 min: 88%; 5 mins: 73%; 15 mins: 42%	Indicates how busy the router is. Let's examine some sample output: "1 min: 88%, 5 mins: 73%, 15 mins: 42%". The first number mean past minute and second number means that in the past minute there have been, on average, 88% processes running or waiting for a resource.
9.	Temperature	34.9° C	Device's temperature

Memory explanation:

	Field Name	Sample Value	Explanation
1.	Free	84584 kB /126556 kB (66%)	The amount of memory that is completely free. Should this rapidly decrease or get close to 0, it would indicate that the router is running out of memory, which could cause crashes and unexpected reboots.

2.	Cached	14784 kB /126556 kB (11%)	The size of the area of memory that is dedicated to storing frequently accessed data.
3.	Buffered	5504 kB / 126556 kB (4%)	The size of the area in which data is temporarily stored before moving it to another location.

6.3 Network Information

6.3.1.1 Mobile

Display information about mobile modem connections.

Mobile Information	
SIM card slot in use: <i>SIM 1</i>	
Mobile 	
Data connection state	Connected
IMEI	860461024350889
IMSI	246012101426458
Sim card state	Ready
Signal strength	-88 dBm
Cell ID	2C86315
RSRP	-119 dBm
RSRQ	-11 dBm
SINR	-1.2 dBm
Operator	OMNITEL LT
Operator state	Registered (home)
Connection type	4G (LTE)
Bytes received *	39.9 KB (40832 bytes)
Bytes sent *	27.0 KB (27674 bytes)

Mobile information:

	Field Name	Sample Value	Explanation
1.	Data connection state	Connected	Mobile data connection status
2.	IMEI	860461024350889	Modem's IMEI (International Mobile Equipment Identity) number
3.	IMSI	246012101426458	IMSI (International Mobile Subscriber Identity) is used to identify the user in a cellular network
4.	SIM card state	Ready	Indicates the SIM card's state, e.g. PIN required, Not inserted, etc.
5.	Signal strength	-88 dBm	Received Signal Strength Indicator (RSSI). Signal's strength measured in dBm
6.	Cell ID	2C86315	ID of operator cell that device is currently connected to
7.	RSRP	-119 dBm	Indicates the Reference Signal Received Power
8.	RSRQ	-11 dBm	Indicates the Reference Signal Received Quality
9.	SINR	-1.2 dBm	Indicates the Signal to Interference plus Noise Ratio
10.	Operator	OMNITEL LT	Operator's name of the connected GSM network
11.	Operator state	Registered (home)	GSM network's status
12.	Connection type	4G (LTE)	Indicates the GSM network's access technology
13.	Bytes received	39.9 KB (40832 bytes)	How many bytes were received via mobile data connection

14.	Bytes sent	27.0 KB (27674 bytes)	How many bytes were sent via mobile data connection
-----	------------	-----------------------	---

6.3.1.2 WAN

Display information about WAN connection.

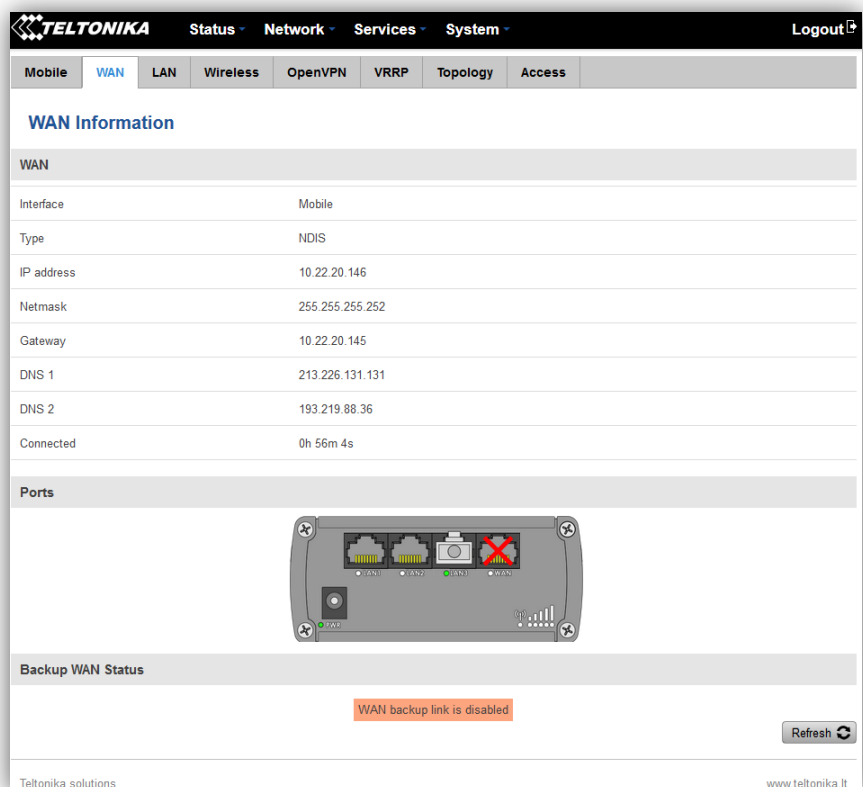

WAN information:

	Field Name	Sample Value	Explanation
1.	Interface	Mobile	Specifies through what medium the router is connecting to the internet. This can either be Wired, Mobile or Wi-Fi.
2.	Type	NDIS	Specifies the type of connection. This can either be static or DHCP.
3.	IP address	10.22.20.146	The IP address that the routers uses to connect the internet.
5.	Netmask*	255.255.255.252	Specifies a mask used to define how large the WAN network is
6.	Gateway*	10.22.20.145	Indicates the default gateway, an address where traffic destined for the internet is routed to.
7.	DNS*	213.226.131.131 / 193.219.88.36	Domain name server(s).
8.	Connected*	0h 56m 4s	How long the connection has been successfully maintained.

*-These fields show up on other connection modes.

**-Exclusive to other Modes with DHCP.

6.3.1.3 LAN

Display information about LAN connections.

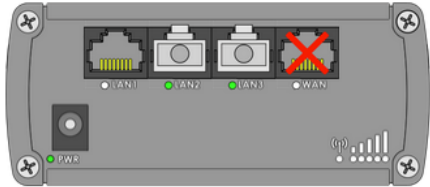
Mobile	WAN	LAN	Wireless	OpenVPN	VRRP	Topology	Access
LAN Information							
LAN Information							
Name	IP address	Netmask	Ethernet MAC address	Connected for			
Lan	192.168.99.218	255.255.255.0	00:1E:42:00:00:00	1h 53m 56s			
DHCP Leases							
Hostname	IP address	LAN name	MAC address	Lease time remaining			
?	192.168.99.120	Lan	D4:85:64:65:2B:D4	10h 11m 13s			
Ports							
							

LAN information:

	Field Name	Sample Value	Explanation
1.	Name	Lan	Lan instance name
2.	IP address	192.168.99.218	Address that the router uses on the LAN network.
3.	Netmask	255.255.255.0	A mask used to define how large the LAN network is
4.	Ethernet LAN MAC address	00:1E:42:00:00:00	MAC (Media Access Control) address used for communication in a Ethernet LAN (Local Area Network)
5.	Connected for	1h 53m 56s	How long LAN has been successfully maintained.

DHCP Leases

If you have enabled a DHCP server this field will show how many devices have received an IP address and what those IP addresses are.

	Field Name	Sample Value	Explanation
1.	Hostname	?	DHCP client's hostname
2.	IP address	192.168.99.120	Each lease declaration includes a single IP address that has been leased to the client
3.	Lan name	Lan	Lan instance name
4.	MAC address	D4:85:64:65:2B:D4	The MAC (Media Access Control) address of the network interface on which the lease will be used. MAC is specified as a series of hexadecimal octets separated by colons
5.	Lease time remaining	10h 11m 13s	Remaining lease time for addresses handed out to clients

6.3.1.4 Wireless

Wireless can work in two modes, Access Point (AP) or Station (STA). AP is when the wireless radio is used to create an Access Point that other devices can connect to. STA is when the radio is used to connect to an Access Point via WAN.

6.3.1.4.1 Station

Display information about wireless connection (Station mode).

Mobile	WAN	LAN	Wireless	OpenVPN	VRRP	Topology	Access
Wireless Information							
Wireless Information							
Channel		1 (2.41 GHz)					
Country code		00 (World)					
Wireless Status							
SSID	Mode	Encryption	Wireless MAC	Signal quality	Bit rate		
Teltonika_Router	Station (STA)	no encryption	00:1E:42:10:80:22	61%	43.3 MBit/s		
Teltonika_Router_Test	Access Point (AP)	no encryption	02:1E:42:00:11:03	79%	1.0 MBit/s		
Associated Stations							
MAC Address	Device Name	Signal	RX Rate	TX Rate			
00:1E:42:10:80:22	?	-67 dBm	1.0 Mbit/s, MCS 0, 20MHz	43.3 Mbit/s, MCS 10, 20MHz			
							Refresh 

Client mode information

	Field Name	Sample Value	Explanation
1.	Channel	1 (2.41 GHz)	The channel that the AP, to which the routers is connected to, uses. Your wireless radio is forced to work in this channel in order to maintain the connection.
2.	Country	00	Country code.
3.	SSID	Teltonika_Router	The SSID that the AP, to which the routers is connected to, uses.
4.	Mode	Station (STA)	Connection mode – Client indicates that the router is a client to some local AP.
5.	Encryption	WPA2 PSK (CCMP)	The AP, to which the router is connected to, dictates the type of encryption.
6.	Wireless MAC	00:1E:42:10:80:22	The MAC address of the access points radio.
7.	Signal Quality	61%	The quality between routers radio and some other device that is connecting to the router. Will show 0% if no devices are trying to connect or are currently maintaining a connection.
8.	Bit rate	43.3 MBit/s	The physical maximum possible throughput that the routers radio can handle. Keep in mind that this value is cumulative - The bitrate will be shared between the router and other possible devices that connect to the local AP.

6.3.1.4.2 Access Point

Displays information about wireless connection (Access Point mode).

Mobile	WAN	LAN	Wireless	OpenVPN	VRRP	Topology	Access
Wireless Information							
Wireless Information							
Channel	11 (2.46 GHz)						
Country code	00 (World)						
Wireless Status							
SSID	Mode	Encryption	Wireless MAC	Signal quality	Bit rate		
Teltonika_Router_Test	Access Point (AP)	no encryption	00:1E:42:00:11:03	80%	54.0 MBit/s		
Associated Stations							
MAC Address	Device Name	Signal	RX Rate	TX Rate			
FC:C2:DE:91:36:A6	android-9aed2b2077a54c74	-54 dBm	24.0 Mbit/s, MCS 0, 20MHz	54.0 Mbit/s, MCS 0, 20MHz			
Refresh 							

Wireless AP information

	Field Name	Sample Value	Explanation
1.	Channel	11 (2.46 GHz)	The channel which is used to broadcast the SSID and to establish new connections to devices.
2.	Country code	00(World)	Country code.
3.	SSID	Teltonika_Router_Test	The SSID that is being broadcast. Other devices will see this and will be able to use to connect to your wireless network.
4.	Mode	Access Point (AP)	Connection mode – Master indicates that you router is an access point.
5.	Encryption	No Encryption	The type of encryption that the router will use to authenticate, establish and maintain a connection.
6.	Wireless MAC	00:1E:42:00:00:03	MAC address of your wireless radio.
7.	Signal Quality	80%	The quality between routers radio and some other device that is connecting to the router. Will show 0% if no devices are trying to connect or are currently maintaining a connection.
8.	Bit rate	54.0 MBit/s	The bitrate will be shared between all devices that connect to the routers wireless network.

Additional note: MBit/s indicates the bits not bytes. To get the throughput in bytes divide the bit value by 8, for e.g. 54Mbits/s would be 6.75MB/s (Mega Bytes per second).

6.3.1.5 Associated Stations

Outputs a list of all devices and their MAC addresses that are maintain a connection with your router right now.

This can either be the information of the Access Point that the router is connecting to in STA mode or a list of all devices that are connecting to the router in AP mode:

	Field Name	Sample Value	Explanation
1.	MAC Address	FC:C2:DE:91:36:A6	Associated station's MAC (Media Access Control) address
2.	Device Name	Android-9aed2b2077a54c74	DHCP client's hostname
3.	Signal	-54dBm	Received Signal Strength Indicator (RSSI). Signal's strength measured

			in dBm
4.	RX Rate	24.0Mbit/s, MCS 0, 20MHz	The rate at which packets are received from associated station
5.	TX Rate	54.0Mbit/s, MCS 0, 20MHz	The rate at which packets are sent to associated station

6.3.1.6 OpenVPN Client

Display OpenVPN connection information on client side.

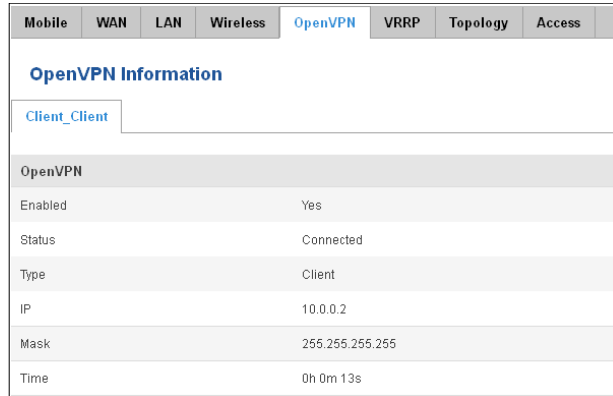

	Field Name	Sample Value	Explanation
1.	Enabled	Yes/No	OpenVPN status
2.	Status	Connected	Connection status
3.	Type	Client	A type of OpenVPN instance that has been created
4.	IP	10.0.0.2	Remote virtual network's IP address
5.	Mask	255.255.255.255	Remote virtual network's subnet mask
6.	Time	0h 0m 13s	For how long the connection has been established

6.3.1.7 OpenVPN Server

Display OpenVPN connection information on server side.

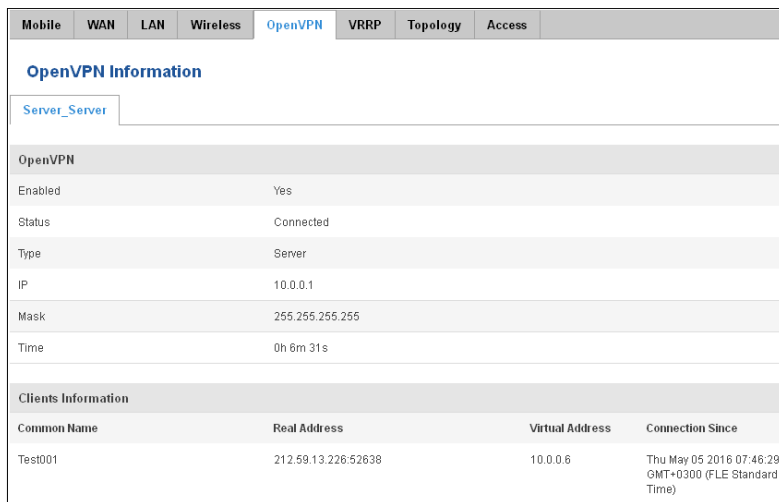

	Field Name	Sample Value	Explanation
1.	Enabled	Yes/No	OpenVPN status
2.	Status	Connected	Connection status

2.	Type	Server	A type of OpenVPN instance that has been created
3.	IP	10.0.0.1	Remote virtual network's IP address
4.	Mask	255.255.255.255	Remote virtual network's subnet mask
5.	Time	0h 3m 24s	For how long the connection has been established

6.3.1.8 Clients information

It will show information, when router is configured as OpenVPN TLS server.

	Field Name	Sample Value	Explanation
1.	Common Name	Test001	Client connection
2.	Real Address	212.59.13.225:52638	Client's IP address and port number
3.	Virtual Address	10.0.0.6	Virtual address which has been given to a client
4.	Connection Since	Thu May 05 2016 07:46:29 GMT + 0300 (FLE Standard Time)	Since when connection has been established

6.3.1.9 VRRP

VRRP (Virtual Router Redundancy Protocol) for LAN

The screenshot shows a web interface with several tabs: Mobile, WAN, LAN, Wireless, OpenVPN, VRRP, Topology, and Access. The VRRP tab is selected. Below the tabs, there is a section titled 'VRRP Information'. Underneath, there is a sub-section 'VRRP LAN Status' with the following details:

- Status: Enabled
- Virtual ip: 192.168.1.253
- Priority: 100
- Router: Master

A 'Refresh' button with a circular arrow icon is located at the bottom right of the VRRP information section.

	Field Name	Sample Value	Explanation
1.	Status	Enabled	VRRP status
2.	Virtual IP	192.168.1.253	Virtual IP address(- es) for LAN's VRRP (Virtual Router Redundancy Protocol) cluster
3.	Priority	100	Router with highest priority value on the same VRRP (Virtual Router

			Redundancy Protocol) cluster will act as a master, range [1 - 255]
4.	Router**	Master	Connection mode – Master

**-Exclusive to other Modes with Slave.

6.3.1.10 Topology

Network scanner allows you to quickly retrieve information about network devices. When router is configured to use Mobile as WAN and Connection type is selected „PPP“, then possible to scan only the LAN side.

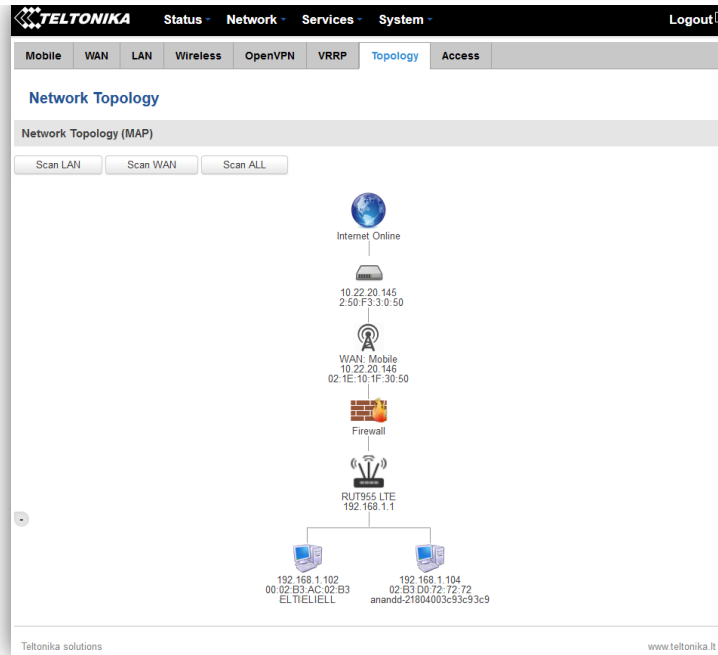

6.3.1.11 Access

Display information about local and remote active connections status.

Mobile	WAN	LAN	Wireless	OpenVPN	VRRP	Topology	Access
Access Status							
Access information Last Connections							
Local Access							
Type	Status	Port	Active Connections				
SSH	Enabled	22	0 (0.00 B)				
HTTP	Enabled	80	1 (9.26 KB)				
HTTPS	Enabled	443	0 (0.00 B)				
Remote Access							
Type	Status	Port	Active Connections				
SSH	Disabled	22	0 (0.00 B)				
HTTP	Disabled	80	0 (0.00 B)				
HTTPS	Enabled	443	6 (558.12 KB)				
Refresh ↻							

	Field Name	Sample Value	Explanation
1.	Type	SSH; HTTP; HTTPS	Type of connection protocol
2.	Status	Disabled/Enabled	Connection status
3.	Port	22; 80; 443	Connection port used
4.	Active	0(0.00B);1(9.26 KB);	Count of active connections and amount of data transmitted in KB

Connections 6(558.12 KB)

**-Exclusive to other Modes with Slave.

6.3.1.11.1 Last Connections

Displays information about local and remote last 3 connections status

Access Status			
Access Information		Last Connections	
Last Local Connections			
Type	Date	IP	Authentications Status
SSH	2016-03-03, 13:40:59	192.168.2.10	Succeeded
	2016-03-03, 13:47:44	192.168.2.10	Succeeded
	2016-03-09, 08:59:41	192.168.1.214	Succeeded
HTTP	2016-03-09, 08:30:04	192.168.1.214	Succeeded
	2016-03-09, 13:52:08	192.168.1.214	Succeeded
	2016-03-09, 08:26:16	192.168.1.214	Succeeded
HTTPS	<i>There are no records yet.</i>		
Last Remote Connections			
Type	Date	IP	Authentications Status
SSH	2016-03-07, 07:57:51	212.59.13.226	Succeeded
	2016-03-07, 08:41:46	119.167.153.187	Failed
	2016-03-07, 08:41:55	119.167.153.187	Failed
HTTP	2016-03-07, 07:56:06	10.8.32.1	Succeeded
	2016-03-07, 07:57:15	212.59.13.226	Succeeded
	2016-03-09, 14:13:05	10.8.32.1	Succeeded
HTTPS	<i>There are no records yet.</i>		

	Field Name	Sample Value	Explanation
1.	Type	SSH; HTTP; HTTPS	Type of connection protocol
2.	Date	2016-03-03, 13:40:59	Date and time of connection
3.	IP	192.168.2.10	IP address from which the connection was made
4.	Authentications Status	Failed; Succeed	Status of authentication attempt

6.4 Device information

The page displays factory information that was written into the device during manufacturing process.

Device Information

Device

Serial number	15981598
Product code	RUT95517V000
Batch number	1010
Hardware revision	0202
IMEI	860425471954719
IMSI	246022547254719
Ethernet LAN MAC address	00:1E:42:10:42:00
Ethernet WAN MAC address	00:1E:42:10:42:01
Wireless MAC address	00:1E:42:10:42:02

Modem

Model	ME909u-521
FW version	12.631.07.01.00

	Field Name	Sample Value	Explanation
1.	Serial number	15981598	Serial number of the device
2.	Product code	RUT95517V000	Product code of the device
3.	Batch number	1010	Batch number used during device's manufacturing process
4.	Hardware revision	0202	Hardware revision of the device
5.	IMEI	860425471954819	Identification number of the internal modem
6.	IMSI	246022547254719	Subscriber identification number of the internal modem
6.	Ethernet LAN MAC	00:1E:42:10:42:00	MAC address of the Ethernet LAN ports
7.	Ethernet WAN MAC	00:1E:42:10:42:01	MAC address of the Ethernet WAN port
8.	Wireless MAC	00:1E:42:10:42:02	MAC address of the Wi-Fi interface
9.	Model	ME909-521	Router's modem model
10.	FW version	12.631.07.01.00	Router's modem firmware version

6.5 Services

The page displays usage of the available services.

Services Status		
VRRP LAN	Disabled	Restart
OpenVPN servers	Disabled	Restart
OpenVPN clients	Disabled	Restart
SNMP agent	Disabled	Restart
SNMP trap	Disabled	Restart
NTP client	Enabled	Restart
IPsec	Disabled	Restart
Ping reboot	Disabled	Restart
Input/Output rules	Disabled	Restart
DDNS	Disabled	Restart
Site blocking	Disabled	Restart
Content blocker	Disabled	Restart
SMS utils rules	Enabled	Restart
Hotspot	Disabled	Restart
Hotspot logging	Disabled	Restart
GRE tunnel	Disabled	Restart
QoS	Disabled	Restart
GPS	Disabled	Restart

Refresh

1.1 Routes

The page displays ARP table and active IP routes of the device.

6.5.1 ARP

Show the routers active ARP table. An ARP table contains recently cached MAC addresses of every immediate device that was communicating with the router.

ARP		
IP Address	MAC Address	Interface
10.0.207.217	02:50:F3:00:00:00	eth2
192.168.99.17	00:25:22:D7:CA:A7	br-lan
192.168.99.36	38:2C:4A:64:2D:E5	br-lan
192.168.99.155	00:00:00:00:00:00	br-lan

	Field Name	Sample Value	Explanation
1.	IP Address	192.168.99.17	Recently cached IP addresses of every immediate device that was communicating with the router
2.	MAC Address	00:25:22:D7:CA:A7	Recently cached MAC addresses of every immediate device that was communicating with the router
3.	Interface	br-lan	Interface used for connection

6.5.2 Active IP-Routes

Show the routers routing table. The routing table indicates where a TCP/IP packet, with a specific IP address, should be directed to.

Active IP Routes			
Network	Target	IP Gateway	Metric
ppp	0.0.0.0/0	10.0.207.217	0
ppp	10.0.207.216/29	0.0.0.0	0
ppp	10.0.207.217	0.0.0.0	0
lan	192.168.99.0/24	0.0.0.0	0

	Field Name	Sample Value	Explanation
1.	Network	ppp	Interface to be used to transmit TCP/IP packets through
2.	Target	192.168.99.0/24	Indicates where a TCP/IP packet, with a specific IP address, should be directed
3.	IP Gateway	0.0.0.0	Indicates through which gateway a TCP/IP packet should be directed
4.	Metric	0	Metric number indicating interface priority of usage

6.5.3 Active IPv6-Routes

Display active IPv6 routes for data packet transition.

Active IPv6-Routes			
Network	Target	IPv6-Gateway	Metric
loopback	0:0:0:0:0:0:0:0/0	0:0:0:0:0:0:0:0/0	FFFFFFFF
loopback	0:0:0:0:0:0:0:0/0	0:0:0:0:0:0:0:0/0	FFFFFFFF
loopback	0:0:0:0:0:0:0:1	0:0:0:0:0:0:0:0/0	00000000
ppp	FF00:0:0:0:0:0:0:0/8	0:0:0:0:0:0:0:0/0	00000100
loopback	0:0:0:0:0:0:0:0/0	0:0:0:0:0:0:0:0/0	FFFFFFFF

	Field Name	Sample Value	Explanation
1.	Network	loopback	Network interface used
2.	Target	0:0:0:0:0:0:0:0/0	Indicates where a TCP/IP packet, with a specific IP address, should be directed
3.	IPv6-Gateway	0:0:0:0:0:0:0:0/0	Indicates through which gateway a TCP/IP packet should be directed
4.	Metric	FFFFFFFF	Metric number indicating interface priority of usage

6.6 Graphs

Real-time graphs show how various statistical data changes over time.

6.6.1 Mobile Signal Strength

Displays mobile signal strength variation in time (measured in dBm)

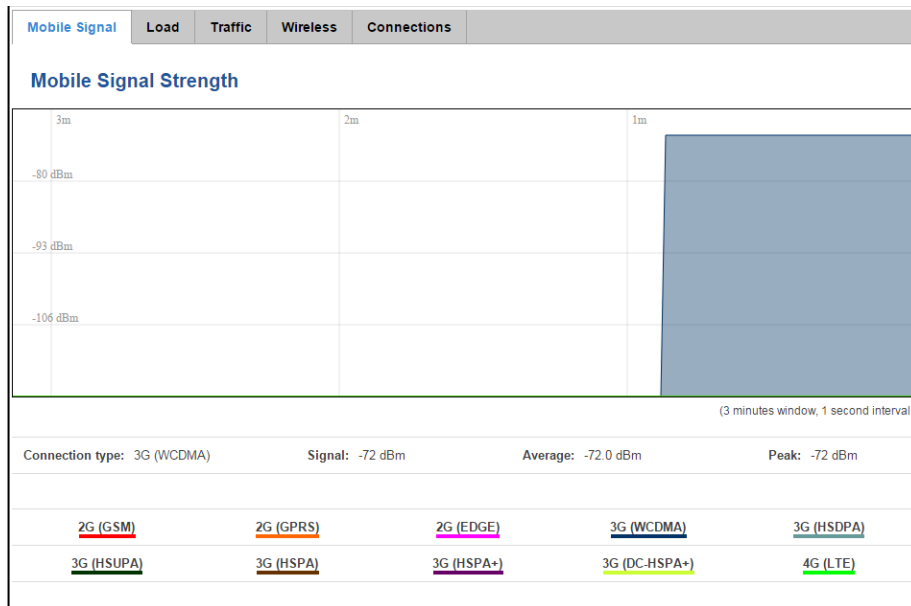

	Field Name	Sample Value	Explanation
1.	Connection type	3G (WCDMA)	Type of mobile connection used
2.	Signal	-72 dBm	Current signal strength value
3.	Average	-72.0 dBm	Average signal strength value
4.	Peak	-72 dBm	Peak signal strength value

6.6.2 Realtime Load

This tri-graph illustrates average CPU load values in real time. The graph consists out of three color coded graphs, each one corresponding to the average CPU load over 1 (red), 5 (orange) and 15 (yellow) most recent minutes.

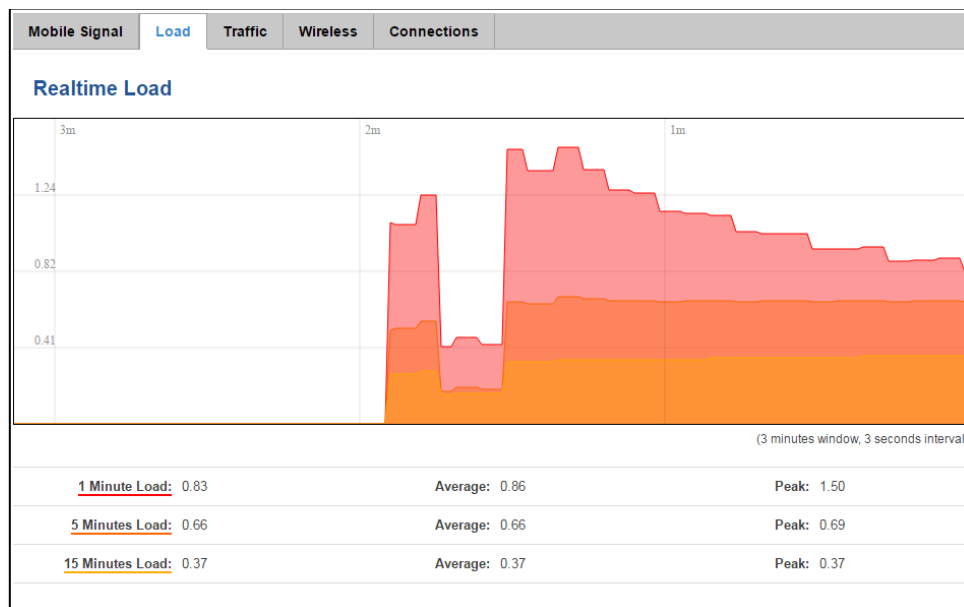

	Field Name	Sample Value	Explanation
1.	1/5/15 Minutes Load	0.83	Time interval for load averaging, colour of the diagram
2.	Average	0.86	Average CPU load value over time interval (1/5/15 Minute)
3.	Peak	1.50	Peak CPU load value of the time interval

6.6.3 Realtime Traffic

This graph illustrates average system inbound and outbound traffic over the course of ~3 minutes; each new measurement is taken every 3 seconds. The graph consists out of two colors coded graphs (green graph shows the outbound traffic, blue graph shows inbound traffic). Although not graphed, the page also displays peak loads and average of inbound and outbound traffic.

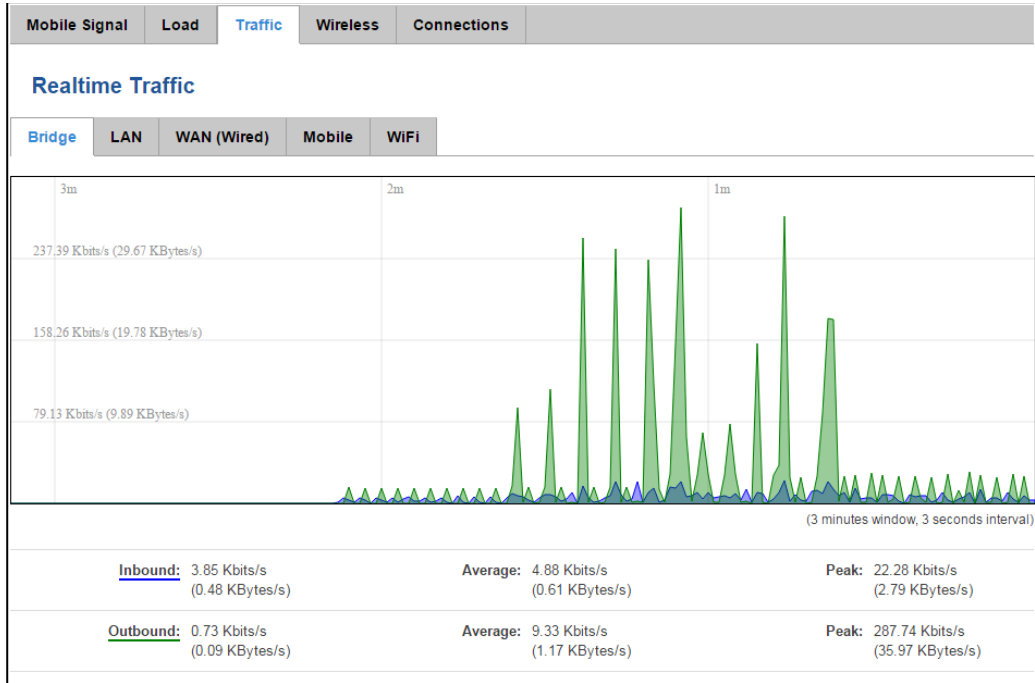

	Field Name	Explanation
1.	Bridge	Cumulative graph, which encompasses wired Ethernet LAN and the wireless network.
2.	LAN	Graphs the total traffic that passes through both LAN network interfaces.
3.	WAN (Wired)	Graphs the amount of traffic which passed through the current active WAN connection.
4.	Mobile	Graphs the amount of traffic which passed through the mobile network connection.
5.	Wi-Fi	Shows the amount of traffic that has been sent and received through the wireless radio.

6.6.4 Realtime Wireless

Display the wireless radio signal, signal noise and theoretical maximum channel permeability. Average and peak signal levels are displayed.

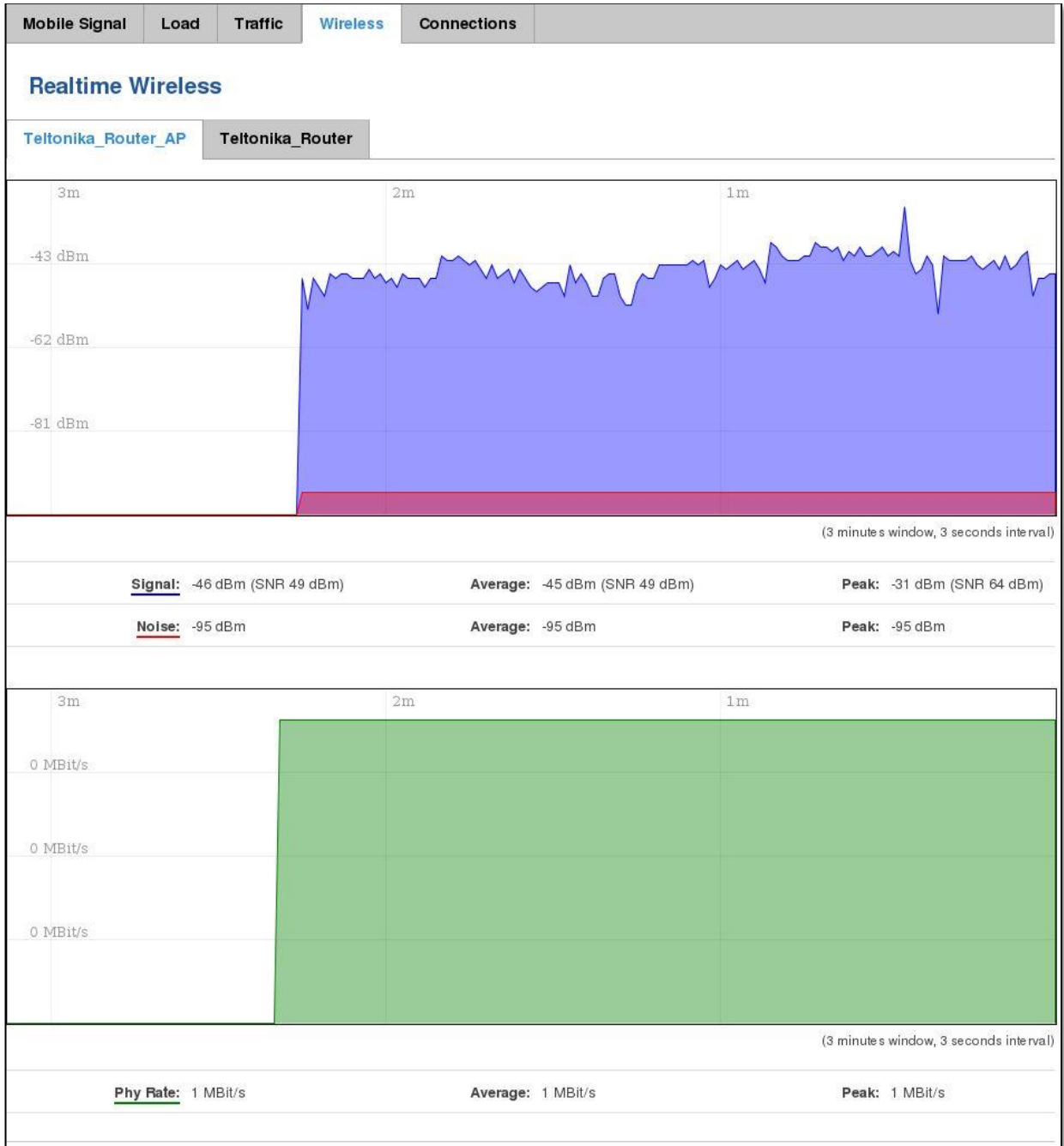

6.6.5 Realtime Connections

Displays currently active network connections with the information about network, protocol, source and destination addresses, transfer speed.

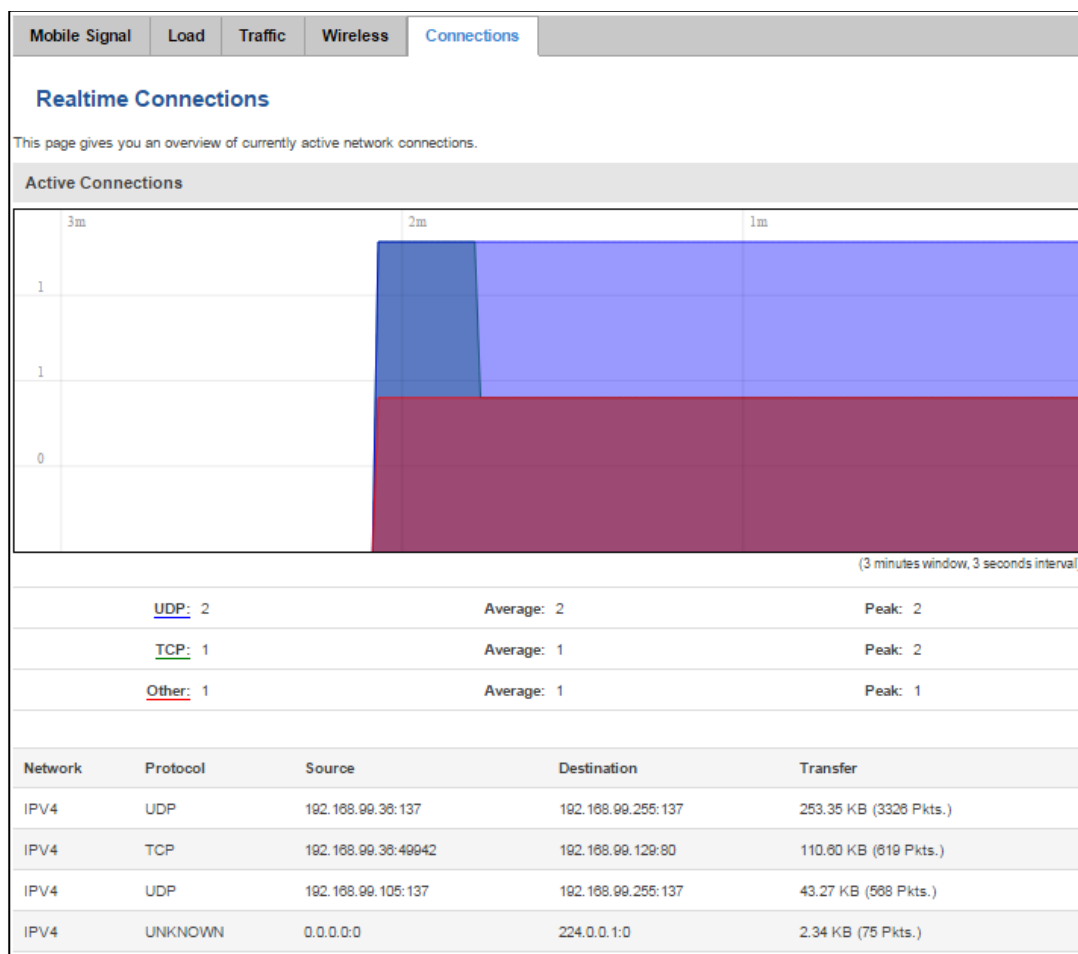

6.7 Mobile Traffic

Displays mobile connection data sent and received in KB of this day, week, Month.

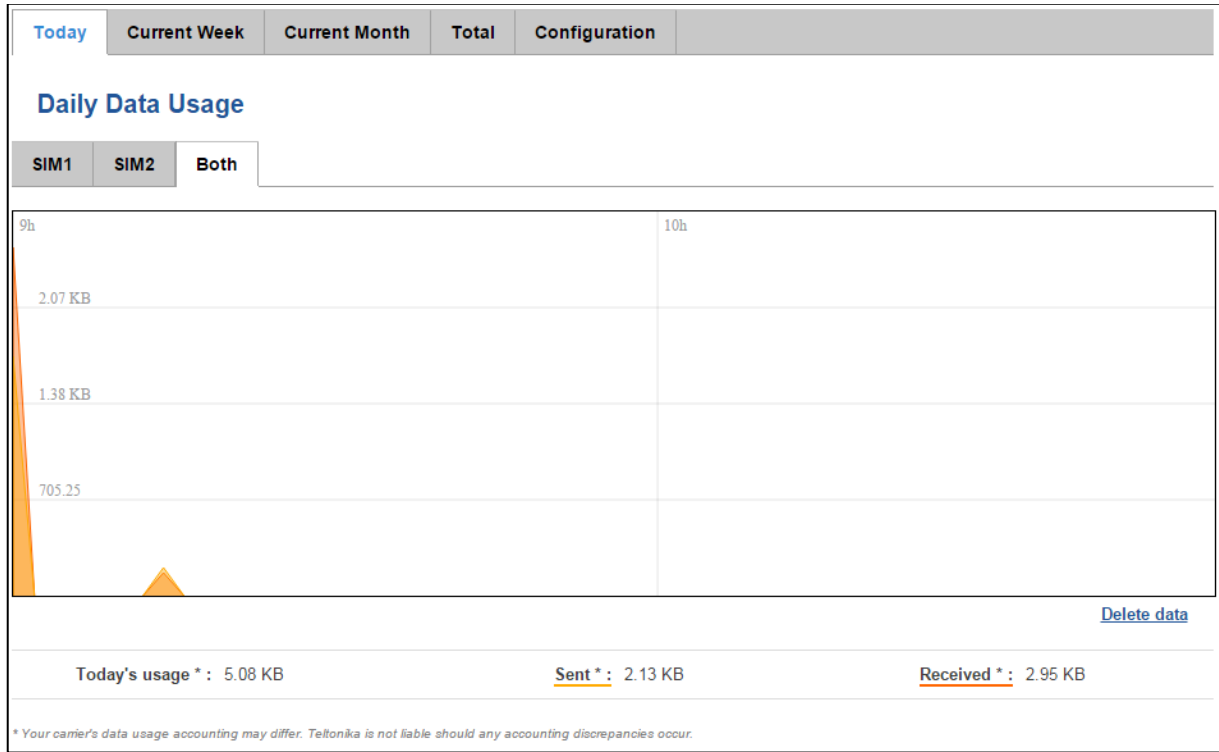

By default mobile traffic usage logging is disabled. To use this functionality is needed to enable it.

The screenshot shows the 'Mobile Traffic Usage Logging' configuration page. The header includes the Teltonika logo and navigation tabs: 'Status', 'Network', 'Services', 'System', and 'Logout'. Below the header, there are tabs for 'Today', 'Current Week', 'Current Month', 'Total', and 'Configuration'. The main section is titled 'Mobile Traffic Usage Logging' and contains an 'Enable' checkbox (checked) and an 'Interval between records (sec)' input field set to 60. A 'Save' button is at the bottom right.

	Field Name	Sample Value	Explanation
1.	Enable	Enable/Disable	Make a functionality active/inactive
2.	Interval between records (sec)	60	The interval between logging records (minimum 60 sec)

6.8 Speed Test

Speed test is a tool for measuring your internet connection upload and download speeds. You can select servers for manual testing, or use auto test.

Speed Test

Speedometer: 0.00 Mbits/s

Buttons: Begin auto test, Get servers list, Test again

Server	Penki Kontinentai Vilnius Lith...
Ping	16 ms
Download speed	18.66 Mbits/s
Upload speed	4.63 Mbits/s

Server 1	Begin test
Server 2	Begin test
Server 3	Begin test
Server 4	Begin test

6.9 Events Log

Event log displays such actions as: login, reboot, firmware flashing and reset.

6.9.1 All Events

Display all router events, their types and time of occurrence.

Navigation: All Events, System Events, Network Events, Events Reporting, Reporting Configuration

Events Log

Events per page: 10 | Search:

ID	Date	Event type	Event
3181S	2015-05-11, 16:11:47	Config	Firewall configuration has been changed
3180S	2015-05-11, 16:09:29	Port	Wired WAN connection operational
3179S	2015-05-11, 16:05:13	Port	Wired WAN connection non operational
3178S	2015-05-11, 16:02:39	DHCP	Leased 192.168.1.232 IP address for client FC:C2:DE:91:36:A6 - android-9aed2b2077a54c74 in WiFi
3177S	2015-05-11, 16:02:39	Port	Wired WAN connection operational
3176S	2015-05-11, 16:02:38	DHCP	Leased 192.168.1.232 IP address for client FC:C2:DE:91:36:A6 - android-9aed2b2077a54c74 in WiFi
3175S	2015-05-11, 16:02:37	DHCP	Leased 192.168.1.232 IP address for client FC:C2:DE:91:36:A6 - android-9aed2b2077a54c74 in WiFi
3174S	2015-05-11, 16:02:36	DHCP	Leased 192.168.1.232 IP address for client FC:C2:DE:91:36:A6 - android-9aed2b2077a54c74 in WiFi
3173S	2015-05-11, 16:02:36	DHCP	Leased 192.168.1.232 IP address for client FC:C2:DE:91:36:A6 - android-9aed2b2077a54c74 in WiFi
3172S	2015-05-11, 16:02:35	DHCP	Leased 192.168.1.232 IP address for client FC:C2:DE:91:36:A6 - android-9aed2b2077a54c74 in WiFi

Showing 1 to 10 of 1912 entries | [Next >>](#)

6.9.2 System Events

Display all system events, their type and time of occurrence. Events include authentication or reboot requests, incoming and outgoing SMS and calls, Mails, Configuration changes, DHCP events.

System Log						
All	Authentication	Reboot	SMS/Call	Mail	Configuration	DHCP
Events Log						
Events per page		10	Search		<input type="text"/>	
ID	Date	Event type	Event			
1040	2016-03-10, 08:53:01	Web UI	Authentication was succesful from HTTP LAN 192.168.1.214			
1039	2016-03-10, 08:48:47	Config	Firewall configuration has been changed			
1038	2016-03-09, 09:35:29	DHCP	Leased 192.168.1.214 IP address for client 00:11:25:A2:A0:7A - user in LAN			
1037	2016-03-09, 09:35:27	DHCP	Leased 192.168.1.214 IP address for client 00:11:25:A2:A0:7A - user in LAN			
1036	2016-03-09, 09:35:24	Port	Wired WAN connection operational			
1035	2016-03-09, 09:34:28	Config	Hotspot configuration has been changed			
1034	2016-03-09, 09:34:18	DHCP	Leased 192.168.1.214 IP address for client 00:11:25:A2:A0:7A - user in LAN			

6.9.3 Network Events

Display information about recent network events like connection status change, lease status change, network type or operator change.

All Events | **System Events** | **Network Events** | **Events Reporting** | **Reporting Configuration**

Connections Log

All | **Wireless** | **Mobile Data** | **Network Type** | **Network Operator**

Events per page: 10

ID	Date	Action	Result
312	2015-05-11 15:48:49	WiFi	WiFi client connected: FC:C2:DE:91:36:A6 android-9aed2b2077a54c74
311	2015-05-11 15:48:43	WiFi	WiFi client disconnected: FC:C2:DE:91:36:A6 android-9aed2b2077a54c74
310	2015-05-11 15:48:37	WiFi	WiFi client connected: FC:C2:DE:91:36:A6 android-9aed2b2077a54c74
309	2015-05-11 15:48:31	WiFi	WiFi client disconnected: 20:34:47:41:4B:45
308	2015-05-11 15:36:56	WiFi	WiFi client connected: 20:34:47:41:4B:45
307	2015-05-11 15:36:55	WiFi	WiFi client disconnected: 00:1E:42:10:80:22
306	2015-05-11 15:30:32	WiFi	WiFi client connected: 00:1E:42:10:80:22
305	2015-05-11 15:30:26	WiFi	WiFi client disconnected: 00:1E:42:10:80:22
304	2015-05-11 15:19:58	WiFi	WiFi client connected: 00:1E:42:10:80:22
303	2015-05-11 15:19:52	WiFi	WiFi client disconnected: FC:C2:DE:91:36:A6 android-9aed2b2077a54c74

Showing 1 to 10 of 312 entries [Next >>](#)

6.9.4 Events Reporting

Allow to view, enable/disable or modify created rules for events reporting.

6.9.4.1 Events Reporting Configuration

Allow to review created rules details and modify them, so after event occurrence, messages or emails are sent to specified address or phone numbers with information about the event.

Field Name	Sample Value	Explanation
------------	--------------	-------------

1.	Enable	Enable/Disable	Make a rule active/inactive
2.	Event type	Reboot	Select event type about which occurrence information will be sent
3.	Event subtype	After unexpected shut down	Specify event subtype to activate the rule
4.	Event subtype	All/Loaded	Event subtype for which the rule is applied
5.	Action	Send SMS	Action to perform when an event occurs
6.	Enable delivery retry	Enable/Disable	Enables to send SMS again if first try to send SMS was unsuccessful.
7.	Message text on Event	Router name - %rn; Event type - %et; Event text - %ex; Time stamp - %ts;	Message text on specific event
8.	Get status after reboot	Enable/Disable	Receive router status information after reboot
9.	Recipient's phone number	+123456789	For whom you want to send a SMS

6.9.5 Reporting Configuration

Displays configured services for event reporting, allows enabling, disabling, viewing and modifying parameters.

The screenshot shows a web interface for 'Reporting Configuration'. It features a navigation bar with tabs: 'All Events', 'System Events', 'Network Events', 'Events Reporting', and 'Reporting Configuration'. Below the navigation, there is a section titled 'Events Log Files Report' with the instruction 'Create rules for Events Log reporting.' A table titled 'Events Log Report Rules' contains two entries: 'System' with 'Email' transfer type and 'Network' with 'FTP' transfer type. Both rules are enabled (checked) and have 'Sort' buttons. Below the table, a note states '* All rules are executed in current list order.' At the bottom, there is an 'Events Log Reporting Configuration' section with dropdown menus for 'Events log' (set to 'System') and 'Transfer type' (set to 'Email'), and an 'Add' button.

6.9.5.1 Events Log Report Configuration

Allow to change the configuration of periodic events reporting to email or FTP.

FTP:

All Events
System Events
Network Events
Events Reporting
Reporting Configuration

Events Log Report Configuration

Modify events log file report rule

Enable

Events log System ▼

Transfer type FTP ▼

Compress file

Host

User name

Password

Interval between reports Week ▼

Weekday Monday ▼

Hour 12 ▼

	Field Name	Sample Value	Explanation
1.	Enable	Enable/Disable	Make a rule active/inactive
2.	Events log	System	Events log for which the rule is applied
3.	Transfer type	FTP	Events log file transfer type: Email/FTP
4.	Compress file	Enable	Enable/disable compress events log file using gzip
5.	Host	192.168.123.123	FTP (File Transfer Protocol) host name, e.g. ftp.example.com , 192.168.123.123. Allowed characters (a-z-A-Z0-9!@#\$\$%^&*+/-=?_`{ }~.)
6.	User name	Username	User name for authentication on SMTP (Simple Mail Transfer Protocol) or FTP (File Transfer Protocol) server. Allowed characters (a-z-A-Z0-9!@#\$\$%^&*+/-=?_`{ }~.)
7.	Password	password	Password for authentication on SMTP (Simple Mail Transfer Protocol) or FTP (File Transfer Protocol) server. Allowed characters (a-z-A-Z0-9!@#\$\$%^&*+/-=?_`{ }~.)
8.	Interval between reports	Week	Send report every selected time interval
9.	Weekday	Monday	Day of the week to get events log report
10.	Hour	12	Hour of the day to get events log report

Email:

Modify events log file report rule

Enable

Events log

Transfer type

Compress file

Subject

Message

SMTP server

SMTP server port

Secure connection

User name

Password

Sender's email address

Recipient's email address

Interval between reports

Weekday

Hour

	Field Name	Sample Value	Explanation
1.	Enable	Enable/Disable	Make a rule active/inactive
2.	Events log	System	Event log for which the rule is applied
3.	Transfer type	Email	Events log file transfer type: Email/FTP
4.	Compress file	Enable	Enable/disable compress events log file using gzip
5.	Subject	Subject	Subject of an email
6.	Message	YourMessage	Message to send in email
7.	SMTP server	smtp.gmail.com	SMTP (Simple Mail Transfer Protocol) server address
8.	SMTP server port	25	SMTP (Simple Mail Transfer Protocol) server port
9.	Secure connection	Enable/Disable	Enables/disables secure connection. Use only if server supports SSL or TLS
10.	User name	User	User name for authentication on SMTP (Simple Mail Transfer Protocol)
11.	Password	••••••	User password for authentication on SMTP (Simple Mail Transfer Protocol)
12.	Sender's email address	senderemail@example.com	An address that will be used to send your email from. Allowed characters (a-zA-Z0-9._%+-)
13.	Recipient's email address	recipientemail@example.com	For whom you want to send an email to. Allowed characters (a-zA-Z0-9._%+-)
14.	Interval between reboots	Week	Send report every select time interval
15.	Weekday	Sunday	Day of the week to get events log report
16.	Hour	1	Hour of the day to get events log report

7 Network

7.1 Mobile

7.1.1 General

7.1.1.1 Mobile configuration

Here you can configure mobile settings which are used when connecting to your local 3G/LTE network.

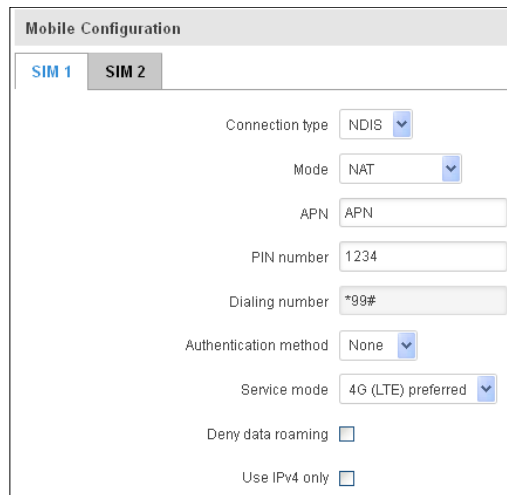

The screenshot shows the 'Mobile Configuration' window for 'SIM 2'. The settings are as follows:

- Connection type: NDIS
- Mode: NAT
- APN: APN
- PIN number: 1234
- Dialing number: *99#
- Authentication method: None
- Service mode: 4G (LTE) preferred
- Deny data roaming:
- Use IPv4 only:

	Field Name	Sample value	Explanation
1.	Connection type	PPP / NDIS	PPP mode uses dialling number to establish data connection. NDIS mode (default) does not use dialling and PPP protocol to establish data connection it is usually faster than PPP mode.
2.	Mode	NAT / Passthrough / Use bridge	NAT mode enables network address translation on router. Bridge mode bridges LTE data connection with LAN. In this mode the router does not have internet connection as ISP provides IP directly to end device (PC, tablet or smart phone). Using Bridge mode will disable most of the router capabilities and you can access your router's settings only by using static IP address on your end device. Passthrough mode is similar with bridge mode except that in passthrough mode router does have internet connection.
3.	APN	"APN"	Access Point Name (APN) is a configurable network identifier used by a mobile device when connecting to a GSM carrier.
4.	PIN number	"1234" or any number that falls between 0000 and 9999	A personal identification number is a secret numeric password shared between a user and a system that can be used to authenticate the user to the system.
5.	Dialing number	*99***1#	Dialling number is used to establish a mobile PPP (Point-to-Point-Protocol) connection.
6.	Authentication method	CHAP, PAP or none	Authentication method, which your carrier uses to authenticate new connections. (This selection is unavailable on the alternate model)
7.	Username	"username"	Your username that you would use to connect to your carriers network. This field becomes available when you select an authentication method (i.e. authentication method is not "none"). These fields are always enabled on the alternate model.
8.	Password	"password"	Your password that you would use to connect to your carriers network. This field becomes available when you select an authentication method (i.e. authentication method is not "none"). These fields are always enabled on the alternate model.

9.	Service mode	2G only, 2G preferred, 3G only, 3G preferred, 4G (LTE) only, 4G (LTE) preferred or automatic.	Your network preference. If your local mobile network supports 2G, 3G and 4G (LTE) you can specify to which network you wish to connect. E.g.: if you choose 2G, the router will connect to a 2G network, so long as it is available, otherwise it will connect to a network that provides better connectivity. If you select auto, then the router will connect to the network that provides better connectivity.
10.	Deny data roaming	Enable/Disable	If enabled this function prevents the device from establishing mobile data connection while not in home network.
11.	Use IPv4 only	Enable / Disable	If enabled this function makes the device to use only IPv4 settings when connecting to operator.

Warning: If an invalid PIN number was entered (i.e. the entered PIN does not match the one that was used to protect the SIM card), your SIM card will get blocked. To avoid such mishaps it is highly advised to use an unprotected SIM. If you happen to insert a protected SIM and the PIN number is incorrect, your card won't get blocked immediately, although after a couple of reboots OR configuration saves it will.

7.1.1.1.1 Passthrough mode

Mode: Passthrough

APN: bangapro

PIN number: 1525

Dialing number: *99#

Authentication method: None

Service mode: Automatic

Deny data roaming:

Use IPv4 only:

DHCP mode: Static

MAC Address:

Lease time: 12 Hours

Using Passthrough Mode will disable most of the router capabilities!

DHCP mode: Static

Enter your computer MAC address (xx:xx:xx:xx:xx:xx) to MAC Address field and select Lease time (expire time for lease addresses). Device, which MAC address will be entered, will get IP from GSM operator. Other connected devices to the router LAN will get IP from router DHCP server, but these devices will not have internet access.

DHCP mode: Dynamic

Using Dynamic mode, device will get IP from GSM operator, which connect to the router firstly. Using Passthrough in dynamic mode, the DHCP in LAN will be disabled.

DHCP mode: No DHCP

Using no DHCP mode, IP (also subnet, gateway and DNS) from GSM operator should be entered in device, which is connected to the router LAN, manually. Using Passthrough in no DHCP mode, the DHCP in LAN will be disabled.

7.1.1.2 Mobile Data On Demand

Mobile Data On Demand

Enable

No data timeout (sec)

	Field name	Possible values	Explanation
1.	Enable	Enable/Disable	Mobile Data On Demand function enables you to keep mobile data connection on only when it's in use
2.	No data timeout(sec)	1-99999999	A mobile data connection will be terminated if no data is transferred during the timeout period

7.1.1.3 Force LTE network

Force LTE network

Enable

Reregister

Interval (sec)

	Field name	Possible values	Explanation
1.	Enable	Enable/Disable	Enable/disable try to connect to LTE network every x seconds (used only if service mode is set to 4G (LTE) preferred)
2.	Reregister	Enable/Disable	If this enabled, modem will be reregister before try to connect to LTE network
3.	Interval (sec)	180 - 3600	Time in seconds between tries to connect to LTE network. Range [180-3600]

7.1.2 SIM Management

General

SIM Management

Network Operators

Mobile Data Limit

SIM Idle Protection

SIM Switching

Primary Card

Primary SIM card SIM 1 ▼

SIM Switching

Enable automatic switching

Check interval

SIM1 To SIM2

SIM2 To SIM1

On weak signal

On data limit

On sms limit

On roaming

No network

On network denied

On data connection fail

	Field name	Possible values	Explanation
1.	Primary SIM card	SIM 1 / SIM 2	SIM card that will be used in the system as a primary SIM card
2.	Enable automatic switching	Enable/Disable	Automatically switch between primary and secondary SIM cards based on the various rules and criteria defined below
3.	Check interval	1-3600	Check interval in seconds
4.	On weak signal	Enable/Disable	Perform a SIM card switch when a signal's strength drops below a certain threshold
5.	On data limit*	Enable/Disable	Perform a SIM card switch when mobile data limit for your current SIM card is exceeded
6.	On SMS limit*	Enable/Disable	Perform a SIM card switch when SMS limit for your current SIM card is exceeded
7.	On roaming	Enable/Disable	Perform a SIM card switch when roaming is detected
8.	No network	Enable/Disable	Perform a SIM card switch when no operator is detected
9.	On network denied	Enable/Disable	Perform a SIM card switch when network is denied
10.	On data connection fail	Enable/Disable	Perform a SIM card switch when data connection fails

* Your carrier's data usage accounting may differ. Teltonika is not liable should any accounting discrepancies occur.

7.1.3 Network Operators

7.1.3.1 Network Operators

This function lets you Scan, Select and enter manual Network Operator to which router should connect. Function will provide great utility when router is in Roaming conditions. Operator is selected only for the active SIM card. In order to specify operator for the other SIM card it must first be selected as primary SIM in “SIM Management”.

The screenshot shows the 'Network Operators' configuration interface. It features a header with 'Network Operators' and 'Operators List' tabs. The main content area is titled 'Network Operators' and includes a 'Current SIM' section with fields for 'SIM card in use' (SIM 1) and 'Current operator' (OMNITEL LT). Below this is a 'Scan For Network Operators' section with 'SIM 1' and 'SIM 2' tabs. At the bottom, there is a 'Scan for operators' button, a 'Connection mode' dropdown menu set to 'Auto', and a 'Select' button.

	Field Name	Sample Value	Explanation
1.	SIM card in use	SIM 1 / SIM 2	Shows current SIM card's in use
2.	Current operator	OMNITEL LT	Operator's name of the connected GSM network

Note: after clicking Scan for operators' button- You will lose current mobile connection! For changing network operator status have to be available. There is manual connection to network operator, you have to fill numeric name, and it's have to be available.

7.1.3.2 Operator List

This function lets to create white list/black list based on operator's code.

	Field name	Possible values	Explanation
1.	Enable	Enable/Disable	Enable/disable operators blocking
2.	Mode	White list/Black list	White list - allows every operator on the list and blocks everything else. Black list – block every operator on the list and allow everything else
3.	Name	Tele2 LT	Operator's name
4.	Operator code	24603	Operator's code

7.1.4 Mobile Data Limit

This function lets you limit maximum amount of data transferred on WAN interface in order to minimize unwanted traffic costs.

7.1.4.1 Data Connection Limit Configuration

	Field Name	Sample value	Explanation
1.	Enable data connection limit	Enable/Disable	Disables mobile data when a limit for current period is reached
2.	Data limit* (MB)	200	Disable mobile data after limit value in MB is reached
3.	Period	Month/Week/Day	Period for which mobile data limiting should apply
4.	Start day/ Start hour	1	A starting time for mobile data limiting period

* Your carrier's data usage accounting may differ. Teltonika is not liable should any accounting discrepancies occur.

7.1.4.2 SMS Warning Configuration

SMS Warning Configuration

Enable SMS warning

Data limit* (MB)

Period

Start day

Phone number

	Field Name	Sample value	Explanation
1.	Enable SMS warning	Enable/Disable	Enables sending of warning SMS message when mobile data limit for current period is reached
2.	Data limit* (MB)	300	Send warning SMS message after limit value in MB is reached
3.	Period	Month/Week/Day	Period for which mobile data limiting should apply
4.	Start day/ Start hour	1	A starting time for mobile data limiting period
5.	Phone number	+37012345678	A phone number to send warning SMS message to, e.g. +37012345678

* Your carrier's data usage accounting may differ. Teltonika is not liable should any accounting discrepancies occur.

7.1.5 SIM Idle protection

Some operators block user SIM cards after period of inactivity. This function enables router to periodically switch to secondary SIM card and establish data connection with mobile network in order to prevent SIM card blocking.

7.1.5.1 Settings

SIM Idle Protection Configuration

SIM1 SIM2

Enable

Period

Day

Hour

Minute

Host to ping

Ping package size

Ping requests

	Field Name	Sample value	Explanation
1.	Enable	Enable/Disable	Enables SIM idle protection
2.	Period	Month / Week	Switches between monthly and weekly SIM activation periods
3.	Day	1-31 / Monday - Sunday	Specifies the day for SIM idle protection activation, 1-31 if Period is Month, and Monday – Sunday if period is week.
4.	Hour	1-24	Specifies the hour for SIM idle protection activation
5.	Minute	1-60	Specifies the minute for SIM idle protection activation
6.	Host to ping	8.8.8.8	Specifies IP address or domain name to send data packages to
7.	Ping package size	56	Specifies ping Package size in bytes
8.	Ping requests	2	Specifies requests to be sent

7.1.5.2 Test

Tests the functioning of idle protection with your parameters entered at settings tab.

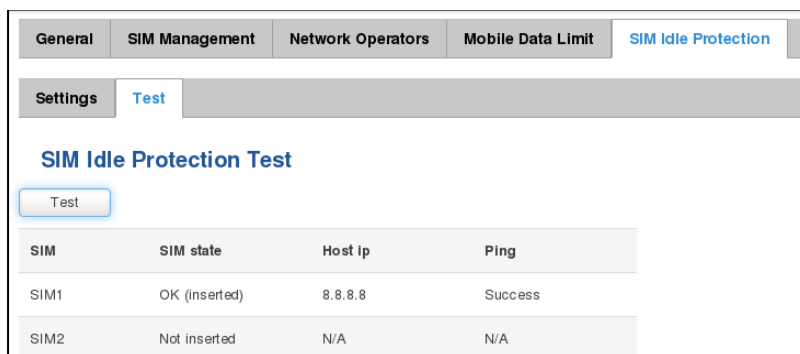

	Field Name	Sample value	Explanation
1.	SIM	SIM1 / SIM2	Displays SIM number
2.	SIM state	OK (inserted)	Displays status of the SIM card
3.	Host IP	8.8.8.8	Displays the IP of the Host
4.	Ping	Success	Displays status of ping attempt

7.2 WAN

7.2.1 Operation Mode

Your WAN configuration determines how the router will be connecting to the internet.

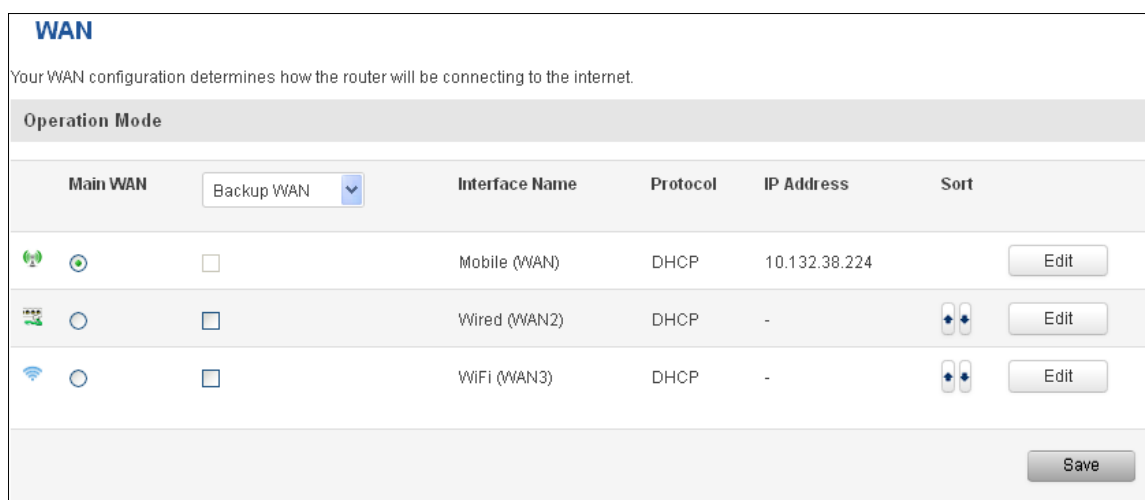

	Type	Explanation
1.	Main WAN	Switches between Mobile, Wired and Wi-Fi interface for main WAN
2.	Backup WAN/Load balancing	Let's user to select one or two interfaces for WAN backup
3.	Interface Name	Displays WAN interface name, and changes interface priority, the interface at the table top has the highest priority
4.	Protocol	Displays protocol used by WAN interface
5.	IP Address	Displays IP address acquired by specific interface
6.	Sort	Sorts table rows and changes interface priority, the highest interface has highest priority

7.2.2 Common configuration

Common configuration allows you to configure your TCP/IP settings for the wan network.

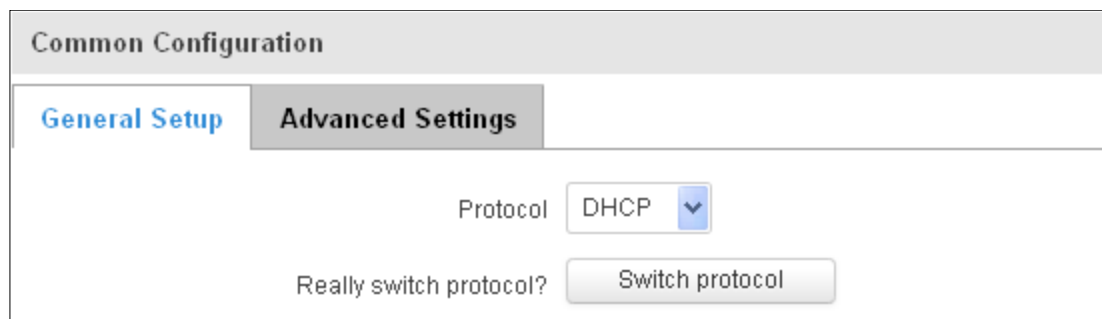

The screenshot shows the 'Common Configuration' window with the 'Advanced Settings' tab selected. The 'Protocol' dropdown menu is set to 'DHCP'. Below it, there is a 'Really switch protocol?' label and a 'Switch protocol' button.

You can switch between the Static, DHCP or PPPoE protocol by selecting the protocol that you want to use and then pressing **Switch Protocol**.

7.2.2.1 General Setup

7.2.2.1.1 Static:

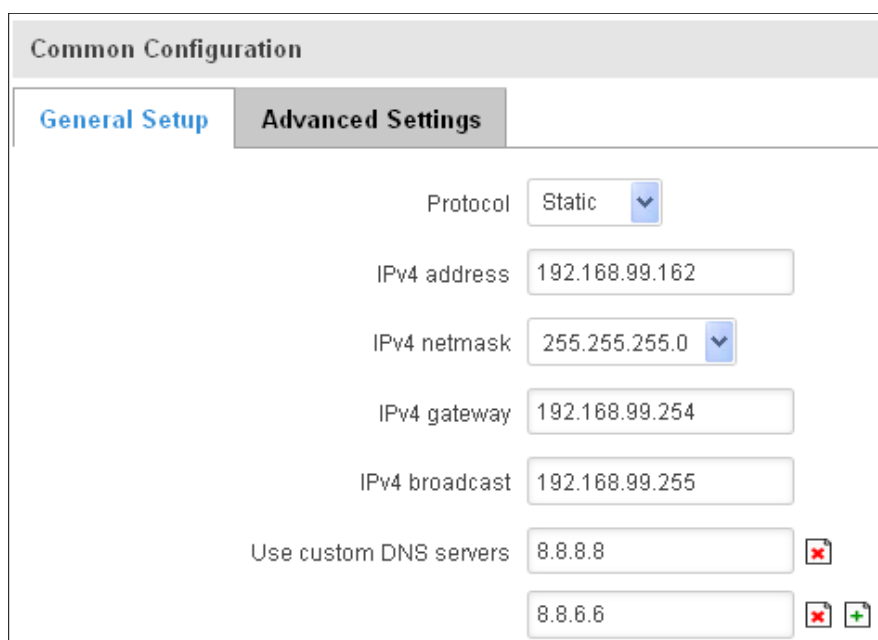

The screenshot shows the 'Common Configuration' window with the 'Advanced Settings' tab selected. The 'Protocol' dropdown menu is set to 'Static'. The following fields are visible: IPv4 address (192.168.99.162), IPv4 netmask (255.255.255.0), IPv4 gateway (192.168.99.254), and IPv4 broadcast (192.168.99.255). Under 'Use custom DNS servers', two entries are shown: 8.8.8.8 and 8.8.6.6, each with a red 'X' icon and a green '+' icon.

This is the configuration setup for when you select the static protocol.

	Filed name	Sample	Explanation
1.	IPv4 address	192.168.99.162	Your routers address on the WAN network
2.	IPv4 netmask	255.255.255.0	A mask used to define how “large” the WAN network is
3.	IPv4 gateway	192.168.99.254	Address where the router will send all the outgoing traffic
4.	IPv4 broadcast	192.168.99.255	Broadcast address (auto generated if not set). It is best to leave this blank unless you know what you are doing.
5.	Use custom DNS servers	8.8.8.8 8.8.6.6	Usually the gateway has some predefined DNS servers. As such the router, when it needs to resolve a hostname (“www.google.com”, “www.cnn.com”, etc..) to an IP address, it will forward all the DNS requests to the gateway. By entering custom DNS servers the router will take care of host name resolution. You can enter multiple DNS servers to provide redundancy in case the one of the server fails.

7.2.2.1.2 DHCP:

Common Configuration

General Setup **Advanced Settings**

Protocol

Hostname to send when requesting DHCP

When you select the DHCP protocol you can use it as is, because most networks will not require any additional advanced configuration.

7.2.2.1.3 PPPoE

This protocol is mainly used by DSL providers:

Common Configuration

General Setup **Advanced Settings**

Protocol

PAP/CHAP username

PAP/CHAP password

Access Concentrator

Service Name

This is the configuration setup for when you select PPPoE protocol.

	Filed name	Sample	Explanation
1.	PAP/CHAP username	test	Your username and password that you would use to connect to your carriers network.
2.	PAP/CHAP password	your_password	A mask used to define how “large” the WAN network is
3.	Access Concentrator	auto	Specifies the name of access concentrator. Leave empty to auto detect.
4.	Service Name	auto	Specifies the name of the service. Leave empty to auto detect.

7.2.2.2 Advanced

These are the advanced settings for each of the protocols, if you are unsure of how to alter these attributes it is highly recommended to leave them to a trained professional:

7.2.2.2.1 Static

Common Configuration

General Setup

Advanced Settings

Disable NAT

Override MAC address

Override MTU

Use gateway metric

	Field name	Sample value	Explanation
1.	Disable NAT	On/Off	Toggle NAT on and off.
2.	Override MAC address	86:48:71:B7:E9:E4	Override MAC address of the WAN interface. If your ISP gives you a static IP address it might also bind it to your computers MAC address (i.e. that IP will only work with your computer). In this field you can enter your computers MAC address and fool the gateway in thinking that it is communicating with your computer.
3.	Override MTU	1500	Maximum Transmission Unit – specifies the largest possible size of a data packet.
4.	Use gateway metric	0	The WAN configuration by default generates a routing table entry. With this field you can alter the metric of that entry.

7.2.2.2.2 DHCP

Common Configuration

General Setup

Advanced Settings

Disable NAT

Use broadcast flag

Use default gateway

Use DNS servers advertised by peer

Use gateway metric

Client ID to send when requesting DHCP

Vendor Class to send when requesting DHCP

Override MAC address

Override MTU

	Field name	Sample value	Explanation
1.	Disable NAT	Enable/Disable	If checked, router will not perform NAT (masquerade) on this interface
2.	Use broadcast flag	Enable/Disable	Required for certain ISPs, e.g. Charter with DOCSIS 3
3.	Use default gateway	Enable/Disable	If unchecked, no default route is configured
4.	Use DNS server advertised by peer	Enable/Disable	If unchecked, the advertised DNS server addresses are ignored
5.	User gateway metric	0	The WAN configuration by default generates a routing table entry With this field you can alter the metric of that entry
6.	Client ID to send when		Specify client ID which will be sent when requesting DHCP

	requesting DHCP		(Dynamic Host Configuration Protocol)
7.	Vendor Class to send when requesting DHCP		Specify vendor class which be sent when requesting DHCP (Dynamic Host Configuration Protocol)
8.	Override MAC address	86:48:71:B7:E9:E4	Override MAC address of the WAN interface. If your ISP gives you a static IP address it might also bind it to your computers MAC address (i.e. that IP will only work with your computer). In this field you can enter your computers MAC address and fool the gateway in thinking that it is communicating with your computer.
9.	Override MTU	1500	Maximum transmission unit – specifies the largest possible size of a data packet.

7.2.2.2.3 PPPoE

Common Configuration

General Setup **Advanced Settings**

Disable NAT

Use default gateway

Use gateway metric

Use DNS servers advertised by peer

LCP echo failure threshold

LCP echo interval

Inactivity timeout

	Field name	Sample value	Explanation
1.	Disable NAT	Enable/Disable	If checked, router will not perform NAT (masquerade) on this interface
2.	Use default gateway	Enable/Disable	If unchecked, no default route is configured
3.	Use gateway metric	0	
4.	Use DNS servers advertised by peer	Enable/Disable	If unchecked, the advertised DNS server addresses are ignored
5.	LCP echo failure threshold	0	Presume peer to be dead after given amount of LCP echo failures, use 0 to ignore failures
6.	LCP echo interval	5	Send LCP echo requests at the given interval in seconds, only effective in conjunction with failure threshold
7.	Inactivity timeout	0	Close inactive connection after the given amount of seconds, use 0 to persist connection

7.2.2.2.4 IP Aliases

IP aliases are a way of defining or reaching a subnet that works in the same space as the regular network.

The screenshot shows the 'Advanced Settings' tab for a network configuration. It contains three input fields: 'IP Address' with the value '192.168.99.161', 'Netmask' with a dropdown menu showing '255.255.255.0', and 'Gateway' with the value '192.168.99.254'. On the left side, there are 'Delete' and 'Add' buttons. At the bottom right, there is a 'Save' button.

As you can see, the configuration is very similar to the static protocol; only in the example a 99th subnet is defined. Now if some device has an IP in the 99 subnet (192.168.99.xxx) and the subnets gateway metric is “higher” and the device is trying to reach the internet it will reroute it’s traffic not to the gateway that is defined in common configurations but through the one that is specified in IP aliases.

The screenshot shows the 'Advanced Settings' tab for a network configuration. It contains two input fields: 'IP Broadcast' and 'DNS Server'. On the left side, there are 'Delete' and 'Add' buttons. At the bottom right, there is a 'Save' button.

You may also optionally define a broadcast address and a custom DNS server.

7.2.2.2.5 Backup WAN configuration

Backup WAN is function that allows you to back up your primary connection in case it goes down. There can be two backup connections selected at the same time, in that case, when primary connection fails, router tries to use backup with higher priority and if that is unavailable or fails too, then router tries the backup with lower priority.

The screenshot shows the 'Backup Configuration' tab. It includes a descriptive text: 'Timing and other parameters will indicate how and when it will be determined that your conventional connection has gone down.' Below this are five settings, each with a dropdown menu: 'Health monitor interval' (10 sec), 'Health monitor ICMP host(s)' (8.8.4.4), 'Health monitor ICMP timeout' (3 sec), 'Attempts before failover' (3), and 'Attempts before recovery' (3).

The majority of the options consist of timing and other important parameters that help determine the health of your primary connection. Regular health checks are constantly performed in the form of ICMP packets (Pings) on your primary connection. When the connections state starts to change (READY->NOT READY and vice versa) a necessary amount of failed or passed health checks has to be reached before the state changes completely. This delay is instituted so as to mitigate “spikes” in connection availability, but it also extends the time before the backup link can be brought up or down.

Field Name	Sample value	Explanation
------------	--------------	-------------

1.	Health monitor Interval	Disable/5/10/20/30/60/120 Seconds	The interval at which health checks are performed
2.	Health monitor ICMP host(s)	Disable/DNS Server(s) /WAN GW/Custom	Where to Ping for a health check. As there is no definitive way to determine when the connection to internet is down for good, you'll have to define a host whose availability that of the internet as a whole.
3.	Health monitor ICMP timeout	1/3/4/5/10 Seconds	How long to wait for an ICMP request to come back. Set a higher value if your connection has high latency or high jitter (latency spikes).
4.	Attempts before failover	1/3/5/10/15/20	How many checks should fail for your WAN connection to be declared DOWN for good.
5.	Attempts before recovery	1/3/5/10/15/20	How many checks should pass for your WAN connection to be declared UP.

7.2.2.3 How do I set up a backup link?

First we must select a main link and choose one or two backup links in WAN section. Then push the "Edit" button and configure your WAN and Backup Wan settings to your liking. Click Save and wait until the settings are applied. Now in the Status -> Network Information -> WAN page there should be a status indication for the backup WAN. If everything is working correctly you should see something like this:



The above picture shows the status for Backup WAN configured on a wired main link. You can now simulate a downed link by simply unplugging your Ethernet WAN cable. When you've done so you should see this:



And, if you plug the cable back in you should, again, see this:



7.3 LAN

This page is used to configure the LAN network, where all your devices and computers that you connect to the router will reside.

7.3.1 Configuration

7.3.1.1 General Setup

The screenshot shows the 'Configuration' page with the 'General Setup' tab selected. The 'Advanced Settings' tab is also visible. The configuration fields are as follows:

Field name	Sample value
IP address	192.168.1.1
IP netmask	255.255.255.0
IP broadcast	

	Field name	Sample value	Explanation
1.	IP address	192.168.1.1	Address that the router uses on the LAN network
2.	IP netmask	255.255.255.0	A mask used to define how large the LAN network is
3.	IP broadcast		IP broadcasts are used by BOOTP and DHCP clients to find and send requests to their respective servers

7.3.1.2 Advanced settings

The screenshot shows the 'Configuration' page with the 'Advanced Settings' tab selected. The configuration fields are as follows:

Field name	Sample value
Accept router advertisements	<input type="checkbox"/>
Override MTU	1500
Use gateway metric	0
Use WAN port as LAN	<input type="checkbox"/>

	Field name	Sample value	Explanation
1.	Accept router advertisements	Enable/Disable	If enabled allows accepting router advertisements (Disabled by default)
2.	Override MTU	1500	MTU (Maximum Transmission Unit) specifies the largest possible size of a data packet
3.	Use gateway metric	0	With this field you can alter the metric of that entry
4.	Use WAN port as LAN	Enable/Disable	Enable/disable WAN port using as LAN port

7.3.2 DHCP Server

The DHCP server is the router side service that can automatically configure the TCP/IP settings of any device that requests such a service. If you connect a device that has been configured to obtain IP address automatically the DHCP server will lease an IP address and the device will be able to fully communicate with the router.

7.3.2.1 General Setup

DHCP Server

General Setup

Advanced Settings

DHCP

Start

Limit

Lease time

	Field Name	Sample value	Explanation
1.	DHCP	Enable / Disable/ DHCP Relay	Manage DHCP server
2.	Start	100	The starting address of the range that the DHCP server can use to give out to devices. E.g.: if your LAN IP is 192.168.2.1 and your subnet mask is 255.255.255.0 that means that in your network a valid IP address has to be in the range of [192.168.2.1 – 192.168.2.254](192.168.2.0 and 192.168.2.255 are special unavailable addresses). If the Start value is set to 100 then the DHCP server will only be able to lease out addresses starting from 192.168.2.100
3.	Limit	155	How many addresses the DHCP server gets to lease out. Continuing on the above example: if the start address is 192.168.2.100 then the end address will be 192.168.2.254 (100 + 155 – 1 = 254).
4.	Lease time	12	How long can a leased IP be considered valid. An IP address after the specified amount of time will expire and the device that leased it out will have to request for a new one. Select Hour or Minute (minimum 2min).

7.3.2.2 Advanced settings

You can also define some advanced options that specify how the DHCP server will operate on your LAN network.

	Field Name	Sample Value	Explanation
1.	Dynamic DHCP	Checked/Unchecked	Dynamically allocate client addresses, if set to 0 only clients present in the <code>ethers</code> files are served
2.	Force	Checked/Unchecked	Forces DHCP serving even if another DHCP server is detected on the same network segment.
3.	IP netmask		You can override your LAN netmask here to make the DHCP server think it's serving a larger or a smaller network than it actually is.
4.	DHCP Options		Additional options to be added for this DHCP server. For example with '26,1470' or 'option:mtu, 1470' you can assign an MTU per DHCP. Your client must accept MTU by DHCP for this to work.

7.3.2.3 Static Leases

This page is used to configure static IP leases.

	Field Name	Sample Value	Explanation
1.	Hostname	Printer	Name which will be linked with IP address.
2.	MAC address	10:a5:d0:70:9c:72 (192.168.1.104)	Device MAC address
3.	IP address	192.168.1.104	Device IP address

7.3.2.4 IP Aliases

7.3.2.4.1 General Setup

IP aliases are the way of defining or reaching a subnet that works in the same space as the regular network.

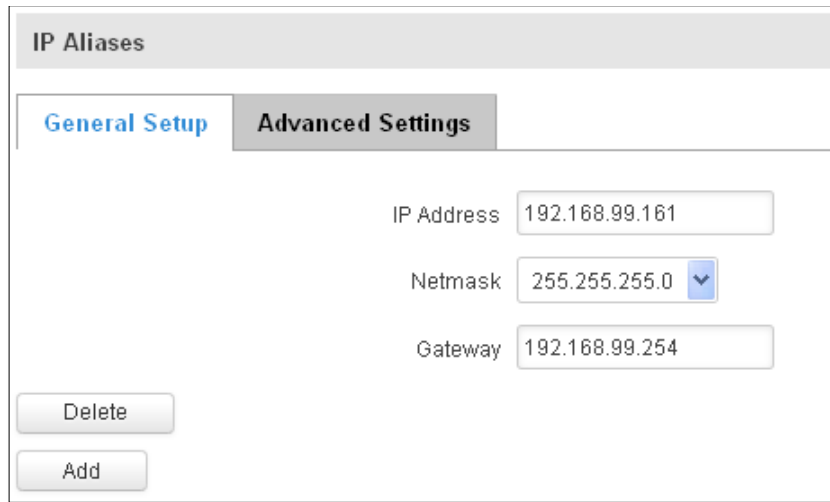

The screenshot shows the 'IP Aliases' configuration window with the 'Advanced Settings' tab selected. The 'General Setup' tab is also visible. The 'Advanced Settings' section contains three input fields: 'IP Address' with the value '192.168.99.161', 'Netmask' with a dropdown menu showing '255.255.255.0', and 'Gateway' with the value '192.168.99.254'. At the bottom left, there are two buttons: 'Delete' and 'Add'.

7.3.2.4.2 Advanced Settings

You may also optionally define a broadcast address and a custom DNS server.

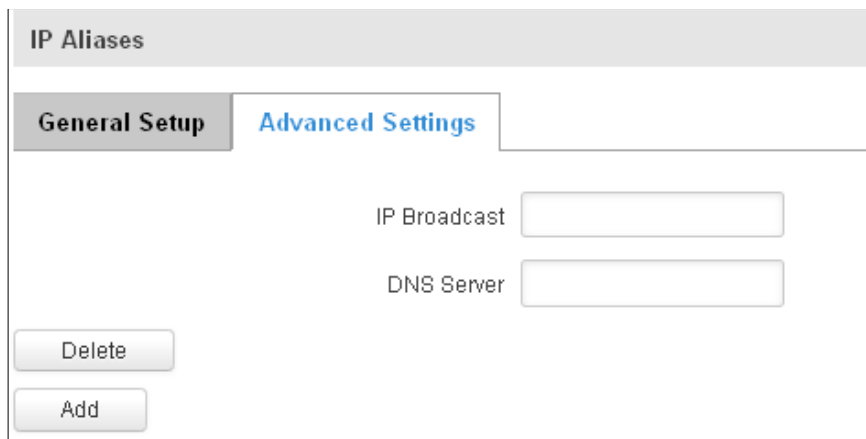

The screenshot shows the 'IP Aliases' configuration window with the 'General Setup' tab selected. The 'Advanced Settings' tab is also visible. The 'General Setup' section contains two input fields: 'IP Broadcast' and 'DNS Server'. At the bottom left, there are two buttons: 'Delete' and 'Add'.

7.4 Wireless

On this page you can configure your wireless settings. Depending on whether your WAN mode is set to Wi-Fi or not, the page will display either the options for configuring an **Access Point** or options for configuring a **connection** to some local access point.

Access Point:

Wireless Access Point

Here you can configure your wireless settings like radio frequency, mode, encryption etc...

Device Configuration

General Setup **Advanced Settings**

Enable wireless

Channel

Interface Configuration

General Setup **Wireless Security** **MAC Filter** **Advanced Settings**

SSID

Hide SSID

WRP100 Configuration

Connect WRP100 automatically

Here you can see the Overview of the wireless configuration. It is divided into two main sections – device and interface. One is dedicated to configuring hardware parameters other – software.

Here you can toggle the availability of the wireless radio and the physical channel frequency.

Important note: As seen in the picture you should always **Save** before toggling the radio on and off.

SSID – Your wireless networks identification string. This is the name of your Wi-Fi network. When other Wi-Fi capable computers or devices scan the area for Wi-Fi networks they will see your network with this name.

Hide SSID – Will render your SSID hidden from other devices that try to scan the area.

Connect to WRP100 automatically – let Teltonika WRP100 wireless repeater connect to this router automatically.

7.4.1.1 Device

7.4.1.1.1 Advanced Settings

General Setup **Advanced Settings**

Mode

Country code

Transmit power

Fragmentation threshold

RTS/CTS threshold

Here you can configure more advanced parameters:

	Field name	Sample value	Explanation
1.	Mode	Auto, b, g, g+n	Different modes provide different throughput and security options.
2.	Country Code	Any ISO/IEC 3166 alpha2 country code	Selecting this will help the wireless radio configure its internal parameters to meet your countries wireless regulations.
3.	Transmit power	20%/40%/60%/80%/100%	Select Wi-Fi signal power
4.	Fragmentation threshold	2346	The smallest packet size that can be fragmented and transmitted by multiple frames. In areas where interference is a problem, setting a lower fragment threshold might help reduce the probability of unsuccessful packet transfers, thus increasing speed.
5.	RTS/CTS Threshold	2346	Request to send threshold. It can help resolve problems arising when several access points are in the same area, contending.

7.4.1.2 Interface

7.4.1.2.1 Security

Encryption – there are many modes of encryption, a distinctive class is pointed out below.

First select an encryption method: TKIP, CCMP, TKIP&CCMP and auto. Note: Some authentication methods won't support TKIP (and TKIP&CCMP) encryption. After you've selected your encryption method, you should enter your pass phrase, which must be at least 8 characters long.

7.4.1.2.2 MAC-Filter

Filter – you can define a rule for what to do with the MAC list you've defined. You can either allow only the listed MACs or allow ALL, but forbid only the listed ones.

7.4.1.2.3 Advanced settings

Separate clients – prevents Wi-Fi clients from communicating with each other on the same subnet.

Increase TTL packet size – increase TTL packet size for incoming packets.

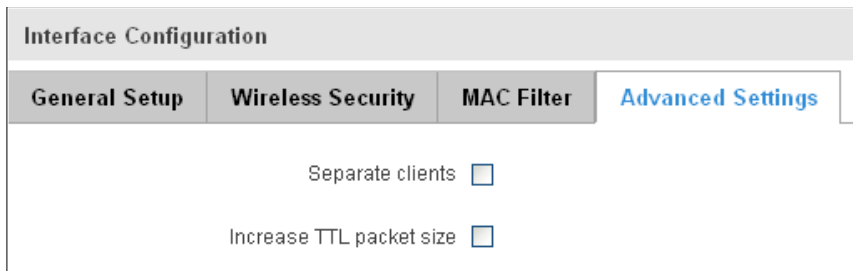

7.4.1.3 Client

RUT9xx can work as a Wi-Fi client. Client mode is nearly identical to AP, except for the fact that most for the options are dictated by the wireless access point that the router is connecting to. Changing them can result in an interrupted connection to an AP.

In addition to standard options you can also click the **Scan** button to rescan the surrounding area and attempt to connect to a new wireless access point.

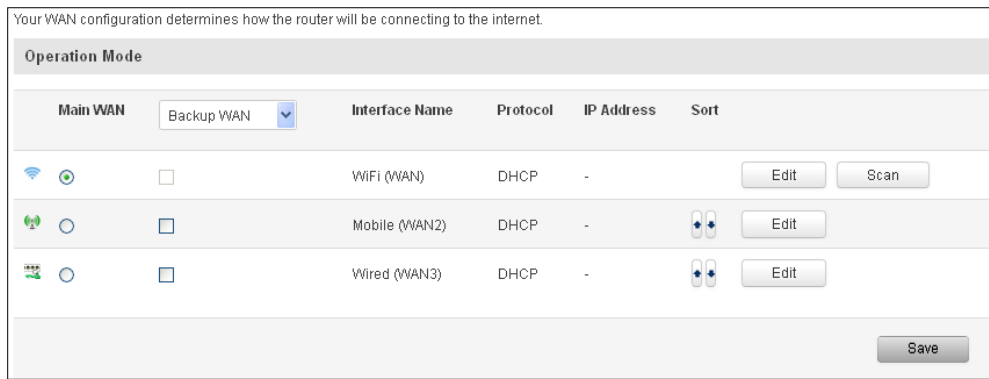

7.5 VLAN

On this page you can configure your Virtual LAN settings, either Port based or Tag based.

7.5.1 VLAN Networks

7.5.1.1 VLAN Functionality



	Field Name	Sample Value	Explanation
1.	VLAN mode	Disabled / Port based / Tag based	Lets user to choose the VLAN mode or disable VLAN functionality.

7.5.1.2 VLAN Network List

If VLAN mode – Port based:

VLAN Networks List					
VLAN ID	LAN ports			Wireless access points	LAN
	1	2	3	Teltonika_Router	
<input type="text" value="1"/>	<input type="button" value="On"/> ▾	<input type="button" value="On"/> ▾	<input type="button" value="On"/> ▾	<input type="checkbox"/>	<input type="button" value="None"/> ▾ <input type="button" value="Delete"/>
<input type="button" value="Add"/>					

	Field Name	Sample Value	Explanation
1.	VLAN ID	1	VLAN Identification number, allowed in range (1-4094)
2.	LAN ports 1 / 2 / 3	on	Switches each LAN port between ON, OFF or tagged state.
3.	Wireless access points	Enabled / Disabled	Assign selected access point(s) to selected LAN.
4.	LAN	None	Select to which LAN to assign selected LAN ports and wireless access points.

If VLAN mode – Tag based:

VLAN Networks List		
VLAN ID	Wireless access points	
	Teltonika_Router	LAN
<input type="text" value="2"/>	<input type="checkbox"/>	<input type="button" value="None"/> ▾ <input type="button" value="Delete"/>
<input type="button" value="Add"/>		

	Field Name	Sample Value	Explanation
1.	VLAN ID	2	VLAN Identification number, allowed in range (1-4094)
3.	Wireless access points	Enabled / Disabled	Assign selected access point(s) to selected LAN.
4.	LAN	None	Select to which LAN to wireless access point(s).

7.5.2 LAN Networks

In this page you can create extra LAN networks, and assign them with LAN Ports and wireless access points. You can get extra information on how to configure any of your LAN's settings in section – 7.3 LAN

LAN

LAN Networks List

LAN name	Interface name	
Lan	eth0 tap0	<input type="button" value="Edit"/>

LAN name:

	Field Name	Sample Value	Explanation
1.	LAN name	Lan	Specifies new LAN name
2.	Interface name	eth0 tap0	Specifies LAN interface name

7.6 Firewall

In this section we will look over the various firewall features that come with RUT9.

7.6.1 General Settings

The routers firewall is a standard Linux iptables package, which uses routing chains and policies to facilitate control over inbound and outbound traffic.

General Settings
Port Forwarding
Traffic Rules
Custom Rules
DDOS Prevention

Firewall

General settings allows you to set up default firewall policy.

General Settings

Drop invalid packets

Input

Output

Forward

	Field Name	Sample value	Explanation
1.	Drop Invalid packets	Checked/Unchecked	A "Drop" action is performed on a packet that is determined to be invalid

2.	Input	Reject/Drop/Accept	DEFAULT* action that is to be performed for packets that pass through the Input chain.
3.	Output	Reject/Drop/Accept	DEFAULT* action that is to be performed for packets that pass through the Output chain.
4.	Forward	Reject/Drop/Accept	DEFAULT* action that is to be performed for packets that pass through the Forward chain.

*DEFAULT: When a packet goes through a firewall chain it is matched against all the rules for that specific chain. If no rule matches said packet, an according Action (either Drop or Reject or Accept) is performed.

Accept – Packet gets to continue down the next chain.

Drop – Packet is stopped and deleted.

Reject – Packet is stopped, deleted and, differently from Drop, an ICMP packet containing a message of rejection is sent to the **source** of the dropped packet.

7.6.2 DMZ

DMZ Configuration

Enable

DMZ host IP address

By enabling DMZ for a specific internal host (for e.g.: your computer), you will expose that host and its services to the routers WAN network (i.e. - internet).

7.6.3 Port Forwarding

Here you can define your own port forwarding rules.

Firewall - Port Forwarding

Port forwarding allows remote computers on the Internet to connect to a specific computer or service within the private LAN.

Port Forwarding Rules

Name	Protocol	Source	Via	Destination	Enable	Sort	
Enable_SSH_WAN_PASSTHROUGH	TCP	From any host in wan	To any router IP at port 22	Forward to IP 127.0.0.1, port 22 in lan	<input type="checkbox"/>	↑ ↓	Edit Delete
Enable_HTTP_WAN_PASSTHROUGH	TCP	From any host in wan	To any router IP at port 80	Forward to IP 127.0.0.1, port 80 in lan	<input type="checkbox"/>	↑ ↓	Edit Delete
Enable_HTTPS_WAN_PASSTHROUGH	TCP	From any host in wan	To any router IP at port 443	Forward to IP 127.0.0.1, port 443 in lan	<input type="checkbox"/>	↑ ↓	Edit Delete
Enable_CLI_WAN_PASSTHROUGH	TCP	From any host in wan	To any router IP at port 4200	Forward to IP 127.0.0.1, port 4200 in lan	<input type="checkbox"/>	↑ ↓	Edit Delete

New Port Forward Rule

Name	Protocol	External port (s)	Internal IP	Internal port (s)	
<input type="text" value="Enable_Test_Rule"/>	TCP+UDP	<input type="text" value="12345"/>	192.168.1.109	<input type="text" value="12345"/>	<input type="button" value="Add"/>

You can use port forwarding to set up servers and services on local LAN machines. The above picture shows how you can set up a rule that would allow a website that is being hosted on 192.168.1.109, to be reached from the outside by entering `http://routersExternallp:12345/`.

	Field Name	Sample value	Explanation
1.	Name	Enable_SSH_WAN_PASSTHROUGH	Name of the rule. Used purely to make it easier to manage rules.
2.	Protocol	TCP/UDP/TCP+UDP/Other	Type of protocol of incoming packet.
3.	External Port	1-65535	From this port on the WAN network the traffic will be forwarded.
4.	Internal IP address	IP address of some computer on your LAN	The IP address of the internal machine that hosts some service that we want to access from the outside.
5.	Internal port	1-65535	To that port on the internal machine the rule will redirect the traffic.





When you click **edit** you can fine tune a rule to near perfection, if you should desire that.

This page allows you to change advanced properties of the port forwarding entry. Although, in most cases there is no need to modify those settings.

Enable

Name

Protocol

Source zone lan: lan:  vpn: openvpn:  gre tunnel:  wan: wan:  ppp: 





Source MAC address

Source IP address

Source port

External IP address

External port

Internal zone lan: lan:  vpn: openvpn:  gre tunnel:  wan: wan:  ppp: 

Internal IP address

Internal port

Enable NAT loopback

Extra arguments

	Field Name	Sample value	Explanation
1.	Name	ENABLE_SSH_WAN_PASSTHROUGH	Name of the rule. Used purely to make it easier to manage rules.
2.	Protocol	TCP/UDP/TCP+ UDP/ICMP/Custom	You may specify multiple by selecting (custom) and then entering protocols separated by space
3.	Source zone	LAN/VPN/WAN	Match incoming traffic from this zone only
4.	Source MAC address	any	Match incoming traffic from these MACs only
5.	Source IP address	any	Match incoming traffic from this IP or range only
7.	Source port	any	Match incoming traffic originating from the given source port or port range on the client host only
8.	External IP address	any	Match incoming traffic directed at the given IP address only
9.	External port	22	Match incoming traffic directed at the given destination port or port range on this host only
10.	Internal zone	LAN/VPN/WAN	Redirect matched incoming traffic to the specified internal zone
11.	Internal IP address	127.0.0.1	Redirect matched incoming traffic to the specified internal host
12.	Internal port	any	Redirect matched incoming traffic to the given port on the internal host
13.	Enable NAT loopback	Enable/Disable	NAT loopback enables your local network (i.e. behind your router/modem) to connect to a forward-facing IP address (such as 208.112.93.73) of a machine that it also on your local network
14.	Extra arguments		Passes additional arguments to iptables. Use with care!

7.6.4 Traffic Rules

The traffic rule page contains a more generalized rule definition. With it you can block or open ports, alter how traffic is forwarded between LAN and WAN and many more things.

Name	Protocol	Source	Destination	Action	Enable	Sort
Allow-DHCP-Relay	UDP	From any host in wan	To any router IP at port 67 on this device	Accept input	<input type="checkbox"/>	↑ ↓ Edit Delete
Allow-DHCP-Renew	UDP	From any host in wan	To any router IP at port 68 on this device	Accept input	<input checked="" type="checkbox"/>	↑ ↓ Edit Delete
Allow-Ping	ICMP with type echo-request	From any host in wan	To any router IP on this device	Accept input	<input checked="" type="checkbox"/>	↑ ↓ Edit Delete

	Field Name	Explanation
1.	Name	Name of the rule. Used for easier rules management purpose only
2.	Protocol	Protocol type of incoming or outgoing packet
3.	Source	Match incoming traffic from this IP or range only
4.	Destination	Redirect matched traffic to the given IP address and destination port
5.	Action	Action to be taken for the packet if it matches the rule
6.	Enable	Self-explanatory. Uncheck to make the rule inactive. The rule will not be deleted, but it also will not be loaded into the firewall.
7.	Sort	When a packet arrives, it gets checked for a matching rule. If there are several rules that match the rule, the first one is applied i.e. the order of the rule list impacts how your firewall operates, therefore you are given the ability to sort your list as you wish.

You can configure firewall rule by clicking **edit** button.

This page allows you to change advanced properties of the traffic rule entry, such as matched source and destination hosts.

Enable

Name

Restrict to address family

Protocol

Match ICMP type

Source zone Any zone
 lan: lan:
 vpn: openvpn: gre tunnel:
 wan: wan: ppp:

Source MAC address

Source address

Source port

Destination zone Device (input)
 Any zone (forward)
 lan: lan:
 vpn: openvpn: gre tunnel:
 wan: wan: ppp:

Destination address

Destination port

Action

Extra arguments

	Field Name	Sample value	Explanation
1.	Name	"Allow-DHCP-Relay"	Used to make rule management easier
2.	Restrict to address family	IPv4 and IPV6	Match traffic from selected address family only
3.	Protocol	TCP/UDP/Any/ICMP/Custom	Protocol of the packet that is being matched against traffic rules.
4.	Match ICMP type	any	Match traffic with selected ICMP type only
5.	Source zone	any zone/LAN/VPN/WAN	Match incoming traffic from this zone only
6.	Source MAC address	any	Match incoming traffic from these MACs only
7.	Source address	any	Match incoming traffic from this IP or range only
8.	Source port	any	Match incoming traffic originating from the given source port or port range on the client host only
9.	Destination zone	Device/Any zone/LAN/VPN/WAN	Match forwarded traffic to the given destination zone only
10.	Destination address	any	Match forwarded traffic to the given destination IP address or IP range only
11.	Destination port	67	Match forwarded traffic to the given destination port or port range only
12.	Action	Drop/Accept/Reject + chain + additional rules	Action to be taken on the packet if it matches the rule. You can also define additional options like limiting packet volume, and defining to which chain the rule belongs

7.6.4.1 Open Ports On the Router

Open Ports On Router

Name	Protocol	External port	
<input type="text" value="Open_Port_rule"/>	TCP <input type="button" value="v"/>	<input type="text" value="22"/>	<input type="button" value="Add"/>

	Field Name	Sample value	Explanation
1.	Name	Open_Port_rule	Used to make rule management easier
2.	Protocol	TCP/UDP/Any/ICMP/Custom	Protocol of the packet that is being matched against traffic rules.
3.	External port	1-65535	Match incoming traffic directed at the given destination port or port range on this host.

7.6.4.2 New Forward Rule

New Forward Rule

Name	Source	Destination	
<input type="text" value="Forward rule new"/>	LAN <input type="button" value="v"/>	WAN <input type="button" value="v"/>	<input type="button" value="Add"/>

	Field Name	Sample value	Explanation
1.	Name	Forward rule new	Used to make rule management easier
2.	Source	LAN/VPN/WAN	Match incoming traffic from selected address family only
3.	Protocol	TCP/UDP/Any/ICMP/Custom	Protocol of the packet that is being matched against traffic rules.

7.6.4.3 Source NAT

Source NAT is a specific form of masquerading which allows fine grained control over the source IP used for outgoing traffic, for example to map multiple WAN addresses to internal subnets.

Source NAT

Source NAT is a specific form of masquerading which allows fine grained control over the source IP used for outgoing traffic, for example to map multiple WAN addresses to internal subnets.

Name	Protocol	Source	Destination	SNAT	Enable	
SNAT	TCP+UDP	From any host in lan	To any host, port 22 in wan	Rewrite to source IP 10.101.1.10, port 22	<input checked="" type="checkbox"/>	<input type="button" value="Edit"/> <input type="button" value="Delete"/>

New Source NAT

Name	Source	Destination	Source IP	Source port	
<input type="text" value="New SNAT rule"/>	LAN <input type="button" value="v"/>	WAN <input type="button" value="v"/>	<input type="text"/>	Do not rewrite	<input type="button" value="Add"/>

	Field Name	Sample value	Explanation
1.	Name	SNAT	Used to make rule management easier

2.	Protocol	TCP/UDP/Any/ICMP/Custom	Protocol of the packet that is being matched against traffic rules.
3.	Source	LAN/VPN/WAN	Match incoming traffic from selected address family only
4.	Destination	LAN/VPN/WAN	Forward incoming traffic to selected address family only
5.	SNAT	Rewrite to source IP 10.101.1.10	SNAT (Source Network Address Translation) rewrite packet's source IP address and port
6.	Enable	Enable/Disable	Make a rule active/inactive

You can configure firewall source NAT rule, by clicking **edit** button.

This page allows you to change advanced properties of the traffic rule entry, such as matched source and destination hosts.

Enable

Name

Protocol

Source zone lan: lan: vpn: openvpn: gre tunnel: wan: wan: ppp:

Source MAC address

Source IP address

Source port

Destination zone lan: lan: vpn: openvpn: gre tunnel: wan: wan: ppp:

Destination IP address

Destination port

SNAT IP address

SNAT port

Extra arguments

	Field Name	Sample value	Explanation
1.	Name	SNAT	Used to make rule management easier
2.	Protocol	TCP/UDP/Any/ICMP/Custom	Protocol of the packet that is being matched against traffic rules.
3.	Source zone	LAN/VPN/WAN	Match incoming traffic from this zone only
4.	Source MAC address	any	Match incoming traffic from these MACs only
5.	Source address	any	Match incoming traffic from this IP or range only
6.	Source port	any	Match incoming traffic originating from the given source port or port range on the client host only
7.	Destination zone	LAN/VPN/WAN	Match forwarded traffic to the given destination zone only
8.	Destination IP address	Select from the list	Match forwarded traffic to the given destination IP address or IP range only
9.	Destination port	any	Match forwarded traffic to the given destination port or port range only

10.	SNAT IP address	"10.101.1.10"	Rewrite matched traffic to the given IP address
11.	SNAT port	"22"	Rewrite matched traffic to the given source port. May be left empty to only rewrite the IP address'
12.	Extra arguments		Passes additional arguments to iptables. Use with care!

7.6.5 Custom Rules

Here you have the ultimate freedom in defining your rules – you can enter them straight into the iptables program. Just type them out into the text field and it will get executed as a Linux shell script. If you are unsure of how to use iptables, check out the internet for manuals, examples and explanations.

General Settings | **Port Forwarding** | **Traffic Rules** | **Custom Rules** | **DDOS Prevention** | **Port Scan Prevention**

Firewall - Custom Rules

Custom rules allow you to execute arbitrary iptables commands which are not otherwise covered by the firewall framework. The commands are executed after each firewall restart, right after the default ruleset has been loaded.

```
# This file is interpreted as shell script.
# Put your custom iptables rules here, they will
# be executed with each firewall (re-)start.

# Internal uci firewall chains are flushed and recreated on reload, so
# put custom rules into the root chains e.g. INPUT or FORWARD or into the
# special user chains, e.g. input_wan_rule or postrouting_lan_rule.
```

Reset | Save

7.6.6 DDOS Prevention

7.6.6.1 SYN Flood Protection

SYN Flood Protection allows you to protect from attack that exploits part of the normal TCP three-way handshake to consume resources on the targeted server and render it unresponsive. Essentially, with SYN flood DDoS, the offender sends TCP connection requests faster than the targeted machine can process them, causing network saturation.

General Settings | **Port Forwarding** | **Traffic Rules** | **Custom Rules** | **DDOS Prevention** | **Port Scan Prevention**

DDOS Prevention

SYN Flood Protection

Enable SYN flood protection

SYN flood rate

SYN flood burst

TCP SYN cookies

	Field Name	Sample value	Explanation
1.	Enable SYN flood protection	Enable/Disable	Makes router more resistant to SYN flood attacks.
2.	SYN flood rate	"25"	Set rate limit (packets/second) for SYN packets above which the traffic is considered a flood.
3.	SYN flood burst	"50"	Set burst limit for SYN packets above which the traffic is considered a flood if it exceeds the allowed rate.
4.	TCP SYN cookies	Enable/Disable	Enable the use of SYN cookies (particular choices of initial TCP sequence numbers by TCP servers).

7.6.6.2 Remote ICMP requests

Attackers are using ICMP echo request packets directed to IP broadcast addresses from remote locations to generate denial-of-service attacks.

Remote ICMP requests

Enable ICMP requests

Enable ICMP limit

Limit period Second ▾

Limit

Limit burst

	Field Name	Sample value	Explanation
1.	Enable ICMP requests	Enable/Disable	Blocks remote ICMP echo-request type
2.	Enable ICMP limit	Enable/Disable	Enable ICMP echo-request limit in selected period
3.	Limit period	Second/Minute/Hour/Day	Select in what period limit ICMP echo-request
4.	Limit	"10"	Maximum ICMP echo-request during the period
5.	Limit burst	"5"	Indicating the maximum burst before the above limit kicks in.

7.6.6.3 SSH Attack Prevention

Prevent SSH (Allows a user to run commands on a machine's command prompt without them being physically present near the machine.) attacks by limiting connections in defined period.

SSH Attack Prevention

Enable SSH limit

Limit period Second ▾

Limit

Limit burst

	Field Name	Sample value	Explanation
--	------------	--------------	-------------

1.	Enable SSH limit	Enable/Disable	Enable SSH connections limit in selected period
2.	Limit period	Second/Minute/Hour/Day	Select in what period limit SSH connections
3.	Limit	"10"	Maximum SSH connections during the period
4.	Limit burst	"5"	Indicating the maximum burst before the above limit kicks in.

7.6.6.4 HTTP Attack Prevention

HTTP attack sends a complete, legitimate HTTP header, which includes a 'Content-Length' field to specify the size of the message body to follow. However, the attacker then proceeds to send the actual message body at an extremely slow rate (e.g. 1 byte/110 seconds). Due to the entire message being correct and complete, the target server will attempt to obey the 'Content-Length' field in the header, and wait for the entire body of the message to be transmitted, hence slowing it down.

HTTP Attack Prevention

Enable HTTP limit

Limit period

Limit

Limit burst

	Field Name	Sample value	Explanation
1.	Enable HTTP limit	Enable/Disable	Limits HTTP connections per period
2.	Limit period	Second/Minute/Hour/Day	Select in what period limit HTTP connections
3.	Limit	"10"	Maximum HTTP connections during the period
4.	Limit burst	"10"	Indicating the maximum burst before the above limit kicks in.

7.6.6.5 HTTPS Attack Prevention

HTTPS Attack Prevention

Enable HTTPS limit

Limit period

Limit

Limit burst

	Field Name	Sample value	Explanation
1.	Enable HTTPS limit	Enable/Disable	Limits HTTPS connections per period
2.	Limit period	Second/Minute/Hour/Day	Select in what period limit HTTPS connections
3.	Limit	"10"	Maximum HTTPS connections during the period
4.	Limit burst	"10"	Indicating the maximum burst

7.6.7 Port Scan Prevention

7.6.7.1 Port Scan

Port Scan

Enable

Interval

Scan count

	Field Name	Sample value	Explanation
1.	Enable	Enable/Disable	Enable port scan prevention
2.	Interval	30	Time interval in seconds counting how much port scan (10 – 60 sec.)
3.	Scan count	10	How much port scan before blocked

7.6.7.2 Defending type

Defending type

SYN-FIN attack

SYN-RST attack

X-Mas attack

FIN scan

NULLflags attack

	Field Name	Explanation
1.	SYN-FIN attack	Protect from SYN-FIN attack
2.	SYN-RST attack	Protect from SYN-RST attack
3.	X-Mas attack	Protect from X-Mas attack
4.	FIN scan	Protect from FIN scan
5.	NULLflags attack	Protect from NULLflags attack

7.7 Routing

7.7.1 Static Routes

Static routes specify over which interface and gateway a certain host or network can be reached.

	Field name	Value	Explanation
1.	Routing table	MAIN/WAN/WAN2/WAN3	Defines the table to use for the route
2.	Interface	MAIN/WAN/WAN2/WAN3	The zone where the target network resides
3.	Destination address	IP address	The address of the destination network
4.	Netmask	IP mask	Mask that is applied to the Target to determine to what actual IP addresses the routing rule applies
5.	Gateway	IP address	To where the router should send all the traffic that applies to the rule
6.	Metric	integer	Used as a sorting measure. If a packet about to be routed fits two rules, the one with the higher metric is applied.

Additional note on Target & Netmask: You can define a rule that applies to a single IP like this: Target - some IP; Netmask - 255.255.255.255. Furthermore you can define a rule that applies to a segment of IPs like this: Target – some IP that STARTS the segment; Netmask – Netmask that defines how large the segment is. E.g.:

192.168.55.161	255.255.255.255	Only applies to 192.168.55.161
192.168.55.0	255.255.255.0	Applies to IPs in range 192.168.55.0-192.168.55.255
192.168.55.240	255.255.255.240	Applies 192.168.55.240 - 192.168.55.255
192.168.55.161	255.255.255.0	192.168.55.0 - 192.168.55.255
192.168.0.0	255.255.0.0	192.168.0.0 - 192.168.255.255

7.7.2 Dynamic Routes

7.7.2.1 General

Dynamic routes provide dynamic routing which enables router to select paths according to real-time logical network layout changes.

	Field name	Value	Explanation
1.	Enable	Enable/Disable	Enable dynamic routes
2.	Router ID	192.168.1.1	Router's ID

7.7.2.2 OSPF Protocol

7.7.2.2.1 OSPF General Instance

	Field name	Value	Explanation
1.	Enable	Enable/Disable	Enables OSPF protocol
2.	Stub	Enable/Disable	Enable/Disable stub
3.	RFC1583 compatibility	Enable/Disable	Enables OSPF compatibility with RFC1583 specification
4.	Import	All/None/custom	Set if the protocol must import routes
5.	Export	All/None/custom	Set if the protocol must export routes

7.7.2.2.2 OSPF Area

The OSPF network can be divided into sub-domains called areas.

OSPF Area			
Area name	Enable		
OSPF_area	No	<input type="button" value="Edit"/>	<input type="button" value="Delete"/>
New area name: <input type="text"/>		<input type="button" value="Add New"/>	

	Field name	Value	Explanation
1.	Area name	OSPF_area	OSPF area's name
2.	Enable	Yes/No	Enable/disable OSPF area

To see at specific configuration settings press **“edit”** button located in newly created OSPF area. A new page with detailed configuration appears, as shown in the picture below.

Area Instance: OSPF_area

Main Settings

Enabled

Stub

OSPF interface

Interface

There are no interfaces created yet

Interface

OSPF networks

IP **Hidden**

There are no networks created yet

New IP:

	Field name	Value	Explanation
1.	Enabled	Enable/Disable	Enable specific OSPF area
2.	Stub	Enable/Disable	Enable/disable stub
3.	Interface	br-lan	A interface that new instance will have
4.	New IP		Name of the new OSPF network configuration. Used for easier configurations management purpose only

7.7.2.3 General Protocol

The screenshot shows the 'General Protocols Configuration' window. At the top, there are tabs for 'General', 'OSPF Protocol', and 'General Protocols'. Below the tabs, the title 'General Protocols Configuration' is displayed. The interface is divided into two main sections: 'Kernel Options' and 'Device Options'.
Kernel Options:
 - 'Enable':
 - 'Learn':
 - 'Persist':
 - 'Scan time': 20
 - 'Import': All (dropdown)
 - 'Export': All (dropdown)
Device Options:
 - 'Enable':
 - 'Scan time': 10

	Field name	Value	Explanation
1.	Enable	Enable/Disable	Enable/Disable settings
2.	Learn	Enable/Disable	Enables routes learning
3.	Persist	Enable/Disable	If checked it allows to store routes. After a restart, routes will be still configured
4.	Scan time	20	Time between scans
5.	Import	All	Set if the protocol must import routes
6.	Export	All	Set if the protocol must export routes
7.	Enable	Enable/Disable	If checked the protocol will not be configured
8.	Scan time	10	Time between scans

7.7.2.3.1 Static Routes

The screenshot shows the 'Static Routes' configuration window. At the top, the title 'Static Routes' is displayed. Below the title, there are two columns: 'Prefix' and 'Type'. The text 'There are no static routes created yet' is shown in the center. Below this, there is a section titled 'New Static Route'. In this section, there is a 'Prefix' input field, a 'Type' dropdown menu set to 'Router', and an 'Add' button. At the bottom right, there is a 'Save' button.

	Field name	Explanation
1.	Prefix	Protocol prefix of incoming or outgoing packet
2.	Type	Protocol type of incoming or outgoing packet

7.8 Load Balancing

Load balancing lets users divide traffic between different interfaces.

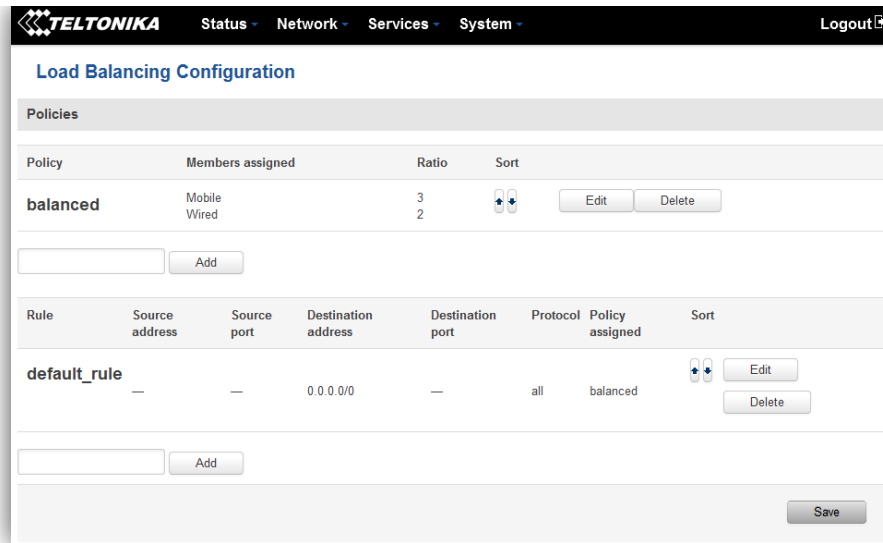

8 Remote monitoring and administration

RUT9XX supports multiple monitoring and administration possibilities. One can get routers information through SMS or using RMS (Remote Management System). Furthermore, some system related parameters can be obtained using MODBUS or MQTT publisher services. How to use them are described in the 9.19 and 9.20 chapters respectively. The main focus is on parameters, which change from time to time, like signal strength, operators name (it is quite common to change of operator name in countries where inner roaming is used) or module temperature. Although it is also possible to read more static values, like MAC address, router's serial number and many others. The access to the mentioned parameters is implemented in both MODBUS and MQTT publisher applications. Apart from getting of some parameters, MODBUS also supports setting of some system related parameter, for example, change value of digital output. Although it sounds frustrating, this functionality is sometimes useful and necessary.

Some applications, like MQTT publisher or RMS allows monitoring or administrating several routers from one place. It is very useful functionality, when you have few routers and would like to change some parameter using single application. RMS share some similarities with SSH (Secure Shell) and indeed, one of RMS feature is to allows SSH access to remote router. There is no separate chapter about RMS in this manual, because the interface of RMS is very intuitive and user friendly. You can access RMS by using your browser with supplied username and a password at <http://rms.teltonika.lt>

By sending SMS to the router the user can execute some command, like reboot, switch wifi on or off and many others. With each SMS the user need to specify router's administrator password. This is done for authentication purposes. The list of commands that may be executed through the SMS is limited. Full list of commands can be found on Services-SMS Utilities of routers WEB page. More about router's management using SMS can found in chapter 9.8.

Another interesting router monitoring solution is SNMP (Simple Network Management Protocol). By not going into deep details about this protocol, it is another manner to monitor router parameters. It allows the user to check current operator, modem model and other router parameters. Compared to other applications and services, only SNMP have ability to inform the user about the occurrence of specific event (called trap) in the system. The main drawback of this protocol is, that it does not allow to change anything. You can read more about SNMP in chapter 8.9.

Apart from services mentioned earlier, there is one service, which is used only for communication between router and Android type device (phones, etc'). It is called json-rpc and allows to set or get various parameters of the system. JSON-RPC can execute the same commands, like user through SSH. To sum up, this approach opens wide possibilities in communication between router and Android. However, there is no separate topic about JSON-RPC in this manual, because this type of communication is generally not for end-user use.

Each approach has its advantages and disadvantages. In some situations, maybe MQTT publisher works better than MODBUSD, while in others, MODBUSD will be the better choice. The most versatile manner of system monitoring and administration is through SSH. The SSH provides complete control of the router. The user can execute commands, write shell scripts and do many other things. In such case, the user only needs application to connect router through SSH. The most popular application used in Windows type operating systems is called Putty. If you try to connect to router from Unix like operating system, you only need to execute ssh command with some arguments, like hostname and username (in this case – root).

Sometimes the use of SSH is not necessary, so other more conservative services/applications are used. The complete list of applications and services, which can be used for router administration and monitoring are given below. It can be seen, that all applications, except MQTT publisher and SNMP supports setting/getting of some system related parameter.

	Application	Can obtain parameters	Can set parameters
1.	MQTT publisher	•	○
2.	MODBUS daemon	•	•
3.	SSH	•	•
4.	RMS	•	•
5.	SMS	•	•
6.	SNMP	•	○
7.	JSON-RPC	•	•

By summarizing, RUT9XX provides several solutions for router management. Each user can choose what solution to use. If required functionality is not found in particular service, the user can combine several applications, for example, use MQTT publisher along with SNMP. Finally, if user has special needs, he can write shell script and execute it via SSH or use json-rpc.

9 Services

9.1 VRRP

9.1.1 VRRP LAN Configuration Settings

VRRP LAN Configuration Settings

Enable

IP address 

Virtual ID

Priority

	Field name	Sample	Explanation
1.	Enable	Enable/Disable	Enable VRRP (Virtual Router Redundancy Protocol) for LAN
2.	IP address	192.168.1.253	Virtual IP address for LAN's VRRP (Virtual Router Redundancy Protocol) cluster
3.	Virtual ID	1	Routers with same IDs will be grouped in the same VRRP (Virtual Router Redundancy Protocol) cluster, range [1-255]
4.	Priority	100	Router with highest priority value on the same VRRP (Virtual Router Redundancy Protocol) cluster will act as a master, range [1-255]

9.1.2 Check Internet connection

Check internet connection

Enable

Ping IP address

Ping interval

Ping timeout (sec)

Ping packet size

Ping retry count

	Field name	Sample	Explanation
1.	Enable	Enable/Disable	Enable WAN's connection monitoring
2.	Ping IP address	8.8.4.4	A host to send ICMP (Internet Control Message Protocol) packets to
3.	Ping interval	10	Time interval in seconds between two Pings
4.	Ping timeout (sec)	1	Response timeout value, interval [1 - 9999]
5.	Ping packet size	50	ICMP (Internet Control Message Protocol) packet's size, interval [0 - 1000]
6.	Ping retry count	100	Failed Ping attempt's count before determining that connection is lost, interval [1 - 9999]

9.2 TR-069

TR-069 is a standard developed for automatic configuration and management of remote devices by Auto Configuration Servers (ACS).

9.2.1 TR-069 Parameters Configuration

TR-069 Parameters Configuration

Enable

Enable Periodic Transmission

User name

Password 

URL

	Field name	Sample	Explanation
1.	Enable	Enable/Disable	Enable TR-069 client
2.	Enable Periodic Transmission	Enable / Disable	Enable periodic transmissions of data to server
3.	User name	admin	User name for authentication on TR-069 server
4.	Password	*****	Password for authentication on TR-069 server
5.	URL	http://192.168.1.110:8080	TR-069 server URL address

9.3 Web filter

9.3.1 Site blocking

Site Blocking

Proxy Based Content Blocker

Site Blocking Settings

Site Blocking

Enable

Mode Whitelist ▼

Enable	Host name	
<input checked="" type="checkbox"/>	www.yahoo.com	Delete
Add		

	Field name	Sample	Explanation
1.	Enable	Enable/Disable	Enable host name based websites blocking
2.	Mode	Whitelist/Blacklist	Whitelist - allow every site on the list and block everything else. Blacklist - block every site on the list and allow everything else.
3.	Enable	Enable/Disable	Check to enable site blocking
4.	Host name	www.yahoo.com	Block/allow site with this hostname

9.3.2 Proxy Based Content Blocker

Site Blocking

Proxy Based Content Blocker

Proxy Based URL Content Blocker Configuration

Proxy Based URL Content Blocker

Enable

Mode Blacklist ▼

URL Filter Rules

Enable	URL content	
<input checked="" type="checkbox"/>	example.com	Delete

	Field name	Sample	Explanation
1.	Enable	Enable/Disable	Enable proxy server based URL content blocking. Works with HTTP protocol only
2.	Mode	Whitelist/Blacklist	Whitelist - allow every part of URL on the list and block everything else. Blacklist - block every part of URL on the list and allow everything else
3.	URL content	example.com	Block/allow any URL containing this string. Example.com, example.*, *.example.com

9.4 NTP

NTP configuration lets you setup and synchronize routers time.

The screenshot shows a configuration page for NTP. At the top, there are tabs for 'General' and 'Time Servers', with 'Time Servers' selected. The main heading is 'Time Synchronisation'. Below this, there is a 'General' section containing the following fields: 'Current system time' (2016-03-09 08:32:52) with a 'Sync with browser' button; 'Time zone' (UTC) with a dropdown arrow; 'Enable NTP' (checked checkbox); 'Update interval (in seconds)' (3600); 'Save time to flash' (unchecked checkbox); and 'Count of time synchronizations' (empty text box). Below the 'General' section is a 'Clock Adjustment' section with an 'Offset frequency' field (0). A 'Save' button is located at the bottom right of the form.

	Field name	Description
1.	Current System time	Local time of router.
2.	Time zone	Time zone of your country.
3.	Enable NTP	Enable system's time synchronization with time server using NTP (Network Time

		Protocol)
4.	Update interval	How often router updates systems time
5.	Save time to flash	Save last synchronized time to flash memory
6.	Count of time synchronizations	Total amount of times that router will do the synchronization. Note: If left blank - the count will be infinite
7.	Offset frequency	Adjust the minor drift of the clock so that it will be more accurate

Note, that under **Time Servers** at least one server has to be present, otherwise NTP will not serve its purposes.

9.5 RS232/RS485

RS232 and RS485 functions are designed to utilize available serial interfaces of the router. Serial interfaces provide possibility for legacy devices to gain access to IP networks.

9.5.1 RS232

	Field name	Sample	Explanation
1.	Enabled	Enable/Disable	Check the box to enable the serial port function.
2.	Baud rate	300 / 115200	Select the communication speed of the serial interface.
3.	Data bits	5 - 8	Specifies how many bits will be used for character
4.	Parity	None / Odd / Even	Select the parity bit setting used for error detection during data transfer.
5.	Stop bits	1 / 2	Specifies how many stop bits will be used to detect the end of character
6.	Flow control	None / RTS- CTS / Xon-Xoff	Specifies what kind of characters to use for flow control
7.	Serial type	Console / Over IP / Modem / Modbus Gateway	Specifies function of serial interface
8.	Interface	LAN/ WAN/ VPN	Interface used for connection
9.	Allow IP	192.168.1.102	Allow IP connecting to server

9.5.1.1 RS232 connector pinout

RS232 connector type on this device is DCE female. DCE stands for Data Communication Equipment.



Pin	Name*	Description*	Direction on this device
1	DCD	Data Carrier Detect	Output
2	RXD	Receive Data	Output
3	TXD	Transmit Data	Input
4	DTR	Data Terminal Ready	Input
5	GND	Signal Ground	-
6	DSR	Data Set Ready	Output
7	RTS	Ready To Send	Input
8	CTS	Clear to send	Output
9	RI	Ring indicator	Output (connected to +5V permanently via 4.7k resistor)

*The names and descriptions that indicate signal direction (such as TXD, RXD, RTS, CTS, DTR, and DSR) are named from the point of view of the DTE device.

9.5.1.2 Cables

RUT9xx has DCE female connector. To connect a standard DTE device to it, use straight-through Female/Male RS232 cable:



To connect another DCE device to RUT9xx, a Null-modem (crossed) Female/Female cable should be used:



Maximum cable length is 15meters, or the cable length equal to a capacitance of 2500 pF (for a 19200 baud rate). Using lower capacitance cables can increase the distance. Reducing communication speed also can increase maximum cable length. The following table lists boud rate vs. Maximum cable length.

9.5.2 RS485

RS-485 is differential serial data transmission standard for use in long ranges or noisy environments.

	Field name	Sample	Explanation
1.	Enabled	Enable/Disable	Check the box to enable the serial port function.
2.	Baud rate	300 / 115200	Select the communication speed of the serial interface.
3.	Parity	None / Odd / Even	Select the parity bit setting used for error detection during data transfer.
4.	Flow control	None / RTS- CTS / Xon-Xoff	Specifies what kind of characters to use for flow control
5.	Serial type	Console / Over IP / Modem / Modbus Gateway	Specifies function of serial interface
6.	Interface	LAN/ WAN/ VPN	Interface used for connection
7.	Allow IP	192.168.1.102	Allow IP connecting to server

9.5.2.1 Maximum data rate vs. transmission line length

RS-485 standard can be used for network lengths up to 1200 meters, but the maximum usable data rate decreases as the transmission length increases. Device operating at maximum data rate (10Mbps) is limited to transmission length of about 12 meters, while the 100kbps data rate can achieve a distance up to 1200 meters. A rough relation between maximum transmission length and data rate can be calculated using approximation:

$$L_{max}(m) = \frac{10^8}{DR(bit/s)}$$

Where L_{max} is maximum transmission length in meters and DR is maximum data rate in bits per second.

Twisted pair is the preferred cable for RS-485 networks. Twisted pair cables pick up noise and other electromagnetically induced voltages as common mode signals, which are rejected by the differential receivers.

9.5.2.2 Cable type

Recommended cable parameters:

Parameter	Value
Cable Type	22-24 AWG, 2 – pair (used for full-duplex networks) or 1-pair (used for half duplex networks). One additional wire for ground connection is needed.
Characteristic cable Impedance	120 Ω @ 1MHz
Capacitance (conductor to conductor)	36 pF/m
Propagation Velocity	78% (1.3 ns/ft)

9.5.2.3 RS485 connector pin-out

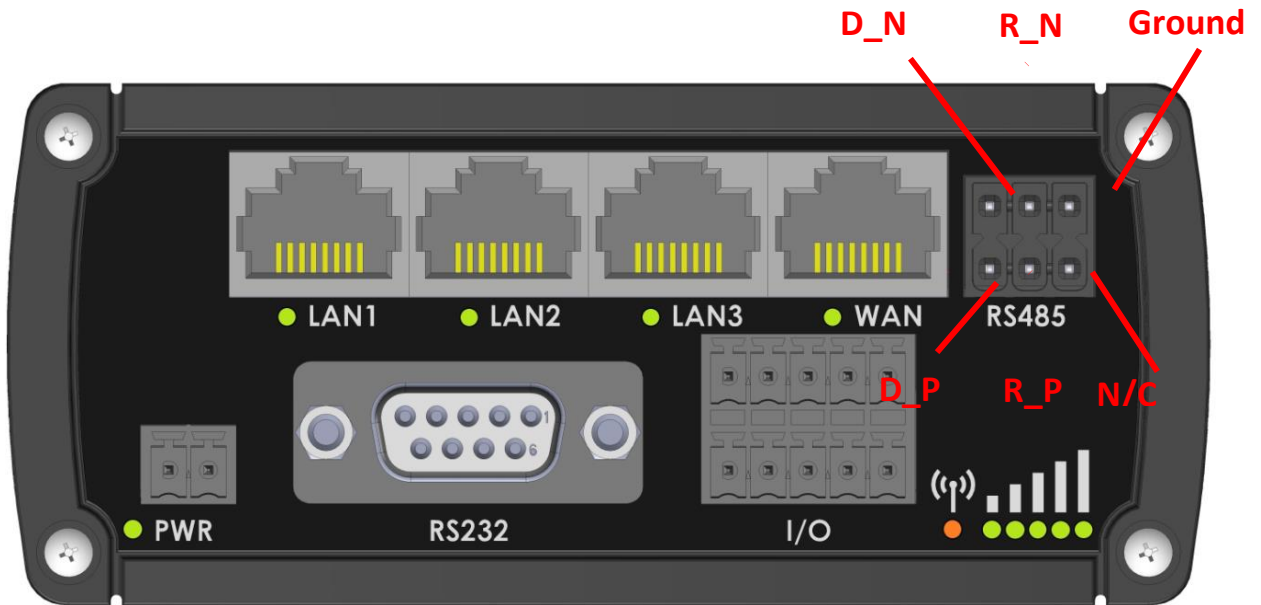

Name	Description	Type
D_P	Driver positive signal	Differential Output
D_N	Driver negative signal	Differential Output
R_P	Receiver positive signal	Differential input
R_N	Receiver negative signal	Differential input
Ground	Device ground	Differential Output

9.5.2.4 2-Wire and 4-Wire Networks

Below is an example of 4- wire network electrical connection. There are 3 devices shown in the example. One of the devices is master and other two- slaves. Termination resistors are placed at each cable end. Four-wire networks consists of one „master“ with its transmitter connected to each of the “slave” receivers on one twisted pair. The “slave” transmitters are all connected to the “master” receiver on a second twisted pair.

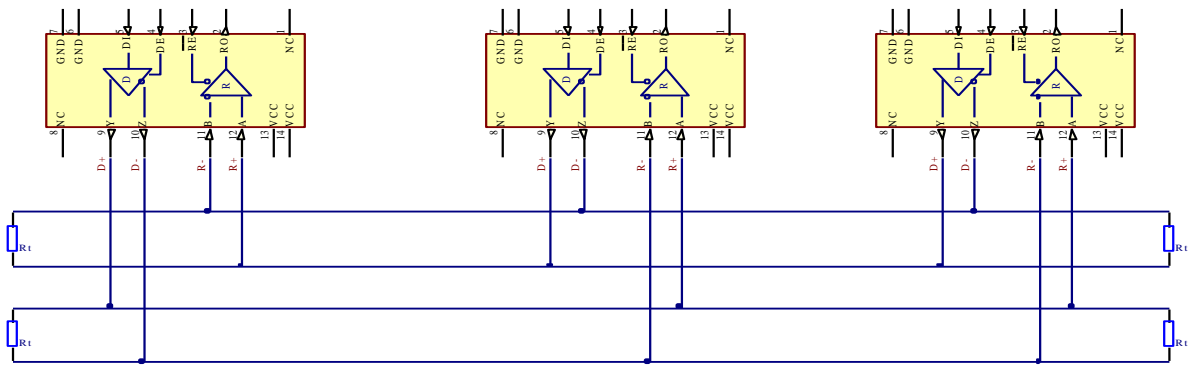

Example 2-wire network electrical connection: to enable 2-wire RS-485 configuration in Teltonika router, you need to connect D_P to R_P and D_N to R_N at the device RS-485 socket. Termination resistors are placed at each cable end.

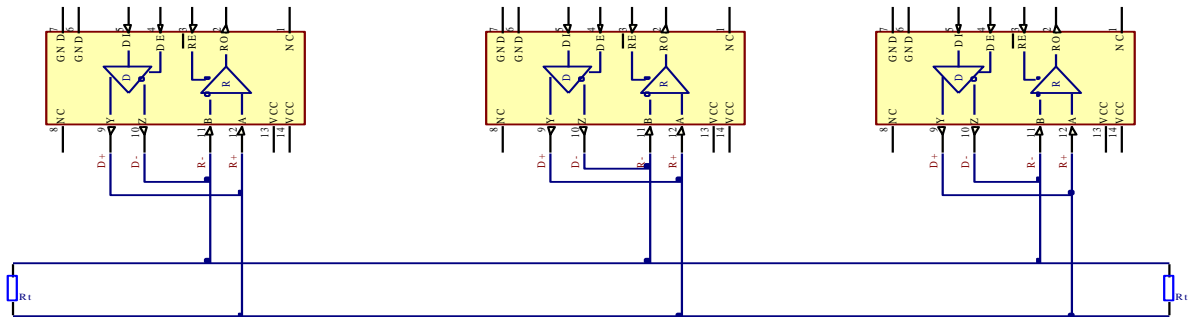

9.5.2.5 Termination

When to use (place jumper)

Termination resistor, equal in resistance to cable characteristic impedance, must be connected at each end of the cable to reduce reflection and ringing of the signals when the cable lengths get relatively long. Rise time of the RUT9XX RS-485 driver is about 5ns, so maximum unterminated cable length is about 12cm. As transmission line cables will be always longer than 12 cm, termination is mandatory all the time if RUT9xx is located at the end of the cable.

When not to use (remove jumper)

If your RS-485 consists of more than two devices and RUT9xx router is located not on the end of the line, for example at the middle, RUT9xx termination resistor needs to be disabled. In this case, please termination at other devices which are situated at the ends of the line.

How to enable termination

120 Ω termination resistor is included on RUT9xx PCB and can be enabled by shorting contacts (shown in the picture below), placing 2.54mm pitch jumper:

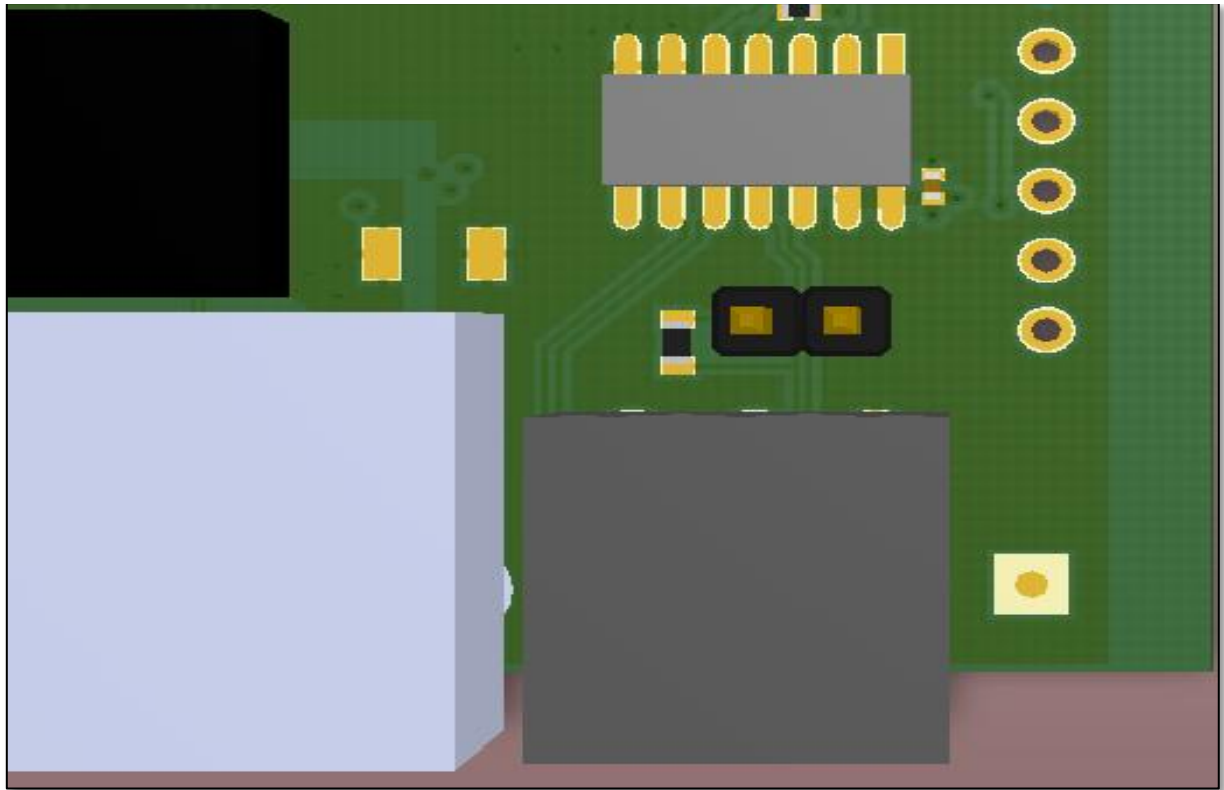

9.5.2.6 Number of devices in RS-485 Network

One RUT9xx RS-485 driver is capable of driving maximum 32 receivers, provided that receiver input impedance is 12kΩ. If receiver impedances are higher, maximum number of receivers in network increases. Any combination of receiver types can be connected together, provided their parallel impedance does not exceed $R_{Load} > 375\Omega$.

9.5.3 Modes of different serial types in RS232 and RS485

9.5.3.1 Console mode

In this mode the serial interface set up as Linux console of the device. It can be used for debug purposes, to get the status of the device or to control it.

9.5.3.2 Over IP mode

In this mode the router provides connection to TCP/IP network for the devices connected via serial interfaces.

Serial type	Over IP
Protocol	TCP
Mode	Server
TCP port	<input type="text"/>
Timeout (s)	<input type="text"/>

Field name	Explanation
1. Protocol	Select which protocol to use for data transmission

2.	Mode	Select mode to apply for router. Server - wait for incoming connection. Client - initiate the connection. Bidirect – On default acts like client, but at the same time waits for incoming connections.
3.	TCP port	Specify port number that will be used to listen for incoming connections (Server) or port of the remote server (Client)
4.	Timeout (s)	Disconnect client if not active connection

Client:

Mode

Server Address

TCP port

Reconnect interval (s)

	Field name	Explanation
1.	Server Address	Specify server address which client have to connect
2.	TCP port	Specify port number that will be used to listen for incoming connections (Server) or port of the remote server (Client)
3.	Reconnect intervals (s)	Specify intervals connection to server if it fails

Bidirect:

Bidirect mode allows bi-directional communication through serial interface. In default state application acts like client, but at the same time, listens to any incoming connections on dedicated port. When there is connection incoming the application drops current connection to remote server and acts like a server to the new connection. This triggers configured output change, which can be used to inform any auxiliary devices about connection status change. When the client connection is terminated application returns to default mode and continues as a client to remote server.

Mode

No leading zeros

Client settings:

Server Address

TCP port

Reconnect interval (s)

Server settings:

TCP port

Timeout (s)

Output

Output state

	Field name	Explanation
1.	Server Address	Specify server address which client will connect to
2.	TCP port	Specify port number to connect to (Client settings) or listen for incoming connections (Server settings)
3.	Reconnect intervals (s)	Specify time intervals for reconnection to server if connection fails
4.	TCP port	Specify port number that will be used to listen for incoming connections (Server settings) or port of the remote server to connect (Client settings)
5.	Timeout (s)	Timeout period for inactive client connections
6.	Output	Output (OC or Relay) to indicate that application switched from client (default) to server state
7.	Output state	Output state value (0 or 1), when application reverts to server mode

9.5.3.3 Modem mode

In this mode the router imitates dial-up modem. Connection to TCP/IP network can be established using AT commands. The connection can be initiated by the device connected via serial interface with ATD command:

ATD<host>:<port>. If **Direct connect** settings are specified the connection to the server is always active. Data mode can be entered by issuing ATD command. Incoming connection is indicated by sending RING to the serial interface.

Serial type: Modem
 Direct connect: 1.1.1.1:321
 TCP port: 123

	Field name	Explanation
1.	Direct connect	Enter hostname:port to maintain constant connection to specified host. Leave empty to use ATD command to initiate connection.
2.	TCP port	Specify TCP port number that will be used to listen for incoming connections. Leave it empty to disable incoming connections.

This is the AT command set used in **Modem** mode of the serial interfaces:

Command	Description	Usage
A	Answer incoming call	To answer incoming connection: ATA
D	Dial a number	To initiate data connection: ATD<host>:<port> To enter data mode with Direct connect settings: ATD
E	Local echo	Turn local echo on: ATE1 Turn local echo off: ATE0
H	Hang up current call	To end data connection: ATH
O	Return to data mode	To return to data mode from command mode: ATO
Z	Reset to default configuration	To reset the modem to default configuration: ATZ

9.5.3.4 Modbus Gateway mode

This mode allows redirecting TCP data coming to specified port to RTU specified by slave ID. As we can see later, slave ID can be specified by the user or can be obtained directly from the Modbus header.

Serial type: Modbus gateway
 Listening IP: 0.0.0.0
 Port: 502
 Slave ID configuration type: User defined
 Slave ID: 1

Slave ID configuration type

Permitted slave IDs

	Field name	Explanation
1.	Listening IP	IP address on which Modbus gateway should wait for incoming connections
2.	Port	Port number for Modbus Gateway
3.	Slave ID configuration type	There are two options available for this parameter. "User defined" redirects all data to slave ID specified by the parameter "Slave ID". "Obtain from TCP" redirects data to slave ID according to Modbus TCP header
4.	Slave ID	ID of the Modbus TCP slave device which is connected to the router
5.	Permitted slave IDs	Allows specifying the list of permitted slave IDs for redirecting of the Modbus TCP data. Individual values can be separated using ',' (comma), while the range can be specified using '-' (hyphen), e.g., 1,2,4-6. All other slave IDs not listed here are ignored.

9.6 VPN

9.6.1 OpenVPN

VPN (Virtual Private Network) is a method for secure data transfer through unsafe public network. This section explains how to configure OpenVPN, which is implementation of VPN supported by the RUT9 router.

A picture below demonstrates default OpenVPN configurations list, which is empty, so you have to define a new configuration to establish any sort of OpenVPN connection. To create it, enter desired configuration name in "New configuration name" field, select device role from "Role" drop down list. For example, to create an OpenVPN client with configuration name demo, select client role, name it "demo" and press "Add New" button as shown in the following picture.

OpenVPN IPsec GRE Tunnel PPTP L2TP

New OpenVPN instance was created successfully. Configure it now

OpenVPN

OpenVPN Configuration

Tunnel name	TUN/TAP	Protocol	Port	Enable		
Client_demo	Tun_c_demo	UDP	1194	<input type="checkbox"/>	Edit	Delete

Role: Client New configuration name:

To see at specific configuration settings press **“edit”** button located in newly created configuration entry. A new page with detailed configuration appears, as shown in the picture below (TLS client example).

OpenVPN Instance: Client_demo

Main Settings

Enable

TUN/TAP

Protocol

Port

LZO

Encryption

Authentication

TLS cipher

Remote host/IP address

Resolve retry

Keep alive

Remote network IP address

Remote network IP netmask

Max routes

HMAC authentication algorithm

Additional HMAC authentication

Certificate authority No file selected.

Client certificate No file selected.

Client key No file selected.

There can be multiple server/client instances.

You can set custom settings here according to your VPN needs. Below is summary of parameters available to set:

	Field name	Explanation
1.	Enabled	Switches configuration on and off. This must be selected to make configuration active.
2.	TUN/TAP	Selects virtual VPN interface type. TUN is most often used in typical IP-level VPN connections, however, TAP is required to some Ethernet bridging configurations.
3.	Protocol	Defines a transport protocol used by connection. You can choose here between TCP and UDP.
4.	Port	Defines TCP or UDP port number (make sure, that this port allowed by firewall).
5.	LZO	This setting enables LZO compression. With LZO compression, your VPN connection will generate less network traffic; however, this means higher router CPU loads. Use it carefully with high rate traffic or low CPU resources.

6.	Encryption	Selects Packet encryption algorithm.
7.	Authentication	Sets authentication mode, used to secure data sessions. Two possibilities you have here: "Static key" means, that OpenVPN client and server will use the same secret key, which must be uploaded to the router using "Static pre-shared key" option. "TLS" authentication mode uses X.509 type certificates. Depending on your selected OpenVPN mode (client or server) you have to upload these certificates to the router: For client: Certificate Authority (CA), Client certificate, Client key. For server: Certificate Authority (CA), Server certificate, Server key and Diffie-Hellman (DH) certificate used to key exchange through unsafe data networks. All mention certificates can be generated using OpenVPN or Open SSL utilities on any type host machine. Certificate generation and theory is out of scope of this user manual.
8.	TLS cipher	Packet encryption algorithm (cipher)
9.	Remote host/IP address	IP address of OpenVPN server (applicable only for client configuration).
10.	Resolve Retry	Sets time in seconds to try resolving server hostname periodically in case of first resolve failure before generating service exception.
11.	Keep alive	Defines two time intervals: one is used to periodically send ICMP request to OpenVPN server, and another one defines a time window, which is used to restart OpenVPN service, if no ICMP request is received during the window time slice. Example Keep Alive "10 60"
12.	Remote network IP address	IP address of remote network, an actual LAN network behind another VPN endpoint.
13.	Remote network IP netmask	Subnet mask of remote network, an actual LAN network behind another VPN endpoint.
14.	Max routes	Allow a maximum number of routes to be pulled from an OpenVPN server
15.	HMAC authentication algorithm	Sets HMAC authentication algorithm
16.	Additional HMAC authentication	Add an additional layer of HMAC authentication on top of the TLS control channel to protect against DoS attacks
17.	Certificate authority	Certificate authority is an entity that issues digital certificates. A digital certificate certifies the ownership of a public key by the named subject of the certificate.
18.	Client certificate	Client certificate is a type of digital certificate that is used by client systems to make authenticated requests to a remote server. Client certificates play a key role in many mutual authentication designs, providing strong assurances of a requester's identity.
19.	Client key	Authenticating the client to the server and establishing precisely who they are

After setting any of these parameters press **"Save"** button. Some of selected parameters will be shown in the configuration list table. You should also be aware of the fact that router will launch separate OpenVPN service for every configuration entry (if it is defined as active, of course) so the router has ability to act as server and client at the same time.

9.6.2 IPsec

The IPsec protocol client enables the router to establish a secure connection to an IPsec peer via the Internet. IPsec is supported in two modes - transport and tunnel. Transport mode creates secure point to point channel between two hosts. Tunnel mode can be used to build a secure connection between two remote LANs serving as a VPN solution.

IPsec system maintains two databases: Security Policy Database (SPD) which defines whether to apply IPsec to a packet or not and specify which/how IPsec-SA is applied and Security Association Database (SAD), which contain Key of each IPsec-SA.

The establishment of the Security Association (IPsec-SA) between two peers is needed for IPsec communication. It can be done by using manual or automated configuration.

Note: router starts establishing tunnel when data from router to remote site over tunnel is sent. For automatic tunnel establishment used tunnel Keep Alive feature.

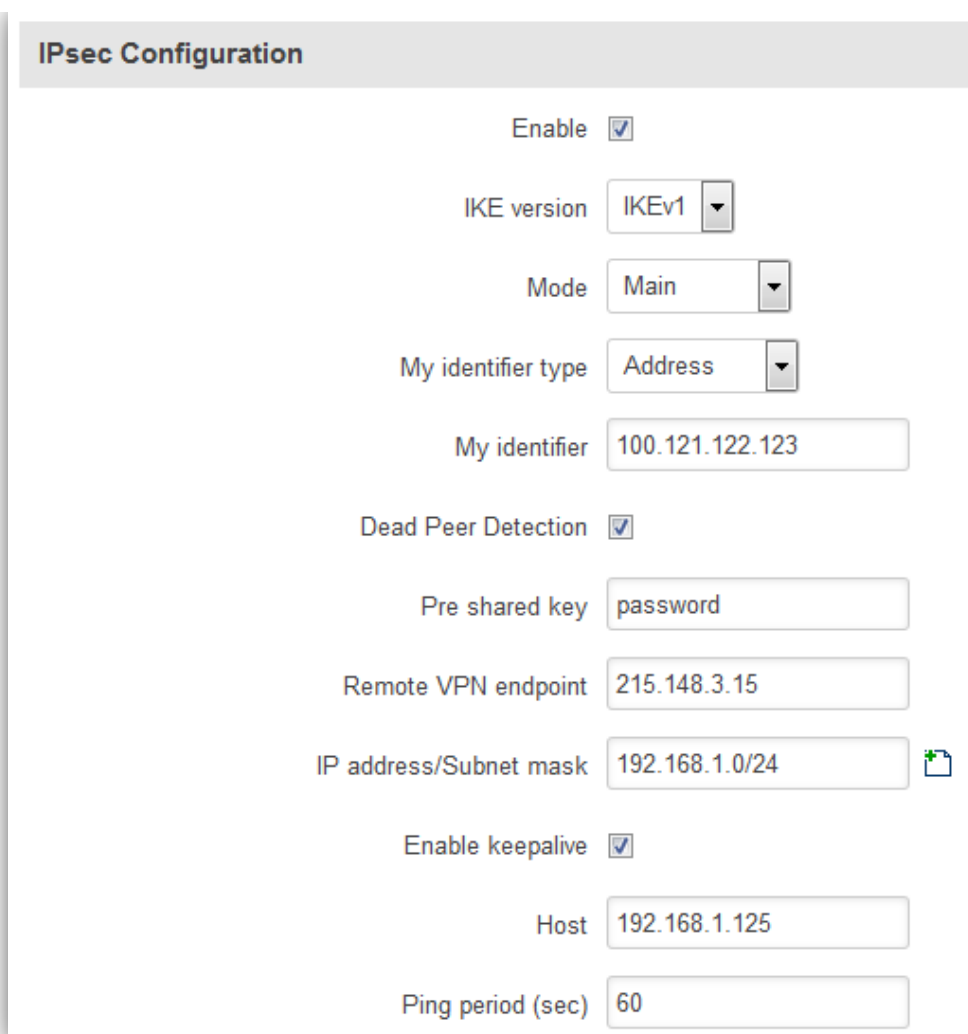

The screenshot shows the 'IPsec Configuration' interface with the following settings:

- Enable:
- IKE version: IKEv1
- Mode: Main
- My identifier type: Address
- My identifier: 100.121.122.123
- Dead Peer Detection:
- Pre shared key: password
- Remote VPN endpoint: 215.148.3.15
- IP address/Subnet mask: 192.168.1.0/24
- Enable keepalive:
- Host: 192.168.1.125
- Ping period (sec): 60

	Field name	Value	Explanation
1.	Enable	Enabled/Disabled	Check box to enable IPsec.
2.	IKE version	IKEv1 or IKEv2	Method of key exchange
3.	Mode	“Main” or “Aggressive”	ISAKMP (Internet Security Association and Key Management Protocol) phase 1 exchange mode
4.	My identifier type	Address, FQDN, User FQDN	Choose one accordingly to your IPsec configuration
5.	My identifier		Set the device identifier for IPsec tunnel. In case RUT has Private IP, its identifier should be its own LAN network address. In this way, the Road Warrior approach is possible.
6.	Dead Peer Detection	Enabled/Disabled	The values clear, hold and restart all active DPD
7.	Pre shared key		A shared password to authenticate between the peer

8.	Remote VPN endpoint		Domain name or IP address. Leave empty or any
9.	IP address/Subnet mask		Remote network secure group IP address and mask used to determine to what subnet an IP address belongs to. Range [0-32]. IP should differ from device LAN IP
10.	Enable keep alive	Enabled/Disabled	Enable tunnel keep alive function
11.	Host		A host address to which ICMP (Internet Control Message Protocol) echo requests will be send
12.	Ping period (sec)		Send ICMP echo request every x seconds. Range [0-999999]

Phase 1 and **Phase 2** must be configured accordingly to the IPsec server configuration, thus algorithms, authentication and lifetimes of each phase must be identical.

The image shows two screenshots of IPsec phase configuration windows. The top window is for Phase 1, and the bottom window is for Phase 2. Both windows have a title 'Phase' and a subtitle 'The phase must match with another incoming connection to establish IPsec'. The Phase 1 window has tabs for 'Phase 1' and 'Phase 2', with 'Phase 1' selected. It shows the following settings: Encryption algorithm: 3DES, Authentication: SHA1, DH group: MODP1536, and Lifetime (h): 8 Minutes. The Phase 2 window has tabs for 'Phase 1' and 'Phase 2', with 'Phase 2' selected. It shows the following settings: Encryption algorithm: 3DES, Hash algorithm: SHA1, PFS group: MODP1536, and Lifetime (h): 8 Hours.

	Field name	Value	Explanation
1.	Encryption algorithm	DES, 3DES, AES 128, AES 192, AES256	The encryption algorithm must match with another incoming connection to establish IPsec
2.	Authentication	MD5, SHA1, SHA256, SHA384, SHA512	The authentication algorithm must match with another incoming connection to establish IPsec
3.	Hash algorithm	MD5, SHA1, SHA256, SHA384, SHA512	The hash algorithm must match with another incoming connection to establish IPsec
4.	DH group	MODP768, MODP1024, MODP1536, MODP2048, MODP3072, MODP4096	The DH (Diffie-Helman) group must with another incoming connection to establish IPsec
4.	PFS group	MODP768, MODP1024, MODP1536, MODP2048, MODP3072, MODP4096, No PFS	The PFS (Perfect Forward Secrecy) group must match with another incoming connection to establish IPsec
5.	Lifetime	Hours, Minutes, Seconds	The time duration for phase

9.6.3 GRE Tunnel

GRE (Generic Routing Encapsulation RFC2784) is a solution for tunneling RFC1812 private address-space traffic over an intermediate TCP/IP network such as the Internet. GRE tunneling does not use encryption it simply encapsulates data and sends it over the WAN.

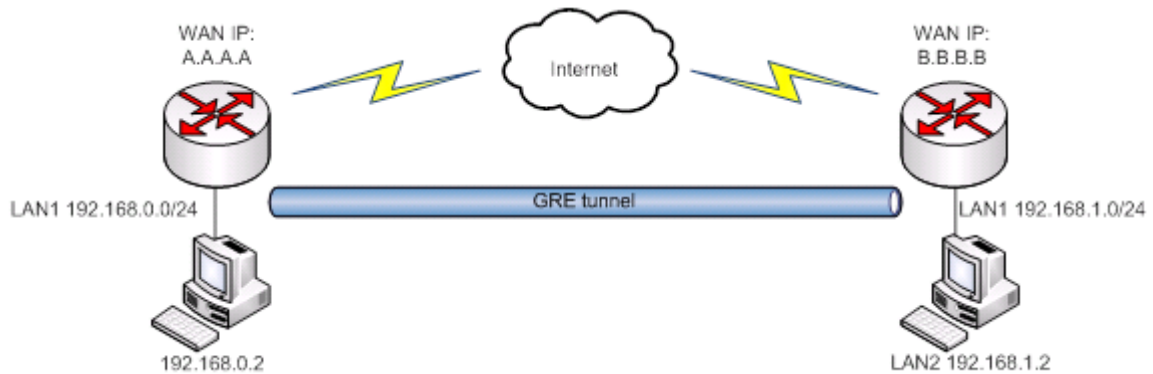

In the example network diagram two distant networks LAN1 and LAN2 are connected.

To create GRE tunnel the user must know the following parameters:

1. Source and destination IP addresses.
2. Tunnel local IP address
3. Distant network IP address and Subnet mask.

OpenVPN	IPsec	GRE Tunnel	PPTP	L2TP
Gre-tunnel Instance: Gre_tunnel				
Main Settings				
Enabled <input checked="" type="checkbox"/>				
Remote endpoint IP address	<input type="text" value="84.148.7.87"/>			
Remote network	<input type="text" value="192.168.2.0"/>			
Remote network netmask	<input type="text" value="24"/>			
Local tunnel IP	<input type="text" value="10.0.0.1"/>			
Local tunnel netmask	<input type="text" value="24"/>			
MTU	<input type="text" value="1500"/>			
TTL	<input type="text" value="255"/>			
PMTUD <input checked="" type="checkbox"/>				
Enable Keep alive <input checked="" type="checkbox"/>				
Keep Alive host	<input type="text"/>			
Keep Alive interval	<input type="text"/>			

	Field name	Explanation
1.	Enabled	Check the box to enable the GRE Tunnel function.
2.	Remote endpoint IP address	Specify remote WAN IP address.
3.	Remote network	IP address of LAN network on the remote device.
4.	Remote network netmask	Network of LAN network on the remote device. Range [0-32].
5.	Local tunnel IP	Local virtual IP address. Cannot be in the same subnet as LAN network.
6.	Local tunnel netmask	Network of local virtual IP address. Range [0-32]
7.	MTU	Specify the maximum transmission unit (MTU) of a communications protocol of a layer in bytes.
8.	TTL	Specify the fixed time-to-live (TTL) value on tunneled packets [0-255]. The 0 is a special value meaning that packets inherit the TTL value.
9.	PMTUD	Check the box to enable the Path Maximum Transmission Unit Discovery (PMTUD) status on this tunnel.
10.	Enable Keep alive	It gives the ability for one side to originate and receive keep alive packets to and from a remote router even if the remote router does not support GRE keep alive.
11.	Keep Alive host	Keep Alive host IP address. Preferably IP address which belongs to the LAN network on the remote device.
12.	Keep Alive interval	Time interval for Keep Alive. Range [0 - 255].

9.6.4 PPTP

Point-to-Point Tunneling Protocol (PPTP) is a protocol (set of communication rules) that allows corporations to extend their own corporate network through private "tunnels" over the public Internet. Effectively, a corporation uses a wide-area network as a single large local area network. A company no longer needs to lease its own lines for wide-area communication but can securely use the public networks. This kind of interconnection is known as a virtual private network (VPN).

	Field name	Explanation
1.	Enable	Check the box to enable the PPTP function.
2.	Local IP	IP Address of this device (RUT)
3.	Remote IP range begin	IP address leases beginning
4.	Remote IP range end	IP address leases end
5.	Username	Username to connect to PPTP (this) server
6.	Password	Password to connect to PPTP server
7.	User IP	Users IP address

	Field name	Explanation
1.	Enable	Enable current configuration

2.	Use as default gateway	Use this PPTP instance as default gateway
3.	Server	The server IP address or hostname
4.	Username	The user name for authorization with the server
5.	Password	The password for authorization with the server

9.6.5 L2TP

Allows setting up a L2TP server or client. Below is L2TP server configuration example.

	Field name	Explanation
1.	Enable	Check the box to enable the L2TP Tunnel function.
2.	Local IP	IP Address of this device (RUT)
3.	Remote IP range begin	IP address leases beginning
4.	Remote IP range end	IP address leases end
5.	Username	Username to connect to L2TP (this) server
6.	Password	Password to connect to L2TP server

Client configuration is even simpler, which requires only **Servers IP, Username and Password.**

9.7 Dynamic DNS

Dynamic DNS (DDNS) is a domain name service allowing to link dynamic IP addresses to static hostname.

To start using this feature firstly you should register to DDNS service provider (example list is given in description).

You are provided with add/delete buttons to manage and use different DDNS configurations at the same time!

You can configure many different DDNS Hostnames in the main DDNS Configuration section.

DDNS name	Hostname	Status	Enable
Myddns	yourhost.example.org	N/A	<input type="checkbox"/>

New configuration name:

To edit your selected configuration, hit **Edit**.

Enable

Status N/A

Service 3322.org

Hostname yourhost.example.org

User name your_username

Password

IP source Custom

Network WAN

IP renew interval (min) 10

Force IP renew (min) 472

	Field name	Value	Explanation
1.	Enable	Enable/Disable	Enables current DDNS configuration.
2.	Status		Timestamp of the last IP check or update.
3.	Service	1. dydns.org 2. 3322.org 3. no-ip.com 4. easydns.com 5. zoneedit.com	Your dynamic DNS service provider selected from the list. In case your DDNS provider is not present from the ones provided, please feel free to use "custom" and add hostname of the update URL.
4.	Hostname	yourhost.example.org	Domain name which will be linked with dynamic IP address.
5.	Username	your_username	Name of the user account.
6.	Password	your_password	Password of the user account.
7.	IP Source	Public Private Custom	This option allows you to select specific RUT interface, and then send the IP address of that interface to DDNS server. So if, for example, your RUT has Private IP (i.e. 10.140.56.57) on its WAN (3G interface), then you can send this exact IP to DDNS server by selecting "Private", or by selecting "Custom" and "WAN" interface. The DDNS server will then resolve hostname queries to this specific IP.

8.	Network	WAN	Source network
9.	IP renew interval (min)	10 (minutes)	Time interval (in minutes) to check if the IP address of the device have changed.
10.	Force IP renew	472 (minutes)	Time interval (in minutes) to force IP address renew.

9.8 SMS Utilities

RUT955 has extensive amount of various SMS Utilities. These are subdivided into 6 sections: SMS Utilities, Call Utilities, User Groups, SMS Management, Remote Configuration and Statistics.

9.8.1 SMS Utilities

The screenshot shows the 'SMS Utilities' configuration page in the Teltonika web interface. The page features a navigation bar with 'Status', 'Network', 'Services', and 'System' menus, and a 'Logout' button. Below the navigation bar, there are tabs for 'SMS Utilities', 'Call Utilities', 'User Groups', 'SMS Management', 'Remote Configuration', and 'Statistics'. The 'SMS Utilities' tab is active, showing a table of SMS Rules. The table has columns for Action, SMS Text, Enable, and Sort. There are four rows of rules: Reboot, Get status, Get I/O status, and Get OpenVPN status. Each row has an 'Enable' checkbox (checked) and a 'Sort' dropdown menu. To the right of each row are 'Edit' and 'Delete' buttons.

Action	SMS Text	Enable	Sort
Reboot	reboot	<input checked="" type="checkbox"/>	Sort dropdown
Get status	status	<input checked="" type="checkbox"/>	Sort dropdown
Get I/O status	iostatus	<input checked="" type="checkbox"/>	Sort dropdown
Get OpenVPN status	vpnstatus	<input checked="" type="checkbox"/>	Sort dropdown

All configuration options are listed below:

- Reboot
- Get status
- Get I/O status
- Switch output on / off
- Get OpenVPN status
- Switch WiFi on / off
- Switch mobile data on / off
- Change mobile data settings
- Get list of profiles
- Change profile
- Manage OpenVPN
- SSh access control
- Web access control
- Restore to default
- Force SIM switch
- GPS coordinates
- GPS on / off
- FW upgrade from server
- Config update from server
- Switch monitoring on / off
- Monitoring status

You can choose your SMS Keyword (text to be sent) and authorized phone number in the main menu. You can edit each created rule by hitting **Edit** button.

SMS Utilities | **Call Utilities** | **User Groups** | **SMS Management** | **Remote Configuration** | **Statistics**

SMS Configuration

Modify SMS Rule

Enable

Action:

SMS text:
SMS text, which let you reboot your router. E.g. "reboot"

Authorization method:

Allowed users:

Get status via SMS after reboot

Get information:

Message text:

	Field name	Explanation	Notes
1.	Reboot		
	Enable	This check box will enable and disable SMS reboot function.	Allows router restart via SMS.
	Action	The action to be performed when this rule is met.	
	SMS text	SMS text which will reboot router.	SMS text can contain letters, numbers, spaces and special symbols. Capital letters also matters.
	Authorization method	What kind of authorization to use for SIM management.	No authorization, by serial or by router admin password.
	Allowed users	Whitelist of allow users	From all numbers, from group or from single number.
	Get status via SMS after reboot	Check this to receive connection status via SMS after a reboot.	If you select this box, router will send status once it has rebooted and is operational again. This is both separate SMS Rule and an option under SMS Reboot rule.
	Message text	Which status information should be included in SMS: Data state, Operator, Connection type, Signal Strength, Connection State, IP	You can select which status elements to display.
2.	Get status		
	Enable	Check this to receive connection status via SMS.	Allows to get router's status via SMS. This is both separate SMS Rule and an option under SMS Reboot rule.
	Action	The action to be performed	

		when this rule is met.	
	Enable SMS Status	This check box will enable and disable SMS status function.	SMS status is disabled by default.
	SMS text	SMS text which will send routers status.	SMS text can contain letters, numbers, spaces and special symbols. Capital letters also matters.
	Authorization method	What kind of authorization to use for SIM management.	No authorization, by serial or by router admin password.
	Allowed users	Whitelist of allow users	From all numbers, from group or from single number.
	Message text	Which status information should be included in SMS: Data state, Operator, Connection type, Signal Strength, Connection State, IP	You can select which status elements to display.
3.	Get OpenVPN status		
	Enable	This check box will enable and disable this function.	Allows to get OpenVPN's status via SMS.
	Action	The action to be performed when this rule is met.	
	SMS text	SMS text which will send OpenVPN status.	SMS text can contain letters, numbers, spaces and special symbols. Capital letters also matters.
	Authorization method	What kind of authorization to use for SIM management.	No authorization, by serial or by router admin password.
	Allowed users	Whitelist of allow users	From all numbers, from group or from single number.
4.	Switch WiFi On/Off		
	Enable	This check box will enable and disable this function.	Allows Wi-Fi control via SMS.
	Action	The action to be performed when this rule is met.	Turn WiFi ON or OFF.
	SMS text	SMS text which will turn Wi-Fi ON/OFF.	SMS text can contain letters, numbers, spaces and special symbols. Capital letters also matters.
	Authorization method	What kind of authorization to use for SIM management.	No authorization, by serial or by router admin password.
	Allowed users	Whitelist of allow users	From all numbers, from group or from single number.
	Write to config	Permanently saves Wi-Fi state.	With this setting enabled, router will keep Wi-Fi state even after reboot. If it is not selected, router will revert Wi-Fi state after reboot.
5.	Switch mobile data on/off		
	Enable	This check box will enable and disable this function.	Allows mobile control via SMS.
	Action	The action to be performed when this rule is met.	Turn mobile ON or OFF.
	SMS text	SMS text which will turn mobile data ON/OFF.	SMS text can contain letters, numbers, spaces and special symbols. Capital letters also matters.
	Authorization method	What kind of authorization to use for SIM management.	No authorization, by serial or by router admin password.
	Allowed users	Whitelist of allow users	From all numbers, from group or from single number.
	Write to config	Permanently saves mobile network state.	With this setting enabled, router will keep mobile state even after reboot. If it is not selected, router will revert mobile state

			after reboot.
6.	Manage OpenVPN		
	Enable	This check box will enable and disable this function.	Allows OpenVPN control via SMS.
	Action	The action to be performed when this rule is met.	Turn OpenVPN ON or OFF.
	SMS text	Keyword which will turn OpenVPN ON/OFF.	SMS text can contain letters, numbers, spaces and special symbols. Capital letters also matters. After Keyword you have to write OpenVPN name.
	Authorization method	What kind of authorization to use for SIM management.	No authorization, by serial or by router admin password.
	Allowed users	Whitelist of allow users	From all numbers, from group or from single number.
7.	Change mobile data settings		
	Enable	This check box will enable and disable this function.	Allows to change mobile settings via SMS.
	Action	The action to be performed when this rule is met.	
	SMS text	Key word that will precede actual configuration parameters.	SMS text can contain letters, numbers, spaces and special symbols. Capital letters also matters.
	Authorization method	What kind of authorization to use for SIM management.	No authorization, by serial or by router admin password.
	Allowed users	Whitelist of allow users	From all numbers, from group or from single number.

Mobile Settings via SMS parameters:

	Parameter	Value(s)	Explanation
1.	apn=	e.g. internet.gprs	Sets APN. i.e: apn=internet.gprs
2.	dialnumber=	e.g. *99***1#	Sets dial number
3.	auth_mode=	none pap chap	Sets authentication mode
4.	service=	Auto 4gpreferred 4gonly 3gpreferred 3gonly 2gpreferred 2gonly	You can add as many phone numbers as you need. Dropdown list with additional rows will show up if you click on "add" icon at the end of phone number row.
5.	username=	user	Used only if PAP or CHAP authorization is selected
6.	password=	user	Used only if PAP or CHAP authorization is selected

All Mobile settings can be changed in one SMS. Between each <parameter=value> pair a space symbol is necessary.

Example: *cellular apn=internet.gprs dialnumber=*99***1#auth_mode=pap service=3gonly username=user password=user*

Important Notes:

- 3G settings must be configured correctly. If SIM card has PIN number you must enter it at "Network" > "3G" settings. Otherwise SMS reboot function will not work.

- Sender phone number must contain country code. You can check sender phone number format by reading the details of old SMS text messages you receiving usually.

	Field name	Explanation	Notes
8.	Get list of profiles		
	Enable	This check box will enable and disable this function.	Allows to get list of profiles via SMS.
	Action	The action to be performed when this rule is met.	
	SMS text	SMS text which will send list of profiles.	SMS text can contain letters, numbers, spaces and special symbols. Capital letters also matters.
	Authorization method	What kind of authorization to use for SIM management.	No authorization, by serial or by router admin password.
	Allowed users	Whitelist of allow users	From all numbers, from group or from single number.
9.	Change profile		
	Enable	This check box will enable and disable this function.	Allows profile change via SMS.
	Action	The action to be performed when this rule is met.	
	SMS text	Keyword which will change active profile.	SMS text can contain letters, numbers, spaces and special symbols. Capital letters also matters. After Keyword you have to write profile name.
	Authorization method	What kind of authorization to use for SIM management.	No authorization, by serial or by router admin password.
	Allowed users	Whitelist of allow users	From all numbers, from group or from single number.
10.	SSH access Control		
	Enable	This check box will enable and disable this function.	Allows SSH access control via SMS.
	Action	The action to be performed when this rule is met.	
	SMS text	SMS text which will turn SSH access ON/OFF.	SMS text can contain letters, numbers, spaces and special symbols. Capital letters also matters.
	Authorization method	What kind of authorization to use for SIM management.	No authorization, by serial or by router admin password.
	Allowed users	Whitelist of allow users	From all numbers, from group or from single number.
	Enable SSH access	Enable this to reach router via SSH from LAN (Local Area Network).	If this box is selected, SMS will enable SSH access from LAN. If this box is not selected, SMS will disable SSH access from LAN.
	Enable remote SSH access	Enable this to reach router via SSH from WAN (Wide Area Network).	If this box is selected, SMS will enable SSH access from WAN. If this box is not selected, SMS will disable SSH access from WAN.
11.	Web access Control		
	Enable	This check box will enable and disable this function.	Allows Web access control via SMS.
	Action	The action to be performed when this rule is met.	
	SMS text	SMS text which will turn Web access ON/OFF.	SMS text can contain letters, numbers, spaces and special symbols. Capital letters also matters.
	Authorization method	What kind of authorization to	No authorization, by serial or by router admin

		use for SIM management.	password.
	Allowed users	Whitelist of allow users	From all numbers, from group or from single number.
	Enable HTTP access	Enable this to reach router via HTTP from LAN (Local Area Network).	If this box is selected, SMS will enable HTTP access from LAN. If this box is not selected, SMS will disable HTTP access from LAN.
	Enable remote HTTP access	Enable this to reach router via HTTP from WAN (Wide Area Network).	If this box is selected, SMS will enable HTTP access from WAN. If this box is not selected, SMS will disable HTTP access from WAN.
	Enable remote HTTPS access	Enable this to reach router via HTTPS from WAN (Wide Area Network).	If this box is selected, SMS will enable HTTPS access from WAN. If this box is not selected, SMS will disable HTTPS access from WAN.
12.	Restore to default		
	Enable	This check box will enable and disable this function.	Allows to restore router to default settings via SMS.
	Action	The action to be performed when this rule is met.	Router will reboot after this rule is executed.
	SMS text	SMS text which will turn Wi-Fi ON/OFF.	SMS text can contain letters, numbers, spaces and special symbols. Capital letters also matters.
	Authorization method	What kind of authorization to use for SIM management.	No authorization, by serial or by router admin password.
	Allowed users	Whitelist of allow users	From all numbers, from group or from single number.
13.	Force switch SIM		
	Enable	This check box will enable and disable this function.	Allows SIM switch via SMS.
	Action	The action to be performed when this rule is met.	
	SMS text	SMS text which will change active SIM card to another one.	SMS text can contain letters, numbers, spaces and special symbols. Capital letters also matters.
	Authorization method	What kind of authorization to use for SIM management.	No authorization, by serial or by router admin password.
	Allowed users	Whitelist of allow users	From all numbers, from group or from single number.
	Sender phone number	Phone number of person who can receive router status via SMS message.	You can add as many phone numbers as you need. Dropdown list with additional rows will show up if you click on "add" icon at the end of phone number row.
14.	Force FW upgrade from server		
	Enable	This check box will enable and disable this function.	Allows to upgrade router's FW via SMS.
	Action	The action to be performed when this rule is met.	Router will reboot after this rule is executed.
	SMS text	SMS text which will force router to upgrade firmware from server.	SMS text can contain letters, numbers, spaces and special symbols. Capital letters also matters.
	Authorization method	What kind of authorization to use for SIM management.	No authorization, by serial or by router admin password.
	Allowed users	Whitelist of allow users	From all numbers, from group or from single number.
15.	Force Config update from server		
	Enable	This check box will enable and disable this function.	Allows to upgrade router's Config via SMS.
	Action	The action to be performed when this rule is met.	Router will reboot after this rule is executed.

	SMS text	SMS text which will force router to upgrade configuration from server.	SMS text can contain letters, numbers, spaces and special symbols. Capital letters also matters.
	Authorization method	What kind of authorization to use for SIM management.	No authorization, by serial or by router admin password.
	Allowed users	Whitelist of allow users	From all numbers, from group or from single number.
16.	Switch monitoring on/off		
	Enable	This check box will enable and disable this function.	Allows monitoring control via SMS.
	Action	The action to be performed when this rule is met.	Turn monitoring ON or OFF.
	SMS text	SMS text which will turn monitoring ON/OFF	SMS text can contain letters, numbers, spaces and special symbols. Capital letters also matters.
	Authorization method	What kind of authorization to use for SIM management.	By serial or by router admin password.
	Allowed users	Whitelist of allow users	From all uers, from group or from single number.
17.	Get I/O status		
	Enable	This check box will enable and disable this function.	Allows get I/O status via SMS.
	Action	The action to be performed when this rule is met.	
	SMS text	SMS text which let you get input/output status	SMS text can contain letters, numbers, spaces and special symbols. Capital letters also matters.
	Authorization method	What kind of authorization to use for SIM management.	By serial or by router admin password.
	Allowed users	Whitelist of allow users	From all uers, from group or from single number.
18.	Switch output on / off		
	Enable	This check box will enable and disable this function.	Allows output control via SMS.
	Action	The action to be performed when this rule is met.	Turn output ON or OFF.
	Active timeout	Rule active for a specific time, format seconds	
	SMS text	SMS text which let you manage your router output by your selected settings	SMS text can contain letters, numbers, spaces and special symbols. Capital letters also matters.
	Authorization method	What kind of authorization to use for SIM management.	By serial or by router admin password.
	Allowed users	Whitelist of allow users	From all uers, from group or from single number.
	Output type	Type of the output (Digital OC output or Relay output) which will be activated	
19.	GPS coordinates		
	Enable	This check box will enable and disable this function.	Allows get GPS coordinates via SMS.
	Action	The action to be performed when this rule is met.	
	SMS text	SMS text which let you to get your router GPS coordinates	SMS text can contain letters, numbers, spaces and special symbols. Capital letters also matters.
	Authorization method	What kind of authorization to use for SIM management.	By serial or by router admin password.
	Allowed users	Whitelist of allow users	From all uers, from group or from single number.
20.	GPS		
	Enable	This check box will enable and	Allows control GPS via SMS.

		disable this function.	
	Action	The action to be performed when this rule is met.	Turn GPS ON or OFF.
	SMS text	SMS text which let you to turn on or turn off your	SMS text can contain letters, numbers, spaces and special symbols. Capital letters also matters.
	Authorization method	What kind of authorization to use for SIM management.	By serial or by router admin password.
	Allowed users	Whitelist of allow users	From all uers, from group or from single number.

Important Notes:

- Mobile settings must be configured correctly. If SIM card has PIN number you must enter it at “Network” > “3G” settings. Otherwise SMS reboot function will not work.
- Sender phone number must contain country code. You can check sender phone number format by reading the details of old SMS text messages you receiving usually.

9.8.2 Call Utilities

Allow users to call to the router in order to perform one of the actions: Reboot, Get Status, turn Wi-Fi ON/OFF, turn Mobile data ON/OFF. Only thing that is needed is to call routers SIM card number from allowed phone (user) and RUT9 will perform all actions that are assigned for this particular number. To configure new action on call rules you just need to click the Add button in the „New Call rule” section. After that, you get in to the “Modify Call Rule section”.

Modify Call Rule

Enable

Action ▼

Allowed users ▼

Get status via SMS after reboot

	Field name	Sample	Explanation
1.	Enable	Enable/Disable	Enables the rule
2.	Action	Reboot	Action to be taken after receiving a call, you can choose from following actions: Reboot, Send status, Switch Wi-Fi, Switch mobile data.
3.	Allowed users	From all numbers	Allows to limit action triggering from all users, to user groups or single user numbers
4.	Get status via SMS after reboot	Enable/Disable	Enables automatic message sending with router status information after reboot

9.8.2.1 Incoming Calls

Incoming Calls

Reject unrecognized incoming calls

	Field name	Sample	Explanation
1.	Reject unrecognized incoming calls	Enable/Disable	If a call is made from number that is not in the active rule list, it can be rejected with this option

9.8.3 User Groups

Give possibility to group phone numbers for SMS management purposes. You can then later use these groups in all related SMS functionalities. This option helps if there are several Users who should have same roles when managing router via SMS. You can create new user group by entering group name and clicking on Add button in “Create New User Group” section. After that you get to “Modify User Group” section.

Modify User Group

Group name

Phone number

	Field name	Sample	Explanation
1.	Group name	Group1	Name of grouped phone numbers
2.	Phone number	+37061111111	Number to add to users group, must match international format. You can add phone numbers fields by clicking on the green + symbol

9.8.4 SMS Management

9.8.4.1 Read SMS

In SMS Management page Read SMS you can read and delete received/stored SMS.

SMS Utilities	Call Utilities	User Groups	SMS Management	Remote Configuration	Statistics
---------------	----------------	-------------	-----------------------	----------------------	------------

Read SMS	Send SMS	Storage
-----------------	----------	---------

SMS Messages

SMS per page: 10 Search:

Date	Sender	Message	
2016-05-05 13:51:56	+370612345678	Labas	<input type="checkbox"/>

Showing 1 to 1 of 1 entries

9.8.4.2 Send SMS

Read SMS	Send SMS	Storage
----------	-----------------	---------

Send SMS

Send SMS Message

Phone Number:

Message:

SMS 1 (152 characters left)

	Field name	Sample	Explanation
1.	Phone number	+3701111111	Recipients phone number. Should be preceded with country code, i.e. "+370"
2.	Message	My text.	Message text, special characters are allowed.

9.8.4.3 Storage

With **storage** option you can choose for router NOT to delete SMS from SIM card. If this option is not used, router will automatically delete all incoming messages after they have been read. Message status "read/unread" is examined every 60 seconds. All "read" messages are deleted.

Read SMS Send SMS Storage

SMS Storing

Configuration

Save messages on SIM

SIM card memory Used:0 Available: 50

Leave free space

Save

	Field name	Sample	Explanation
1.	Save messages on SIM	Enabled / Disabled	Enables received message storing on SIM card
2.	SIM card memory	Used: 0 Available: 50	Information about used/available SIM card memory
3.	Leave free space	1	How much memory (number of message should be left free

9.8.5 Remote Configuration

RUT9xx can be configured via SMS from another RUT9xx. You only have to select which configuration details have to be sent, generate the SMS Text, type in the phone number and Serial number of the router that you wish to configure and Send the SMS.

Total count of SMS is managed automatically. You should be aware of possible number of SMS and use this feature at your own responsibility. It should not, generally, be used if you have high cost per SMS. This is especially relevant if you will try to send whole OpenVPN configuration, which might acumulate ~40 SMS.

9.8.5.1 Receive configuration

This section controls how configuration initiation party should identify itself. In this scenario RUT955 itself is being configured.

Recieve Configuration

Receive Configuration

Enable

Authorization method

Allowed users

Field name	Values	Notes
------------	--------	-------

1.	Enable	Enabled / Disabled	Enables router to receive configuration
1.	Authorization method	No authorization / By serial By administration password	Describes what kind of authorization to use for SMS management. Method at Receiving and Sending ends must match
2.	Allowed users	From all numbers From group From single number	Gives greater control and security measures

Note, that for safety reasons Authorization method should be configured before deployment of the router.

9.8.5.2 Send configuration

This section lets you configure remote RUT955 devices. The authorization settings must confirm to those that are set on the receiving party.

Send Configuration

Configuration Message

Network

VPN

Generate SMS New

WAN

Interface Mobile

Primary SIM card SIM1

Mobile connection Use pppd mode

APN internet.mnc012.mcc34c

Dialing number +37060000001

Authentication method CHAP

User name admin

Password ••••••

Service mode 3G preferred

LAN

IP address 192.168.1.1

IP netmask 255.255.255.0

IP broadcast 192.168.1.255

Field name	Values	Notes
------------	--------	-------

1.	Generate SMS	New/From current configuration	Generate new SMS settings or use current device configuration
2.	Interface	Mobile/Wired	Interface type used for WAN (Wide Area Network) connection
3.	WAN	Enable/Disable	Include configuration for WAN (Wide Area Network)
4.	LAN	Enable/Disable	Include configuration for LAN (Local Area Network)
6.	Protocol	Static/DHCP	Network protocol used for network configuration parameters management
7.	IP address	"217.147.40.44"	IP address that router will use to connect to the internet
8.	IP netmask	"255.255.255.0"	That will be used to define how large the WAN (Wide Area Network) network is
11.	IP gateway	"217.147.40.44"	The address where traffic destined for the internet is routed to
12.	IP broadcast	"217.147.40.255"	A logical address at which all devices connected to a multiple-access communications network are enabled to receive datagrams.
13.	Primary SIM card	SIM1/SIM2	A SIM card that will be used as primary
14.	Mobile connection	Use pppd mode Use ndis mode	An underlying agent that will be used for mobile data connection creation and management
15.	APN	"internet.mnc012.mcc345.gprs"	(APN) is the name of a gateway between a GPRS or 3G mobile networks and another computer network, frequently the public Internet.
16.	Dialing number	"+37060000001"	A phone number that will be used to establish a mobile PPP (Point-to-Point Protocol) connection
17.	Authentication method	CHAP/PAP/None	Select an authentication method that will be used to authenticate new connections on your GSM carrier's network
18.	User name	"admin"	User name used for authentication on your GSM carrier's network
19.	Password	"password"	Password used for authentication on your GSM carrier's network
20.	Service mode	Auto 4G (LTE) preferred 4G (LTE) only 3G preferred 3G only 2G preferred 2G only	You can add as many phone numbers as you need. Dropdown list with additional rows will show up if you click on "add" icon at the end of phone number row.
21.	IP address	"192.168.1.1"	IP address that router will use on LAN (Local Area Network) network
22.	IP netmask	"255.255.255.0"	A subnet mask that will be used to define how large the LAN (Local Area Network) network is
23.	IP broadcast	"192.168.1.255"	A logical address at which all devices connected to a multiple-access communications network are enabled to receive datagrams

Send Configuration Message

```
network.wan.ifname=eth1, network.ppp.enabled=0, network.wan.proto=static,
network.wan.ipaddr=217.147.40.44, network.wan.netmask=255.255.255.0,
network.wan.gateway=217.147.40.44, network.wan.broadcast=217.147.40.255
```

Phone number

Authorization method

	Field name	Values	Notes
1.	Message text field	Generated configuration message	Here you can review and modify configuration message text to be sent
2.	Phone number	"+37060000001"	A phone number of router which will receive the configuration
3.	Authorization method	No authorization By serial By router admin password	What kind of authorization to use for remote configuration

9.8.6 Statistics

In statistics page you can review how much SMS was sent and received on both SIM card slots. You can also reset the counters.

SMS Utilities	Call Utilities	User Groups	SMS Management	Remote Configuration	Statistics
Statistics					
SMS Statistics					
SIM Card	Sent SMS	Received SMS			
SIM 1	0	0		<input type="button" value="Reset"/>	
SIM 2	0	0		<input type="button" value="Reset"/>	

9.9 SNMP

SNMP settings window allows you to remotely monitor and send GSM event information to the server.

9.9.1 SNMP Settings

SNMP Service Settings

Enable SNMP service

Enable remote access

Port

Community

Location

Contact

Name

	Field name	Sample	Explanation
1.	Enable SNMP service	Enable/Disable	Run SNMP (Simple Network Management Protocol) service on system's start up
2.	Enable remote access	Enable/Disable	Open port in firewall so that SNMP (Simple Network Management Protocol) service may be reached from WAN
3.	Port	161	SNMP (Simple Network Management Protocol) service's port
4.	Community	Public/Private/Custom	The SNMP (Simple Network Management Protocol) Community is an ID that allows access to a router's SNMP data
5.	Community name	custom	Set custom name to access SNMP
6.	Location	Location	Trap named sysLocation
7.	Contact	email@example.com	Trap named sysContact
8.	Name	Name	Trap named sysName

Variables/OID

	OID	Description
1.	1.3.6.1.4.1.99999.1.1.1	Modem IMEI
2.	1.3.6.1.4.1.99999.1.1.2	Modem model
3.	1.3.6.1.4.1.99999.1.1.3	Modem manufacturer
4.	1.3.6.1.4.1.99999.1.1.4	Modem revision
5.	1.3.6.1.4.1.99999.1.1.5	Modem serial number
6.	1.3.6.1.4.1.99999.1.1.6	SIM status
7.	1.3.6.1.4.1.99999.1.1.7	Pin status
8.	1.3.6.1.4.1.99999.1.1.8	IMSI
9.	1.3.6.1.4.1.99999.1.1.9	Mobile network registration status
10.	1.3.6.1.4.1.99999.1.1.10	Signal level
11.	1.3.6.1.4.1.99999.1.1.11	Operator currently in use
12.	1.3.6.1.4.1.99999.1.1.12	Operator number (MCC+MNC)
13.	1.3.6.1.4.1.99999.1.1.13	Data session connection state
14.	1.3.6.1.4.1.99999.1.1.14	Data session connection type
15.	1.3.6.1.4.1.99999.1.1.15	Signal strength trap
16.	1.3.6.1.4.1.99999.1.1.16	Connection type trap

9.9.2 TRAP Settings

TRAP Service Settings

SNMP Trap

Host/IP

Port

Community

TRAP Rules

Action	Enable	
Connection type trap	<input checked="" type="checkbox"/>	<input type="button" value="Edit"/> <input type="button" value="Delete"/>
Signal strength trap	<input checked="" type="checkbox"/>	<input type="button" value="Edit"/> <input type="button" value="Delete"/>

New TRAP Rule

Action

	Field name	Sample	Explanation
1.	SNMP Trap	Enable/Disable	Enable SNMP (Simple Network Management Protocol) trap functionality
2.	Host/IP	192.168.99.155	Host to transfer SNMP (Simple Network Management Protocol) traffic to
3.	Port	162	Port for trap's host
4.	Community	Public/Private	The SNMP (Simple Network Management Protocol) Community is an ID that allows access to a router's SNMP data

9.10 SMS Gateway

9.10.1 Post/Get Configuration

Post/Get Configuration allows you to perform actions by writing these requests URI after your device IP address.

Post/Get
Email To SMS
Scheduled SMS
Auto Reply
SMS Forwarding
SMPP

Post/Get Configuration

SMS Post/Get Settings

Enable

User name

Password

	Field name	Values	Notes
1.	Enable	Enabled / Disabled	Enable SMS management functionality through POST/GET
2.	User name	admin	User name used for authorization
3.	Password	*****	Password used for authorization (default- admin01)

Do not forget to change parameters in the url according to your POST/GET Configuration!

9.10.1.1 SMS by HTTP POST/GET

It is possible to read and send SMS by using valid HTTP POST/GET syntax. Use web browser or any other compatible software to submit HTTP POST/GET string to router. Router must be connected to GSM network when using "SMS send" feature.

	Action	POST/GET url e.g.
1.	View mobile messages list	/cgi-bin/sms_list?username=admin&password=admin01
2.	Read mobile message	/cgi-bin/sms_read?username=admin&password=admin01&number=1
3.	Send mobile messages	/cgi-bin/sms_send?username=admin&password=admin01&number=0037060000001&text=testmessage
4.	View mobile messages total	/cgi-bin/sms_total?username=admin&password=admin01
5.	Delete mobile message	/cgi-bin/sms_delete?username=admin&password=admin01&number=1

9.10.1.2 Syntax of HTTP POST/GET string

HTTP POST/GET string	Explanation
http://{IP_ADDRESS}	
/cgi-bin/sms_read?username={your_user_name}&password={your_password}&number={MESSAGE_INDEX}	Read message
/cgi-bin/sms_send?username={your_user_name}&password={your_password}&number={PHONE_NUMBER}&text={MESSAGE_TEXT}	Send message
/cgi-bin/sms_delete?username={your_user_name}&password={your_password}&number={MESSAGE_INDEX}	Delete message
/cgi-bin/sms_list?username={your_user_name}&password={your_password}	List all messages
/cgi-bin/sms_total?username={your_user_name}&password={your_password}	Number of messages in memory

Note: parameters of HTTP POST/GET string are in capital letters inside curly brackets. Curly brackets (“{ }”) are not needed when submitting HTTP POST/GET string.

9.10.1.3 Parameters of HTTP POST/GET string

	Parameter	Explanation
1.	IP_ADDRESS	IP address of your router
2.	MESSAGE_INDEX	SMS index in memory
3.	PHONE_NUMBER	Phone number of the message receiver. Note: Phone number must contain country code. Phone number format is: 00{COUNTRY_CODE} {RECEIVER_NUMBER}. E.g.: 0037062312345 (370 is country code and 62312345 is receiver phone number)
4.	MESSAGE_TEXT	Text of SMS. Note: Maximum number of characters per SMS is 160. You cannot send longer messages. It is suggested to use alphanumeric characters only.

After every executed command router will respond with return status.

9.10.1.4 Possible responses after command execution

	Response	Explanation
1.	OK	Command executed successfully
2.	ERROR	An error occurred while executing command
3.	TIMEOUT	No response from the module received
4.	WRONG_NUMBER	SMS receiver number format is incorrect or SMS index number is incorrect
5.	NO MESSAGE	There is no message in memory by given index
6.	NO MESSAGES	There are no stored messages in memory

9.10.1.5 HTTP POST/GET string examples

http://192.168.1.1/cgi-bin/sms_read?username=admin&password=admin01&number=2

http://192.168.1.1/cgi-bin/sms_send?username=admin&password=admin01&number=0037060000001&text=message

http://192.168.1.1/cgi-bin/sms_delete?username=admin&password=admin01&number=4

http://192.168.1.1/cgi-bin/sms_list?username=admin&password=admin01

http://192.168.1.1/cgi-bin/sms_total?username=admin&password=admin01

9.10.2 Email to SMS

Post/Get	Email To SMS	Scheduled SMS	Auto Reply	SMS Forwarding	SMPP
POP3 Email To SMS Configuration					
Email To SMS Settings					
Enable <input type="checkbox"/>					
POP3 server <input type="text" value="pop.gmail.com"/>					
Server port <input type="text" value="995"/>					
User name <input type="text" value="admin"/>					
Password <input type="text" value="admin01"/> 					
Secure connection (SSL) <input type="checkbox"/>					
Check email every <input type="text" value="1"/> <input type="text" value="Minutes"/>					
<input type="button" value="Save"/>					

	Field name	Values	Notes
1.	Enable	Enable/Disable	Allows to convert received Email to SMS
2.	POP3 server	"pop.gmail.com"	POP3 server address
3.	Server port	"995"	Server authentication port
4.	User name	"admin"	User name using for server authentication
5.	Password	"admin01"	Password using for server authentication
6.	Secure connection (SLL)	Enable/Disable	(SSL) is a protocol for transmitting private documents via the Internet. SSL uses a cryptographic system that uses two keys to encrypt data – a public key known to everyone and a private or secret key known only to the recipient of the message.
7.	Check mail every	Minutes Hours Days	Mail checking period

9.10.3 Scheduled Messages

Scheduled messages allow to periodically sending mobile messages to specified number.

9.10.3.1 Scheduled Messages Configuration

Modify scheduled message

Enable

Recipient's phone number

Message text

SMS 1 (156 characters left)

Message sending Interval

Hour

Minute

	Field name	Values	Notes
1.	Enable	Enable/Disable	Activates periodical messages sending.
2.	Recipient's phone number	"+37060000001"	Phone number that will receive messages.
3.	Message text	"Test"	Message that will be send.
4.	Message sending interval	Day/Week/Month/Year	Message sending period.

9.10.4 Auto Reply Configuration

Auto reply allows replying to every message that router receives to everyone or to listed numbers only.

Reply Configuration

Enable

Don't save received message

Mode

Message

	Field name	Values	Notes
1.	Enable	Enable/Disable	Enable auto reply to every received mobile message.
2.	Don't save received message	Enable/Disable	If enabled, received messages are not going to be saved
3.	Mode	Everyone / Listed numbers	Specifies from which senders received messages are going to be replied.
4.	Message	"Text"	Message text that will be sent in reply.

9.10.5 SMS Forwarding

9.10.5.1 SMS Forwarding To HTTP

This functionality forwards mobile messages from all or only specified senders to HTTP, using either POST or GET methods.

SMS Forwarding To HTTP
SMS Forwarding To SMS
SMS Forwarding To Email

SMS Forwarding To HTTP Configuration

SMS Forwarding To HTTP Settings

Enable

Method

URL

Number value name

Message value name

Extra data pair 1

Extra data pair 2

Mode

Field name	Values	Notes
------------	--------	-------

1.	Enable	Enable / Disable	Enable mobile message forwarding to HTTP
2.	Method	POST / GET	Defines the HTTP transfer method
3.	URL	192.168.99.250/getpost/index.php	URL address to forward messages to
4.	Number value name	“sender”	Name to assign for sender’s phone number value in query string
5.	Message value name	“text”	Name to assign for message text value in query string
6.	Extra data pair 1	Var1 - 17	If you want to transfer some extra information through HTTP query, enter variable name on the left field and its value on the right
7.	Extra data pair 2	Var2 – “go”	If you want to transfer some extra information through HTTP query, enter variable name on the left field and its value on the right
8.	Mode	All messages/From listed numbers	Specifies which senders messages to forward

9.10.5.2 SMS Forwarding to SMS

This functionality allows forwarding mobile messages from specified senders to one or several recipients.

SMS Forwarding To SMS Configuration

SMS Forwarding To SMS Settings

Enable

Add sender number

Mode All messages ▼

recipients phone numbers +37060000001 +

	Field name	Values	Notes
1.	Enable	Enable / Disable	Enable mobile message forwarding
2.	Add sender number	Enable / Disable	If enabled, original senders number will be added at the end of the forwarded message
3.	Mode	All message / From listed numbers	Specifies from which senders received messages are going to be forwarded.
4.	Recipients phone numbers	+37060000001	Phone numbers to which message is going to be forwarded to

9.10.5.3 SMS Forwarding to Email

This functionality forwards mobile messages from one or several specified senders to email address.

SMS Forwarding To Email Configuration

SMS Forwarding To Email Settings

Enable

Add sender's number

Subject

SMTP server

SMTP server port

Secure connection

User name

Password 

Sender's email address

Recipient's email address 

Mode 

	Field name	Values	Notes
1.	Enable	Enable / Disable	Enable mobile message forwarding to email
2.	Add sender number	Enable / Disable	If enabled, original senders number will be added at the end of the forwarded message
3.	Subject	"forwarded message"	Text that will be inserted in email Subject field
4.	SMTP server	mail.teltonika.it	Your SMTP server's address
5.	SMTP server port	25	Your SMTP server's port number
6.	Secure connection	Enable / Disable	Enables the use of cryptographic protocols, enable only if your SMTP server supports SSL or TLS
7.	User name	"admin"	Your full email account user name
8.	Password	*****	Your email account password
9.	Sender's email address	name.surname@gmail.com	Your address that will be used to send emails from
10.	Recipient's email address	name2.surname2@gmail.com	Address that you want to forward your messages to
11.	Mode	All messages / from listed numbers	Choose which senders messages to forward to email

9.10.6 SMPP

Post/Get	Email To SMS	Scheduled SMS	Auto Reply	SMS Forwarding	SMPP
SMPP Server Configuration					
Transmitter Configuration					
Enable <input type="checkbox"/>					
User name <input type="text" value="admin"/>					
Password <input type="password" value="••••••••"/> 					
Server port <input type="text" value="7777"/>					

	Field name	Values	Explanation
1.	Enable	Enable/Disable	Enables SMPP server
2.	User name	admin	User name for authentication on SMPP server
3.	Password	••••••••	Password for authentication on SMPP server
4.	Server port	7777	A port will be used for SMPP server communications. Allowed all not used ports [0-65535]

9.11 GPS

9.11.1 GPS

On this page you can view your current coordinates and position on map

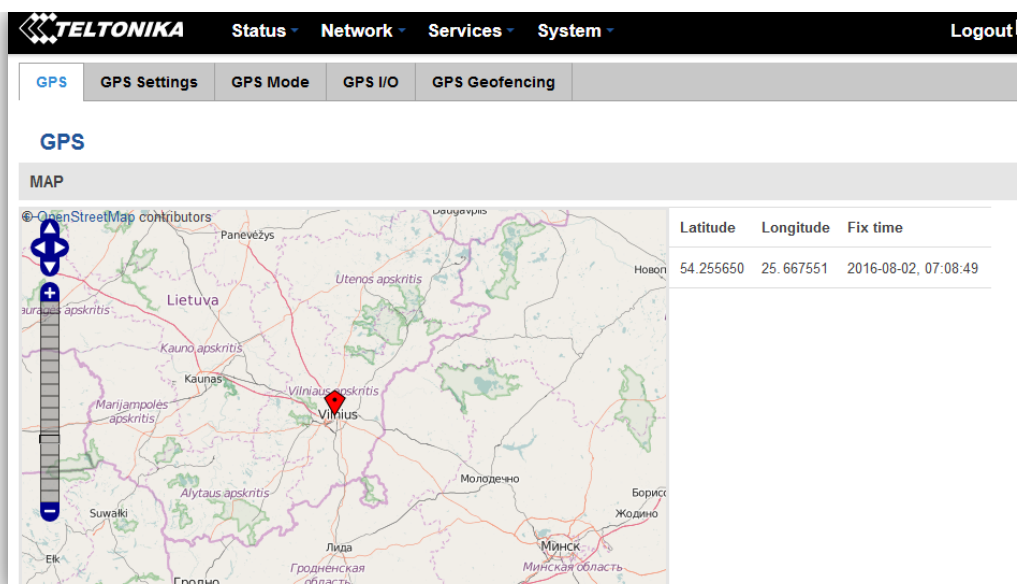

The screenshot shows the TELTONIKA web interface with the following elements:

- Navigation menu: Status, Network, Services, System, Logout
- Sub-menu: GPS, GPS Settings, GPS Mode, GPS I/O, GPS Geofencing
- Section: GPS
- MAP: A map showing the current location in Lithuania, near Vilnius.
- Table of coordinates:

Latitude	Longitude	Fix time
54.255650	25.667551	2016-08-02, 07:08:49

9.11.2 GPS Settings

This is the GPS parameters configuration page.

	Field name	Values	Notes
1.	Enable GPS service	Enable / Disable	By enabling it will start generate your location coordinates
2.	Enable GPS Data to server	Enable / Disable	By enabling it will start generate your location coordinates and transfer them to specified server
3.	Remote host / IP address	212.47.99.61	Server IP address or domain name to send coordinates to
4.	Port	17050	Server port used for data transfer
5.	Protocol	TCP or UDP	Protocol to be used for coordinates data transfer to server

9.11.3 GPS Mode

Data sending

	Field name	Values	Notes
1.	Min period	5	Period (in seconds) for data collection
2.	Min distance	200	Distance difference (in meters) between last registered and current coordinates to collect data (even if Min period have not passed yet)
3.	Min angle	30	Minimal angle difference between last registered and current coordinates to collect data (even if Min period have not passed yet)
4.	Min saved records	20	Minimal amount of coordinates registered, to send them to server immediately (even if Send period have not passed yet)
5.	Send period	50	Period for sending collected data to server

Rules

This table shows created GPS rules for data sending.

GPS Configuration

GPS configuration section allows to save several different configurations for GPS data collection, active configuration is automatically selected when configured conditions are met.

	Field name	Values	Notes
1.	WAN	Mobile/ Wired/ WiFi	Interface which needs to be used to activate this configuration
2.	Type	Home/ Roaming/ Both	Mobile connection state needed to activate this configuration
3.	Digital Isolated Input	Low logic level/ High logic level/ Both	Input state needed to activate this configuration

9.11.4 GPS I/O

Check Analog

	Field name	Values	Notes
1.	Interval (sec)	5	Interval to check analog input value

Input Rules

In this table shows created Input rules.

GPS Input Configuration

	Field name	Values	Notes
1.	Input Type	Digital/ Digital isolated/ Analog	Select type on your own intended configuration
2.	Trigger	Input open/ Input shorted/ Both	Select trigger event for your own intended configuration
3.	Priority	Low/ High/ Panic	Different priority settings ads different priority flags to event packet, and they can be displayed differently

9.11.5 GPS Geofencing

Geofencing is a feature which can detect whenever a device enters or leaves customized area.

	Field name	Notes
1.	Enable	Enable/Disable GPS Geofencing functionality
2.	Longitude (X)	Longitude of selected point
3.	Latitude (Y)	Latitude of selected point
4.	Radius	Radius of selected area
5.	Get current coordinates	Get current device coordinates from GPS

To receive SMS or email when entering or leaving geofence zone, go to Status -> Events Log -> Events reporting page and configure GPS event type!

9.12 Hotspot

Wireless hotspot provides essential functionality for managing an open access wireless network. In addition to standard RADIUS server authentication there is also the ability to gather and upload detailed logs on what each device (denoted as a MAC address) was doing on the network (what sites were traversed, etc.).

9.12.1 General settings

9.12.1.1 Main settings

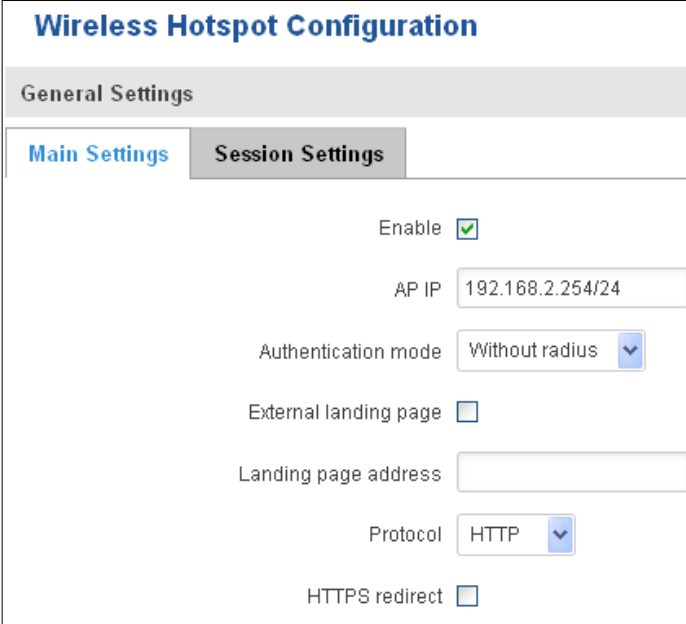

The screenshot displays the 'Wireless Hotspot Configuration' interface. It features a 'General Settings' section with two tabs: 'Main Settings' (selected) and 'Session Settings'. The 'Main Settings' tab contains the following configuration options:

- Enable:** A checked checkbox.
- AP IP:** A text input field containing '192.168.2.254/24'.
- Authentication mode:** A dropdown menu set to 'Without radius'.
- External landing page:** An unchecked checkbox.
- Landing page address:** An empty text input field.
- Protocol:** A dropdown menu set to 'HTTP'.
- HTTPS redirect:** An unchecked checkbox.

Users Configuration					
User name	Password	Idle timeout	Session timeout	Download bandwidth	Upload bandwidth
<i>There are no users created yet.</i>					
Username		Password			
<input type="text"/>		<input type="text"/>			
		<input type="button" value="Add"/>			

	Field name	Explanation
1.	Enabled	Check this flag to enable hotspot functionality on the router.
2.	AP IP	Access Point IP address. This will be the address of the router on the hotspot network. The router will automatically create a network according to its own IP and the CIDR number that you specify after the slash. E.g. "192.168.2.254/24" means that the router will create a network with the IP address 192.168.182.0, netmask 255.255.255.0 for the express purpose of containing all the wireless clients. Such a network will be able to have 253 clients (their IP addresses will be automatically granted to them and will range from 192.168.2.1 to 192.168.2.253).

Authentication mode: External radius

1.	Radius server #1	The IP address of the RADIUS server that is to be used for Authenticating your wireless clients.
2.	Radius server #2	The IP address of the second RADIUS server.
3.	Authentication port	RADIUS server authentication port.
4.	Accounting port	RADIUS server accounting port.
5.	Radius secret key	The secret key is used for authentication with the RADIUS server
6.	UAM port	Port to bind for authenticating clients
7.	UAM UI port	UAM UI port
8.	UAM secret	Shared secret between UAM server an hotspot
9.	NAS Identifier	NAS Identifier
10.	Swap octets	Swap the meaning of input octets and output as it related to RADIUS attributes
11.	Location name	The name of location

Authentication mode: Internal radius/Without radius

1.	External landing page	Enables the use of external landing page.
2.	Landing page address	The address of external landing page
3.	HTTPS redirect	Redirects HTTP pages to landing page.

Authentication mode: SMS OTP

9.12.1.2 Session settings

Wireless Hotspot Configuration

General Settings

Main Settings

Session Settings

Logout address

List Of Addresses The Client Can Access Without First Authenticating

Enable	Address	Port	Allow subdomains	
<input type="checkbox"/>	<input style="width: 100%;" type="text"/>	<input style="width: 100%;" type="text"/>	<input type="checkbox"/>	<input type="button" value="Delete"/>

	Field name	Explanation
1.	Logout address	IP address to instantly logout a client addressing it
2.	Enable	Enable address accessing without first authenticating
3.	Address	Domain name, IP address or network segment
4.	Port	Port number
5.	Allow subdomains	Enable/Disable subdomains

9.12.2 Internet Access Restriction Settings

Allows disable internet access on specified day and hour of every week.

General

Restricted Internet Access

Logging

Landing Page

Radius Server

Teltonika_Router

Internet Access Restriction Settings

Select Time To Restrict Access On Hotspot Teltonika_Router

Days/Hours	0-1h	1-2h	2-3h	3-4h	4-5h	5-6h	6-7h	7-8h	8-9h	9-10h	10-11h	11-12h	12-13h	13-14h	14-15h	15-16h	16-17h	17-18h	18-19h	19-20h	20-21h	21-22h	22-23h	23-24h
Monday																								
Tuesday																								
Wednesday																								
Thursday																								
Friday																								
Saturday																								
Sunday																								

Internet access allowed
 Internet access blocked

9.12.3 Logging

9.12.3.1 Configuration

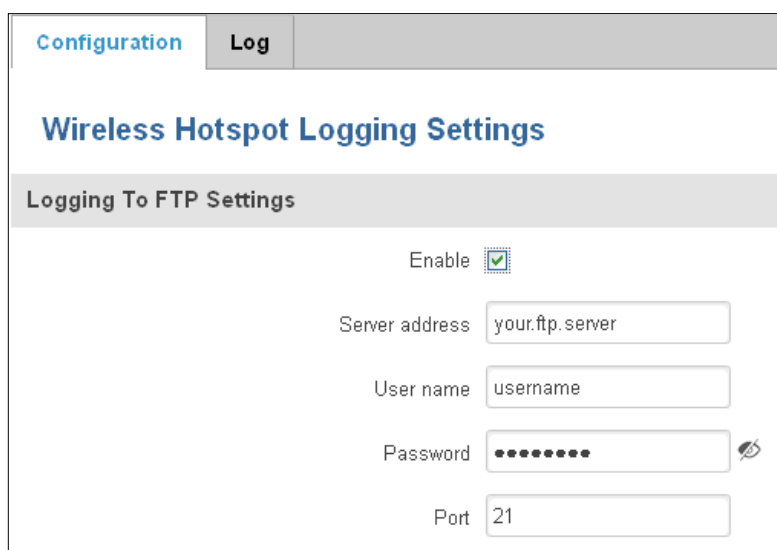

Configuration Log

Wireless Hotspot Logging Settings

Logging To FTP Settings

Enable

Server address

User name

Password 

Port

	Field name	Explanation
1.	Enable	Check this box if you want to enable wireless traffic logging. This feature will produce logs which contain data on what websites each client was visiting during the time he was connected to your hotspot.
2.	Server address	The IP address of the FTP server to which you want the logs uploaded.
3.	Username	The username of the user on the aforementioned FTP server.
4.	Password	The password of the user.
5.	Port	The TCP/IP Port of the FTP server.

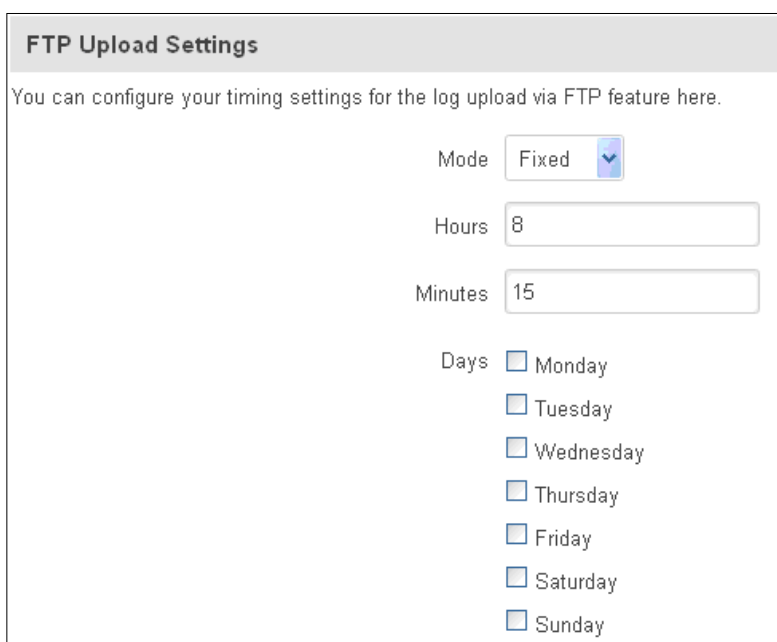

FTP Upload Settings

You can configure your timing settings for the log upload via FTP feature here.

Mode 

Hours

Minutes

Days Monday
 Tuesday
 Wednesday
 Thursday
 Friday
 Saturday
 Sunday

	Field name	Explanation
1.	Mode	The mode of the schedule. Use "Fixed" if you want the uploading to be done on a specific time of the day. Use "Interval" if you want the uploading to be done at fixed interval.

2.	Interval	Shows up only when “Mode” is set to Interval. Specifies the interval of regular uploads on one specific day. E.g. If you choose 4 hours, the uploading will be done on midnight, 4:00, 8:00, 12:00, 16:00 and 20:00.
3.	Days	Uploading will be performed on these days only
4.	Hours, Minutes	Shows up only when “Mode” is set to Fixed. Uploading will be done on that specific time of the day. E.g. If you want to upload your logs on 6:48 you will have to simply enter hours: 6 and minutes: 48.

9.12.3.2 Log

Configuration

Log

Wifi Log

Events per page ▼
Search

MAC ↕	IP ↕	Port ↕	Date ↕	Time ↕
<i>There are no records yet.</i>				

Showing 1 to 1 of 1 entries

9.12.4 Landing Page

9.12.4.1 General Landing Page Settings

With this functionality you can customize your Hotspot Landing page.

General
Template

Wireless Hotspot Landing Settings

Landing Page Settings

Page title

Teltonika Hotspot

Theme

Custom ▼

Upload login page

Browse...

No file selected.

Login page file

Download

Demo preview

▾ Terms Of Services

▾ Background Configuration

▾ Logo Image Configuration

▾ Link Configuration

▾ Text Configuration

	Field name	Explanation
1.	Page title	Will be seen as landing page title
2.	Theme	Landing page theme selection
3.	Upload login page	Allows to upload custom landing page theme
4.	Login page file	Allows to download and save your landing page file

In the sections – “Terms Of Services”, “Background Configuration”, “Logo Image Configuration”, “Link Configuration”, “Text Configuration” you can customize various parameters of landing page components.

9.12.4.2 Template

In this page you can review landing page template HTML code and modify it.

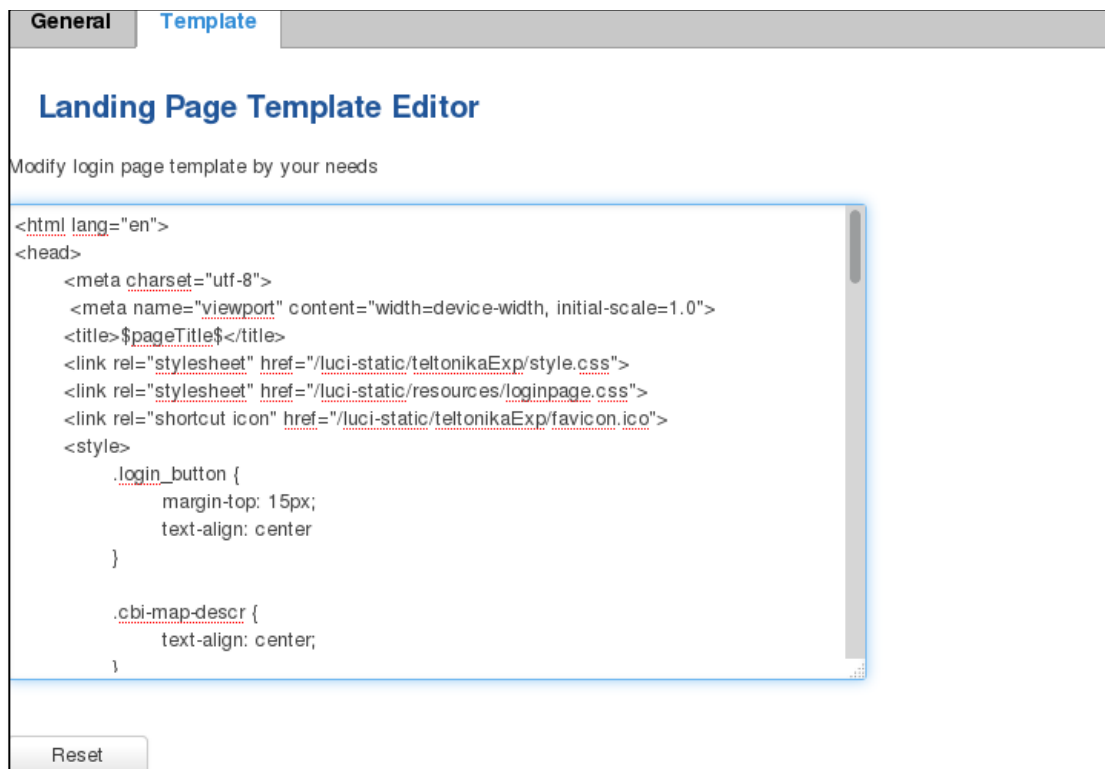

The screenshot shows the 'Landing Page Template Editor' interface. At the top, there are two tabs: 'General' and 'Template', with 'Template' selected. Below the tabs is the title 'Landing Page Template Editor' and a subtitle 'Modify login page template by your needs'. The main area is a text editor containing HTML code for the login page template. The code includes meta tags for charset, viewport, and title, as well as links to CSS and favicon files. There are also CSS style rules for the login button and a map description. A 'Reset' button is located at the bottom left of the editor area.

```
<html lang="en">
<head>
  <meta charset="utf-8">
  <meta name="viewport" content="width=device-width, initial-scale=1.0">
  <title>$pageTitle$</title>
  <link rel="stylesheet" href="/luci-static/teltonikaExp/style.css">
  <link rel="stylesheet" href="/luci-static/resources/loginpage.css">
  <link rel="shortcut icon" href="/luci-static/teltonikaExp/favicon.ico">
  <style>
    .login_button {
      margin-top: 15px;
      text-align: center;
    }

    .cbi-map-descr {
      text-align: center;
    }
  </style>
</head>
</html>
```

9.12.5 Radius server configuration

An authentication and accounting system used by many Internet Service Providers (ISPs). When you dial in to the ISP you must enter your username and password. This information is passed to a RADIUS server, which checks that the information is correct, and then authorizes access to the ISP system.

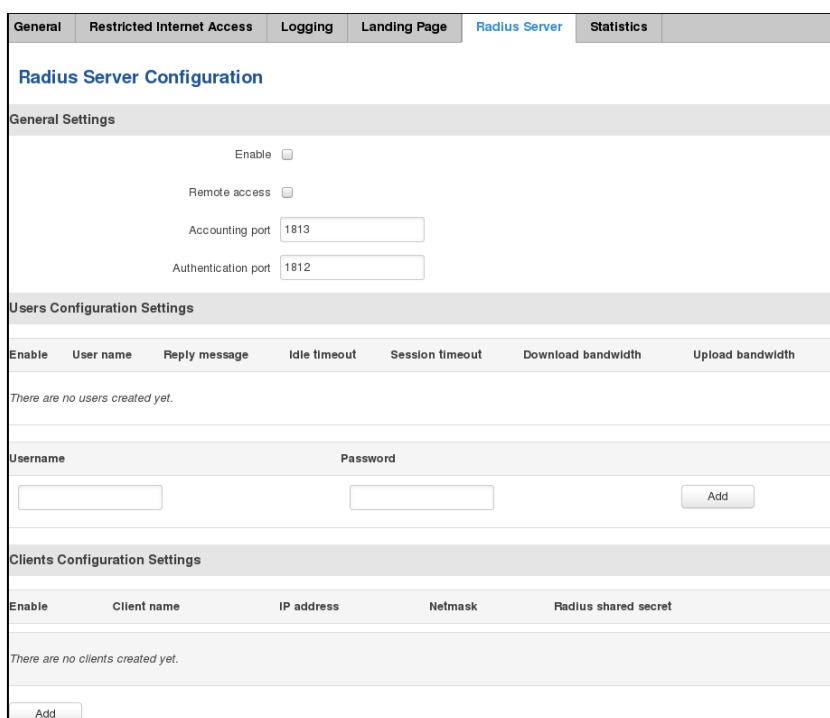

The screenshot shows the 'Radius Server Configuration' interface. At the top, there are several tabs: 'General', 'Restricted Internet Access', 'Logging', 'Landing Page', 'Radius Server', and 'Statistics', with 'Radius Server' selected. Below the tabs is the title 'Radius Server Configuration'. The interface is divided into several sections: 'General Settings' with 'Enable' and 'Remote access' checkboxes, and 'Accounting port' and 'Authentication port' input fields; 'Users Configuration Settings' with a table for user configuration and an 'Add' button; and 'Clients Configuration Settings' with a table for client configuration and an 'Add' button.

Enable	User name	Reply message	Idle timeout	Session timeout	Download bandwidth	Upload bandwidth
There are no users created yet.						

Enable	Client name	IP address	Netmask	Radius shared secret
There are no clients created yet.				

	Field name	Explanation
1.	Enable	Activates an authentication and accounting system
2.	Remote access	Activates remote access to radius server
3.	Accounting port	Port on which to listen for accounting
4.	Authentication port	Port on which to listen for authentication

9.12.6 Statistics

On hotspot statistics page you can review statistical information about hotspot instances.

9.13 CLI

CLI or Comand Line Interface functionality allows you to enter and execute comands into routers terminal.

9.14 Auto Reboot

9.14.1 Ping Reboot

Ping Reboot function will periodically send Ping command to server and waits for echo receive. If no echo is received router will try again sending Ping command defined number times, after defined time interval. If no echo is received after the defined number of unsuccessful retries, router will reboot. It is possible to turn of the router rebooting after defined unsuccessful retries. Therefore this feature can be used as “Keep Alive” function, when router pings the host unlimited number of times. Possible actions if no echo is received: Reboot, Modem restart, Restart mobile connection, (Re) register, None.

Ping Reboot

Ping Reboot Settings

Enable

Action if no echo is received Reboot

Interval between pings 5 mins

Ping timeout (sec) 5

Packet size 56

Retry count 2

Interface Ping from mobile

Host to ping from SIM 1 127.0.0.1

Host to ping from SIM 2 127.0.0.1

	Field name	Explanation	Notes
1.	Enable	This check box will enable or disable Ping reboot feature.	Ping Reboot is disabled by default.
2.	Action if no echo is received	Action after the defined number of unsuccessful retries	No echo reply for sent ICMP (Internet Control Message Protocol) packet received
3.	Interval between pings	Time interval in minutes between two Pings.	Minimum time interval is 5 minutes.
4.	Ping timeout (sec)	Time after which consider that Ping has failed.	Range(1-9999)
5.	Packet size	This box allows to modify sent packet size	Should be left default, unless necessary otherwise
6.	Retry count	Number of times to try sending Ping to server after time interval if echo receive was unsuccessful.	Minimum retry number is 1. Second retry will be done after defined time interval.
8.	Interface	Interface used for connection	
7.	Host to ping from SIM 1	IP address or domain name which will be used to send ping packets to. E.g. 127.0.0.1 (or www.host.com if DNS server is configured correctly)	Ping packets will be sending from SIM1.
8.	Host to ping from SIM 2	IP address or domain name which will be used to send ping packets to. E.g. 127.0.0.1 (or www.host.com if DNS server is configured correctly)	Ping packets will be sending from SIM2.

9.14.2 Periodic Reboot

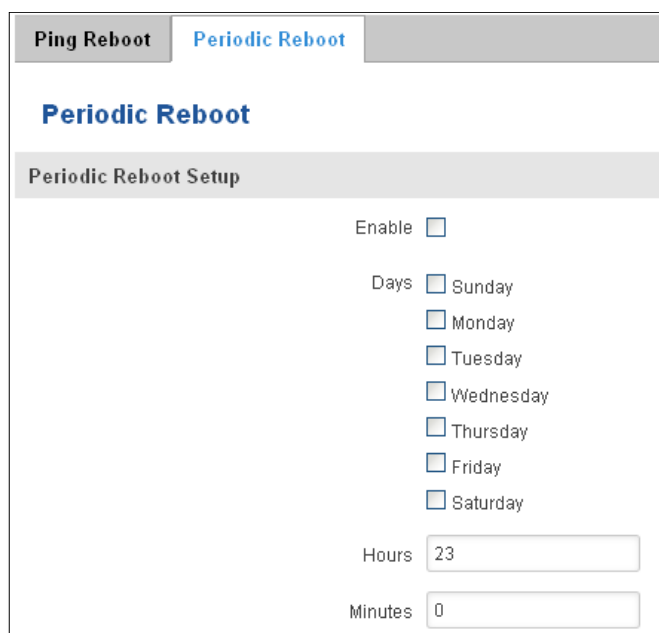

	Field name	Explanation
1.	Enable	This check box will enable or disable Periodic reboot feature.
2.	Days	This check box will enable router rebooting at the defined days.
3.	Hours, Minutes	Uploading will be done on that specific time of the day

9.15 UPnP

9.15.1 General Settings

UPnP allows clients in the local network to automatically configure the router.

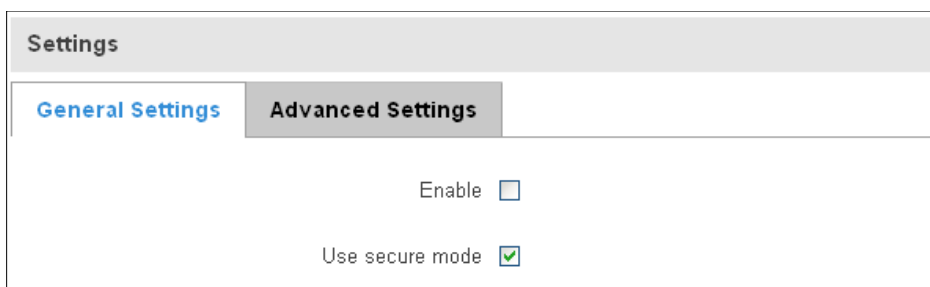

9.15.2 Advanced Settings

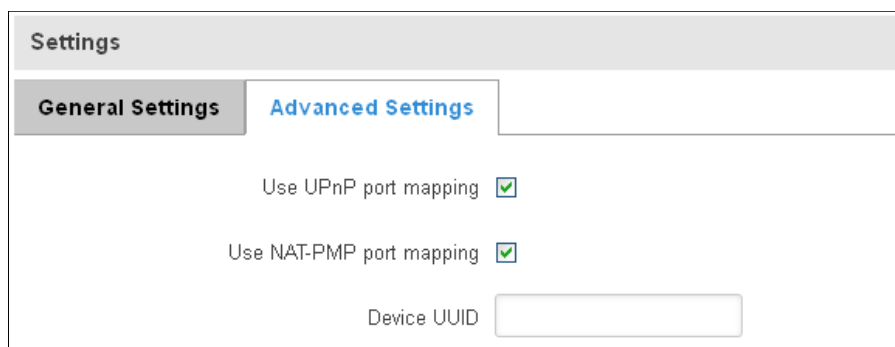

	Field name	Explanation
1.	Use UPnP port mapping	Enable UPnP port mapping functionality
2.	Use NAT-PMP port mapping	Enable NAT-PMP mapping functionality
3.	Device UUID	Specify Universal unique ID of the device

9.15.3 UPnP ACLs

ACLs specify which external ports may be redirected to which internal addresses and ports.

UPnP ACLs

ACLs specify which external ports may be redirected to which internal addresses and ports

Comment	External ports	Internal addresses	Internal ports	Action	Sort
<input type="text" value="Allow high ports"/>	<input type="text" value="1024-65535"/>	<input type="text" value="0.0.0.0/0"/>	<input type="text" value="1024-65535"/>	allow <input type="button" value="v"/>	<input type="button" value="up"/> <input type="button" value="down"/>

	Field name	Explanation
1.	Comment	Add comment to this rule
2.	External ports	External ports which may be redirected
3.	Internal addresses	Internal address to be redirect to
4.	Internal ports	Internal ports to be redirect to
5.	Action	Allow or forbid UPNP service to open the specified port

9.15.4 Active UPnP Redirects

Active UPnP Redirects

Protocol	External Port	Client Address	Client Port
<i>There are no active redirects.</i>			

9.16 QoS

QoS (Quality of Service) is the idea that transmission rates, error rates, and other characteristics can be measured, improved, and, to some extent, guaranteed in advance. QoS is of particular concern for the continuous transmission of high-bandwidth video and multimedia information.

QoS can be improved with traffic shaping techniques such as packet, network traffic, and port prioritization.

Interfaces

Interface	Enable	Calculate overhead	Half-duplex	Download speed (kbit/s)	Upload speed (kbit/s)
WAN	<input type="checkbox"/>	<input type="checkbox"/>	<input type="checkbox"/>	<input type="text" value="1024"/>	<input type="text" value="128"/>

Interface name:

	Field name	Value	Explanation
1.	Interface	WAN/LAN/PPP	
2.	Enable	Enable/Disable	Enable/disable settings
3.	Calculate overhead	Enable/Disable	Check to decrease upload and download ratio to prevent link saturation
4.	Half-duplex	Enable/Disable	Check to enable data transmission in both direction on a single carrier
5.	Download speed (kbit/s)	1024	Specify maximal download speed
6.	Upload speed (kbit/s)	128	Specify maximal upload speed

Classification Rules

Target	Source host	Destination host	Service	Protocol	Ports	Number of bytes	Sort
Priority <input type="button" value="v"/>	All <input type="button" value="v"/>	All <input type="button" value="v"/>	All <input type="button" value="v"/>	All <input type="button" value="v"/>	22,53 <input type="button" value="v"/>	<input type="text"/>	<input type="button" value="↑"/> <input type="button" value="↓"/> <input type="button" value="Delete"/>
Normal <input type="button" value="v"/>	All <input type="button" value="v"/>	All <input type="button" value="v"/>	All <input type="button" value="v"/>	TCP <input type="button" value="v"/>	20,21,25,80 <input type="button" value="v"/>	<input type="text"/>	<input type="button" value="↑"/> <input type="button" value="↓"/> <input type="button" value="Delete"/>
Express <input type="button" value="v"/>	All <input type="button" value="v"/>	All <input type="button" value="v"/>	All <input type="button" value="v"/>	All <input type="button" value="v"/>	5190 <input type="button" value="v"/>	<input type="text"/>	<input type="button" value="↑"/> <input type="button" value="↓"/> <input type="button" value="Delete"/>

	Field name	Explanation
1.	Target	Select target for which rule will be applied
2.	Source host	Select host from which data will be transmitted
3.	Destination host	Select host to which data will be transmitted
4.	Service	Select service for which rule will be applied
5.	Protocol	Select data transmission protocol
6.	Ports	Select which port will be used for transmission
7.	Number of bytes	Specify the maximal number of bytes for connection

9.17 Network Shares

9.17.1 Mounted File Systems

On this page you can review mounted file systems (for example USB flashdrive).

Mounted file systems Samba Samba user

Network Shares

Mounted file systems

Filesystem	Mount Point	Available	Used
/dev/sda1	/mnt/sda1	7.84 GB / 14.65 GB	47% (6.81 GB)

	Field name	Explanation
1.	File System	Filesystem on which additional file system is mounted
2.	Mount Point	Directory available for mounting additional file system
3.	Available	Total memory available in mounted system
4.	Used	Free memory in mounted system

9.17.2 Samba

Samba functionality allows network sharing for specified directories.

	Field name	Values	Notes
1.	Enable	Enable / Disable	Enables Samba service
2.	Hostname	Router_Share	Name of samba server
3.	Description	Teltonika_Router_Share	Short server description
4.	Workgroup	WORKGROUP	Name of the workgroup

In Shared Directories section you can add directories to be shared and configure some usage parameters:

	Field name	Values	Notes
1.	Name	My_dir	Name of the shared directory
2.	Path	/mnt/sda1	Path to directory to be shared
3.	Allow guests	Enable / Disable	Enable viewing the directory as a guest
4.	Allowed users	root	Specify users to be allowed to share this directory
5.	Read-only	Enable / Disable	Sets user's wrights in the specified directory to read-only

9.17.3 Samba User

In this page you can add new samba users.

Mounted file systems | Samba | **Samba user**

Samba users

Users

Username

This section contains no values yet

Add user:

Username **Password**

user pass1  Add

	Field name	Values	Notes
1.	Username	user	Name of new user
2.	Password	Pass1	New user's password

9.18 Input/Output

9.18.1 Status

In this page you can review the current state of all router's inputs and outputs.

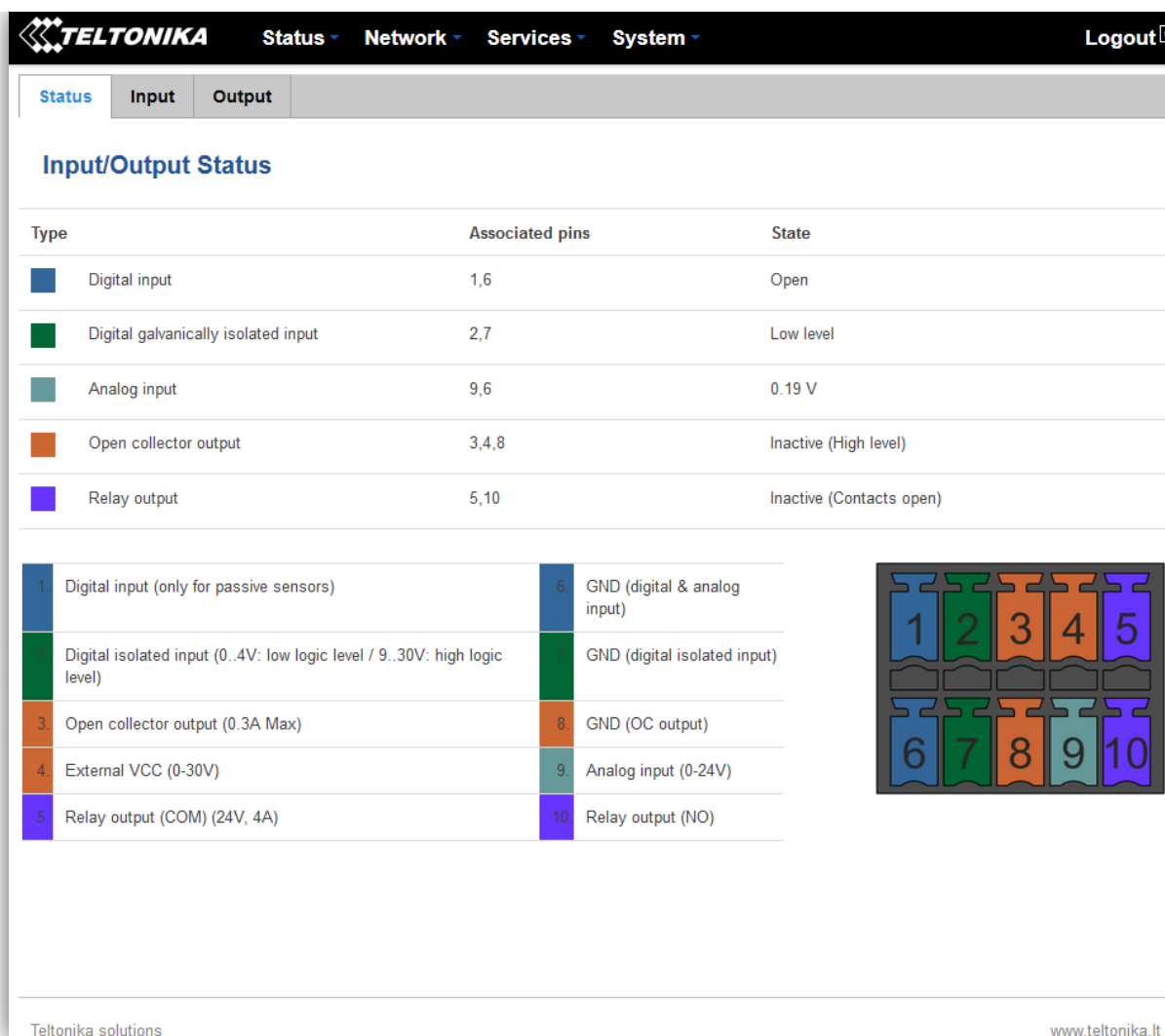

The screenshot shows the Teltonika web interface with the following elements:

- Navigation menu: Status, Network, Services, System, Logout
- Page title: Input/Output Status
- Table of I/O configurations:

Type	Associated pins	State
Digital input	1,6	Open
Digital galvanically isolated input	2,7	Low level
Analog input	9,6	0.19 V
Open collector output	3,4,8	Inactive (High level)
Relay output	5,10	Inactive (Contacts open)

1. Digital input (only for passive sensors)	6. GND (digital & analog input)
2. Digital isolated input (0..4V: low logic level / 9..30V: high logic level)	7. GND (digital isolated input)
3. Open collector output (0.3A Max)	8. GND (OC output)
4. External VCC (0-30V)	9. Analog input (0-24V)
5. Relay output (COM) (24V, 4A)	10. Relay output (NO)

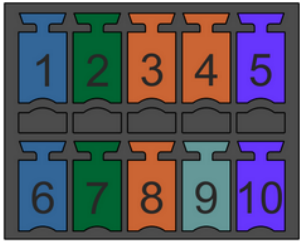

Pinout diagram showing 10 pins with color-coded labels: 1 (blue), 2 (green), 3 (orange), 4 (orange), 5 (purple), 6 (blue), 7 (green), 8 (orange), 9 (teal), 10 (purple).

Teltonika solutions www.teltonika.it

9.18.2 Input

Allows you to set up input parameters and specify what actions should be taken after triggering event of any input. In check analog section you can change the analog input checking interval.

Status **Input** Output

Input/Output

Create rules for Input/Output configuration.

Check Analog

Interval [sec]

Input Rules

Type	Trigger	Action	Enable	Sort
------	---------	--------	--------	------

There are no input rules created yet

Input Configuration

Input type	Analog type	Trigger	Action	
Analog ▾	Analog Voltage ▾	Inside range ▾	Send SMS ▾	<input type="button" value="Add"/>

- Analog Voltage
- Analog Current

In the input rules section you can create and modify the rules for action after specific input triggering.

Input Rules

Type	Trigger	Action	Enable	Sort	
Digital	Input open	Send SMS	<input checked="" type="checkbox"/>	<input type="button" value="↑"/> <input type="button" value="↓"/>	<input type="button" value="Edit"/> <input type="button" value="Delete"/>

	Field name	Sample	Explanation
1.	Type	Digital/Digital isolated/Analog	Specifies input type
2.	Triger	Input open	Specifies for which trigger rule is applied
3.	Action	Send SMS	Specifies what action is done
4.	Enable	Enable/Disable	Enable input configuration

Input Configuration

Input type	Analog type	Trigger	Action	
Analog ▾	Analog Voltage ▾	Inside range ▾	Send SMS ▾	<input type="button" value="Add"/>

- Analog Voltage
- Analog Current

Field name	Values	Explanation
------------	--------	-------------

1.	Input type	Digital/Digital isolated/Analog	Specify input type
1.a	Analog type	Analog Voltage/Analog Current	Specify voltage or current measurement
2.	Triger	Input open / Input shorted/ both	Specify for which trigger rule will be applied
3.	Action	Send SMS/ Change SIM card/ Send email/ Change profile/ Turn WiFi ON or OFF/Reboot/ Output	Choose what action will be done after input triggering

After clicking on ADD button (Or Edit, if the rule is already created) you get the second input configuration page with extra parameters to set.

	Field name	Sample	Explanation
1.	Enable	Enable/Disable	Enable this input rule
2.	Input type	Digital/Digital isolated/Analog	Specify the input type
3.	Min V/mA	10	Specify minimum voltage/current. Only shown when Input type is Analog
4.	Max V/mA	20	Specify maximum voltage/current. Only shown when Input type is Analog
5.	Triger	Input open	Specify for which trigger rule will be applied
6.	Action	Send SMS	Specify what action to do
7.	SMS text	Input	Specify message to send in SMS
8.	Recipients phone number	+37012345678	Phone number where you will get SMS. Only shown when Action is Send SMS
9.	Subject	Input	Specify subject of email. Only shown when Action is Send email
10.	Message	Input	Specify message to send in email. Only shown when Action is Send email
11.	SMTP server	mail.example.com	Specify SMTP (Simple Mail Transfer Protocol) server. Only shown when Action is Send email
12.	SMTP server port	123	Specify SNMP server port. Only shown when Action is Send email
13.	Secure connection	Enable/Disable	Specify if server support SSL or TLS. Only shown when Action is Send email
14.	User name	username	Specify user name to connect SNMP server. Only shown when Action is Send email
15.	Password	password	Specify the password of the user. Only shown when Action is Send email
16.	Sender's email	sender@example.com	Specify your email address. Only shown when Action is Send email

	address		
17.	Recipient's email address	recipient@example.com	Specify for whom you want to send email. Only shown when Action is Send email
18.	Sim	Primary/ Secondary	Specify which one SIM card will be changed. Only shown when Action is Change SIM Card
19.	Profile	Admin	Specify which profile will be set and used. Only shown when Action is Change Profile
20.	Reboot after (s)	4	Device will reload after a specified time (in seconds). Only shown when Action is Reboot
21.	Output activated	10	Output will be activated for specified time (in seconds) , or while exists.
22.	Output type	Digital OC output/ Relay output	Specify output type, which will be activated, depending on output time. Only shown when Action is Activate output

9.18.3 Output

9.18.3.1 Output Configuration

	Field name	Sample	Explanation
1.	Open collector output	Low level / High level	Choose what open collector output will be in active state
2.	Relay output	Contacts closed / Contacts open	Choose what relay output will be in active state

9.18.3.2 ON/OFF

	Field name	Sample	Explanation
1.	Digital OC output	Turn on / Turn Off	Manually toggle Digital OC output
2.	Digital relay output	Turn on / Turn Off	Manually toggle Digital relay output

9.18.3.3 Post/Get Configuration

Output Configuration	ON/OFF	Post/Get Configuration	Periodic Control	Scheduler
Post/Get Configuration				
Output Post/Get Settings				
Enable <input type="checkbox"/>				
Username <input type="text" value="user1"/>				
Password <input type="text" value="pass1"/> 				

	Field name	Example	Explanation
1.	Enable	Enable /Disable	Enable POST/GET output functionality
2.	Username	User1	Service user name
3.	Password	Pass1	User password for authentication

9.18.3.4 Syntax of Output HTTP POST/GET string

With Output post/get you can manage only Outputs (Open collector output and Digital relay output).

	Field name	Example	Explanation
1.	IP_ADDRESS	192.168.1.1	IP address of your router
2.	action	on and off	Specify the action to be taken
3.	pin	oc and relay	Specify the output
4.	delay (sec)	15	Delay in seconds after which action will be started
5.	time (sec)	10	Time in seconds after which the action will be stopped. (if action is on, then it will go back to off after *time*)

Please note:

Delay and time parameters can be used together. Example: delay is 10, time is 5, action is „on“. 10 seconds after command execution output will switch to „on“ (or stay in „on“ state if it’s already on), then after 5 more seconds it will switch to off state. Overall command execution time is 15 seconds.

Actions „on“ and „off“ depend on setting „Output configuration in active state“ (on is active state), which can be set via Services > Input/Output > Output

9.18.3.5 Output HTTP POST/GET string examples

```

http://192.168.1.1/cgi-bin/output?username=User1&password=Pass1&action=on&pin=relay
http://192.168.1.1/cgi-bin/output?username=User1&password=Pass1&action=on&pin=relay&delay=10
http://192.168.1.1/cgi-bin/output?username=User1&password=Pass1&action=on&pin=relay&time=5
http://192.168.1.1/cgi-bin/output?username=User1&password=Pass1&action=on&pin=relay&delay=15&time=5
http://192.168.1.1/cgi-bin/output?username=User1&password=Pass1&action=off&pin=relay&delay=15&time=5
http://192.168.1.1/cgi-bin/output?username=User1&password=Pass1&action=on&pin=oc
http://192.168.1.1/cgi-bin/output?username=User1&password=Pass1&action=off&pin=oc

```

9.18.3.6 Periodic Control

Periodic control function allows user to set up schedule by which the outputs are either turned ON or OFF at specific time.

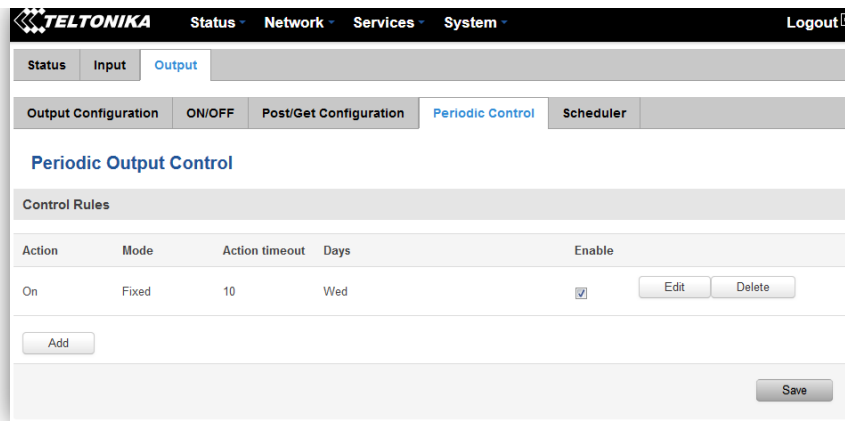

After clicking on ADD button (Or Edit, if the rule is already created) you get the second periodic output configuration page with extra parameters to set.

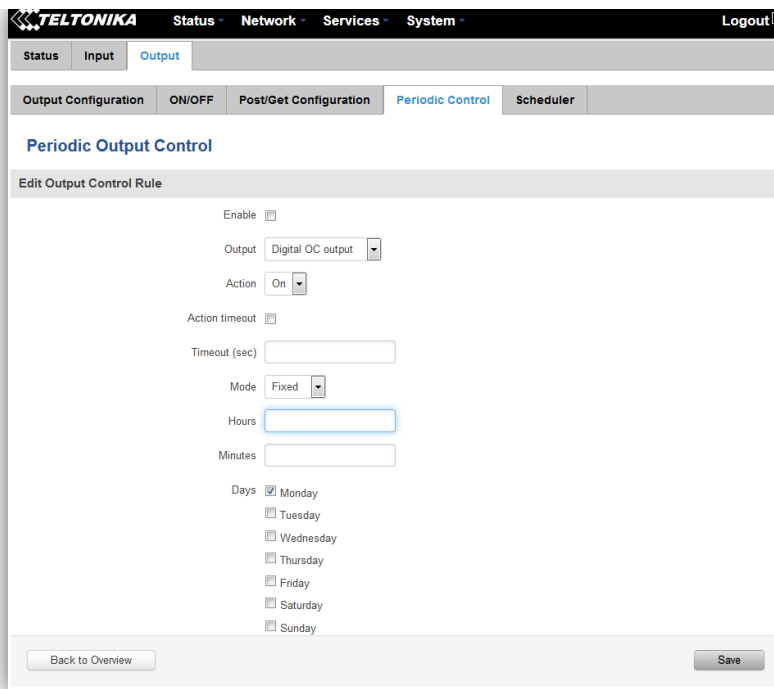

	Field name	Sample	Explanation
1.	Enable	Enable/Disable	Enable this output rule
2.	Output	Digital/Digital isolated/Analog	Specify the output type
3.	Action	On / Off	Specify the action to be taken
4.	Action timeout	Enabled / Disabled	Enable timeout for this rule
5.	Timeout (sec)	10	Specifies after how much time this action should end.
6.	Mode	Fixed / Interval	Specify the mode of output activation
7.	Hours	15	Specify the hour for rule activation
8.	Minutes	25	Specify the minute for rule activation
9.	Days	Monday	Select the week days for rule activation

9.18.3.7 Scheduler

This function allows you to set up the periodical, hourly schedule for the outputs. You can select on which week days the outputs are going to be on or off.

Output Configuration ON/OFF Post/Get Configuration Periodic Control **Scheduler**

Output Scheduler

Configure Scheduled Outputs

Output:

Days/Hours	0-1h	1-2h	2-3h	3-4h	4-5h	5-6h	6-7h	7-8h	8-9h	9-10h	10-11h	11-12h	12-13h	13-14h	14-15h	15-16h	16-17h	17-18h	18-19h	19-20h	20-21h	21-22h	22-23h	23-24h
Monday								Both active	Both active	Both active	Both active													
Tuesday																								
Wednesday				Digital OC output active	Digital OC output active	Digital OC output active																		
Thursday																			Digital relay output active (relay contacts closed)	Digital relay output active (relay contacts closed)				
Friday						Digital relay output active (relay contacts closed)	Digital relay output active (relay contacts closed)	Digital relay output active (relay contacts closed)																
Saturday													Both active	Both active										
Sunday																								

■ Digital OC output active
■ Digital relay output active (relay contacts closed)
■ Both active

9.18.4 Input/Output hardware information

The Input/output (I/O) connector is located in the front panel next to LEDs. Pin-out of the I/O connector:

1. Digital input (only for passive sensors)	6. GND (digital & analog input)
2. Digital isolated input (0..4V: low logic level / 9..30V: high logic level)	7. GND (digital isolated input)
3. Open collector output (0.3A Max)	8. GND (OC output)
4. External VCC (0-30V)	9. Analog input (0-24V)
5. Relay output (COM) (24V, 4A)	10. Relay output (NO)

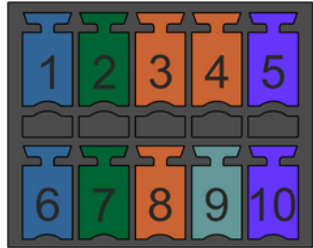

Type	Description	Ratings	QTY
Input (digital)	Digital non-isolated input for passive sensors	3V Max	1
Input(digital)	Digital input with galvanic isolation	0..4V – low level 9..30V – high level	1
Input (analog voltage/current)	Analog input (0-24V/0-20mA)	24V/20mA Max (with 1.2kΩ shunt)	1
Output (Open collector)	Open collector (OC) output	30V, 0.3A	1
Output (relay)	SPST relay output	24V, 4A	1

9.18.4.1 Digital input for passive sensors



Absolute maximum ratings:

Maximum voltage on input pin1 with respect to pin6: **3V**

Minimum voltage on input pin1 with respect to pin6: **0V**

The input is protected from short positive or negative ESD transients

This input is designed for connecting sensors with passive output (not outputting voltage) such as:

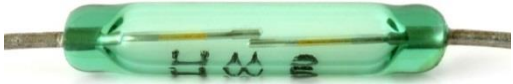
Passive infrared (PIR) sensors for motion detection (sensors with open collector or relay output are suitable type to use)	
Mechanical Switches, pushbuttons	 SPST
Reed switches, which opens or closes its contacts when magnetic field is near	
Any sensor with open collector or open drain output (use without pull-up resistor)	

Example schematic of using PIR sensors, mechanical switches, reed switches:

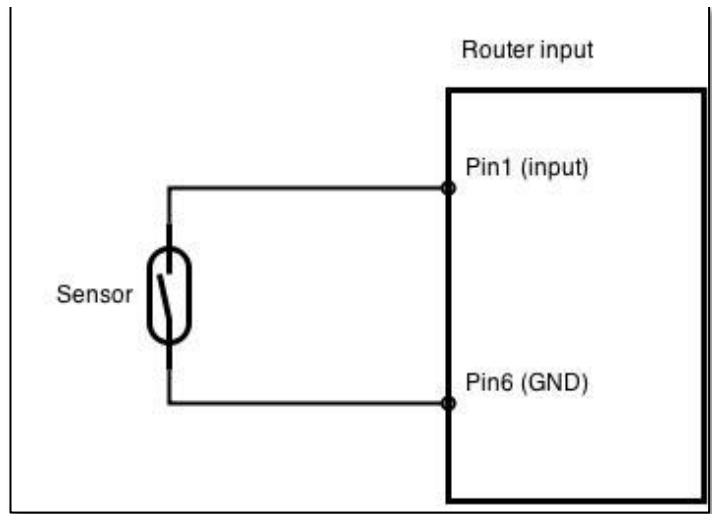

Example schematic of connecting multiple sensors with open collector outputs:

Multiple sensors can be connected in parallel like in the schematic below. In this configuration any sensor will activated the input. The example could be multiple motion sensors located in multiple places. If either of them will sense motion, the configured event (for e.g. alarm) will be activated. This is suitable when you just need to know that alarm is triggered but it is not necessary to know which sensor activated an alarm.

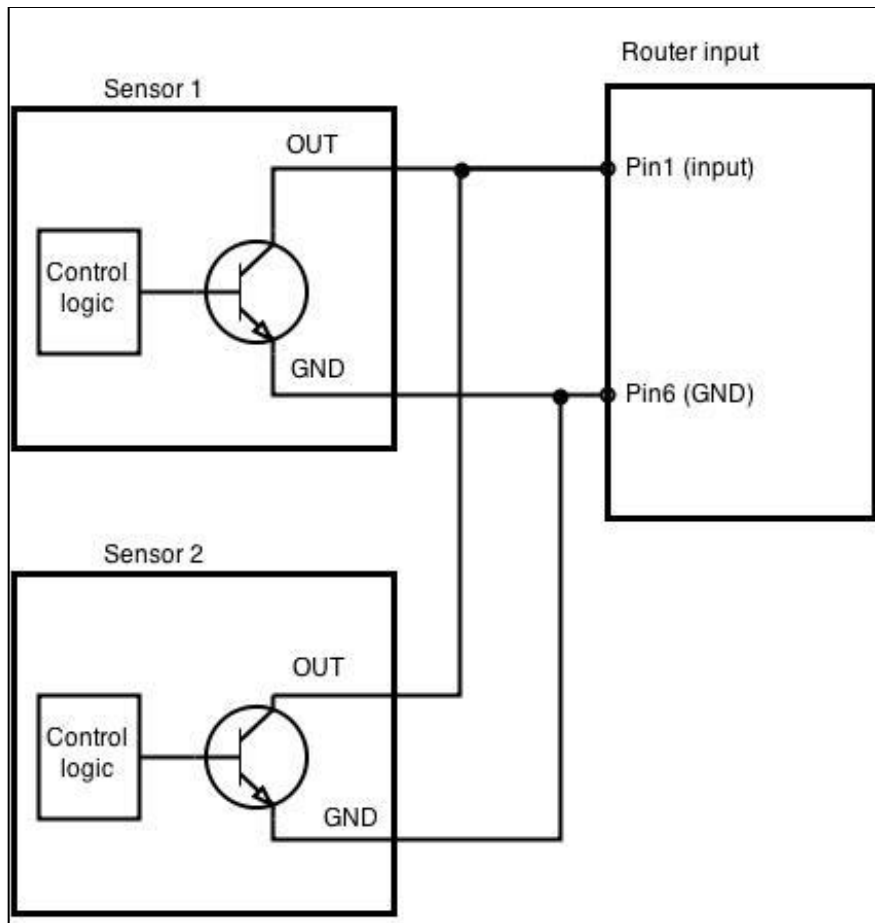

9.18.4.2 Digital galvanically isolated input

Sensors with push-pull output stage can be connected to this input. Example of such circuit is shown in the picture below. The circuit uses optocoupler to isolate the input. In case of the failure at the input, the rest of the circuit remains safe.

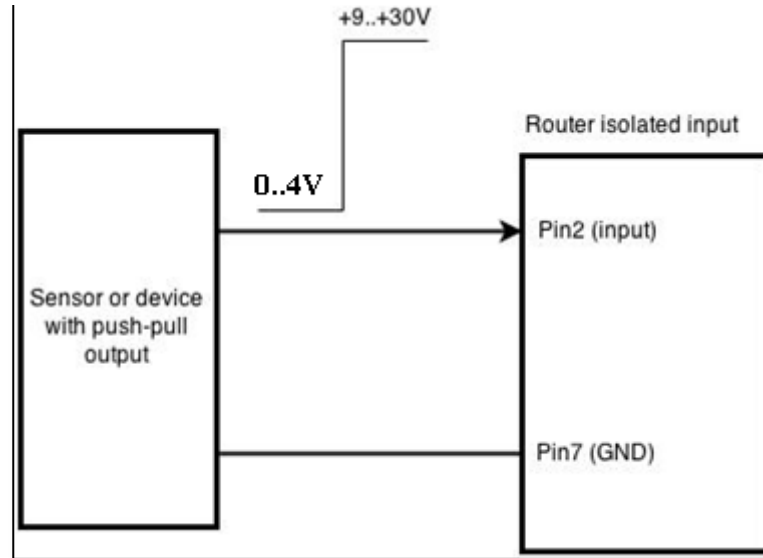

The signal source resistance should be less than 100Ω.

Input voltage levels:

- Low level voltage: **0..+4V**
- High level voltage: **+9..30V**

Maximum ratings:

- Maximum voltage that can be connected to pin2 with respect to pin7 is **30V**. Do not exceed this voltage!
- The input is protected from reverse voltage down to -200V.

9.18.4.3 Analog input

Analog input is designed to measure analog voltages in the range of 0-24V and convert it to digital domain. This input can also be used to measure current up to 20mA.

Example of monitoring 12V battery voltage:

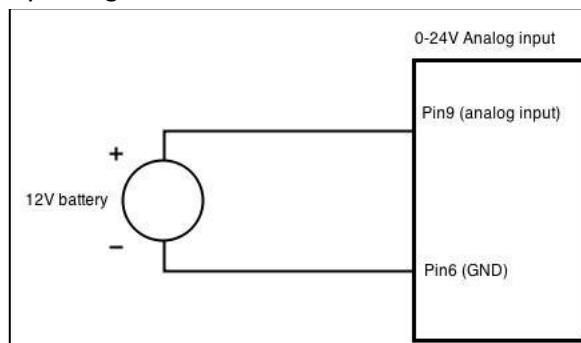

When Analog input type is „Analog Current“ a 1.2kΩ resistor shunt must be connected as shown below:

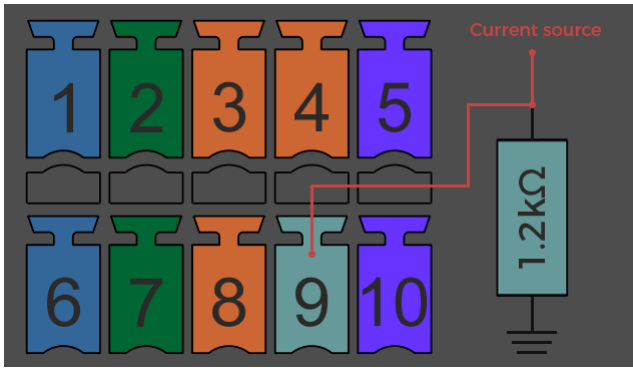

Input electrical characteristics:

Parameter	Value
Maximum voltage	24V
Minimum voltage	0V
Resolution	5.859mV
Input low-pass filter cut-off frequency (-3dB)	10Hz
Input resistance (seen between I/O header pins 9 and 6)	131kΩ

Input accuracy:

Input voltage range, V	Measurement error, %
0 <Vin ≤ 1	<20
1 <Vin ≤ 2	<10
2 <Vin ≤ 5	<5
5 <Vin ≤ 24	<3

9.18.4.4 Open collector output

This output can be used to drive external relay. In order for the output to work correctly, external voltage that is connected to a relay also needs to be connected to I/O header pin 4. There is flyback diode located inside the device to protect it from spikes occurring when inductive load (relay coil) is suddenly switched off, so connection of the external diode is not necessary. The output is isolated from the rest of the circuitry using optocoupler. In case of the output failure, the rest of the circuit will remain protected.

Maximum external DC voltage	30V
Maximum output sink current	0.3A

Example of driving a relay:

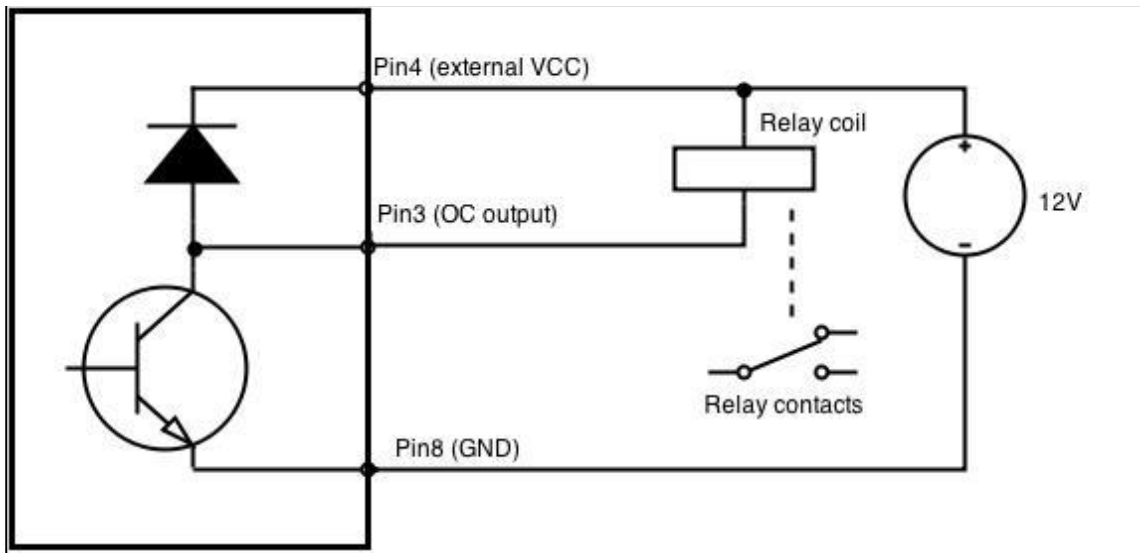

Output can be also used to generate signals with desired amplitude. Resistor could be for example 4.7k Ω .

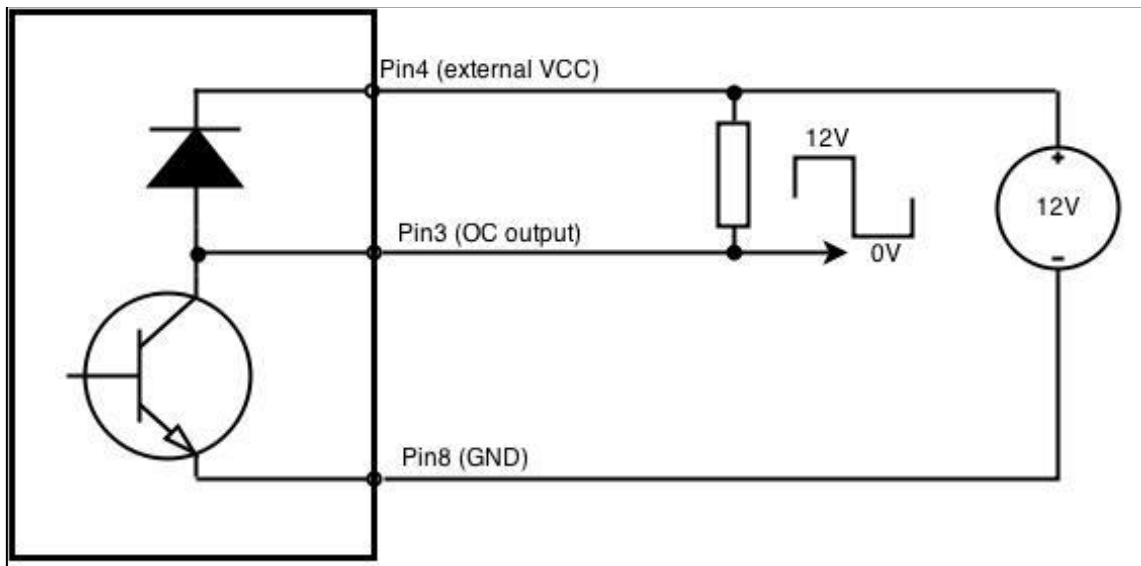

9.18.4.5 Relay output

Relay output has two pins: COM and NO. When the relay is not energized (output not active), these pins are disconnected. One the relay is energized (output active) these pins are become connected together. Relay output is not intended to drive AC voltages.

Maximum DC voltage across relay contacts	24V
Maximum relay DC current	4A

Example of connecting alarm siren to the relay output:

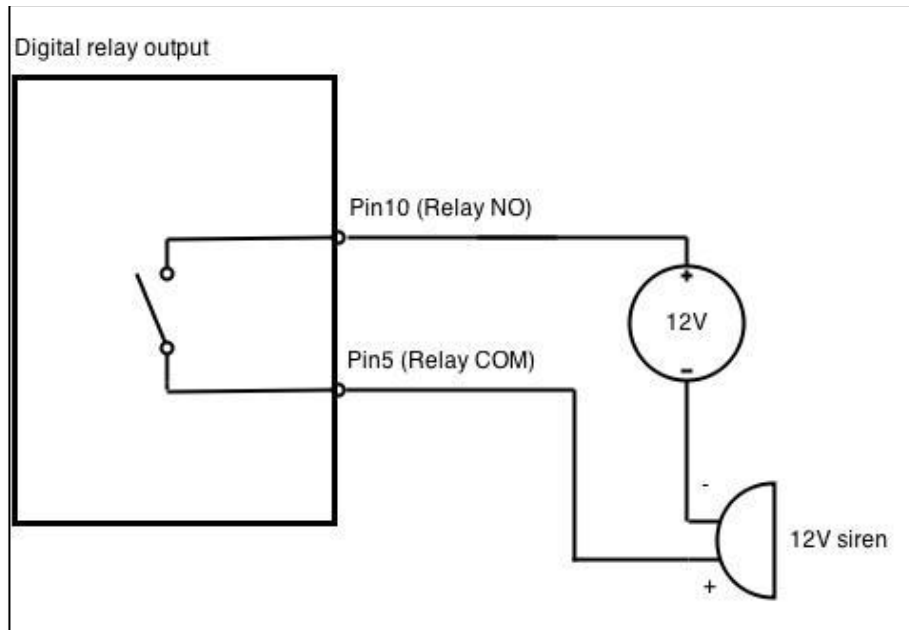

9.19 MQTT

MQTT also known as MQ Telemetry Transport is an publish-subscribe based messaging protocol for use on top of the TCP/IP protocol. It is designed to send short messages from one client (publisher) to another (subscriber) through the brokers, which are responsible for message delivery to the end point. RUT 9XX routers do support this functionality via open source Mosquitto broker. The messages are sent in this way: some client (subscriber) subscribes to specific topic or many of them, and then publisher posts some message to specific topic. The broker then checks who is subscribed to particular topic and transmits data from publisher to subscriber.

RUT9XX supports some functionality of the MQTT broker and MQTT publisher. The main window of parameters is presented below. The broker can be enabled by checking *Enable* and entering the port number on which MQTT broker should run to. In order to accept connections from WAN interface, *Enable Remote Access* should be checked also.

MQTT Broker

Enable

Local Port

Enable Remote Access

Broker settings

Security

Bridge

Miscellaneous

Use TLS/SSL

Save

In order to use TLS/SSL for connecting clients (subscribers and publishers) to the broker, the one should check *Use TLS/SSL*. After that, additional settings will be displayed to the user as shown below. Here the user can upload certificates, key files and choose TLS version, which will be used for data encryption between broker and clients (subscribers and publishers)

Security

Bridge

Miscellaneous

Use TLS/SSL

CA File No file selected.

CERT File No file selected.

Key File No file selected.

TLS version

The MQTT broker also supports option called *Bridge*. It means, that two brokers can be connected to each other and share messages. The window of bridge parameters are presented below. There are some mandatory parameters, like *Connection Name*, *Remote Address* and *Remote Port*. Although connection name is mandatory, it should be set to value what you like and according to mosquitto's user manual this option denotes the client ID which will be used when connecting to remote broker. There are some other parameters. If you would like to know that they mean and how to use them you should check for mosquitto.conf manual page.

Security

Bridge

Miscellaneous

Enable

Connection Name

Remote Address

Remote Port

1883

Use Remote TLS/SSL

Use Remote Bridge Login

Topic



Try Private

Clean Session

The last section of parameters is called *Miscellaneous*. It contains parameters, which does not depend on neither *Security*, nor *Bridge* categories. *ACL File* denotes access control list file name. The contents of this file are used to control client access to topics of the broker. The *Password File* denotes the file, there users and corresponding passwords are stored. This file is used for user authentication. This option is related to another option called *Allow Anonymous*. If *Allow Anonymous* is unchecked, only users, which exist in password file will be able to connect to the broker. More about password file can be read on mosquitto configuration manual. The last option is called *Persistence*, it allows to save connection, subscription and message data to the disk, otherwise, the data is stored in memory only.

Security
Bridge
Miscellaneous

ACL File No file selected.

Password File No file selected.

Persistence

Allow Anonymous

It is possible to configure some sort of MQTT publisher. It is not simple publisher, but publisher, which publishes some system parameters to the broker. The publisher configuration window has few fields, like hostname and port of the broker to connect. Username and password fields are used for authentication. If these fields are left empty, no authentication is performed.

Broker
Publisher

MQTT Publisher

Enable

Hostname

Port

Username

Password

The full list of system parameters, which can be published, are described below.

Parameter name	Parameter description
temperature	Get temperature of the module in 0.1 degrees Celcium
operator	Get current operator's name
signal	Get signal strength in dBm
network	Get current network type (2G, 3G, 4G, etc')

connection	Check if data connection is available
wan	Get WAN's IP address
uptime	Get system uptime in seconds
name	Get router's name
digital1	Get value of digital input no. 1
digital2	Get value of digital input no. 2
analog	Get value of analog input

In order system to work, MQTT broker should be configured in advance. You can use the broker, which is installed inside the router, or the broker in the other location. The publisher operates according to the scheme presented below. In the scheme the client tries to subscribe information about router's uptime. To achieve this multiple commands between client and publisher are being sent.

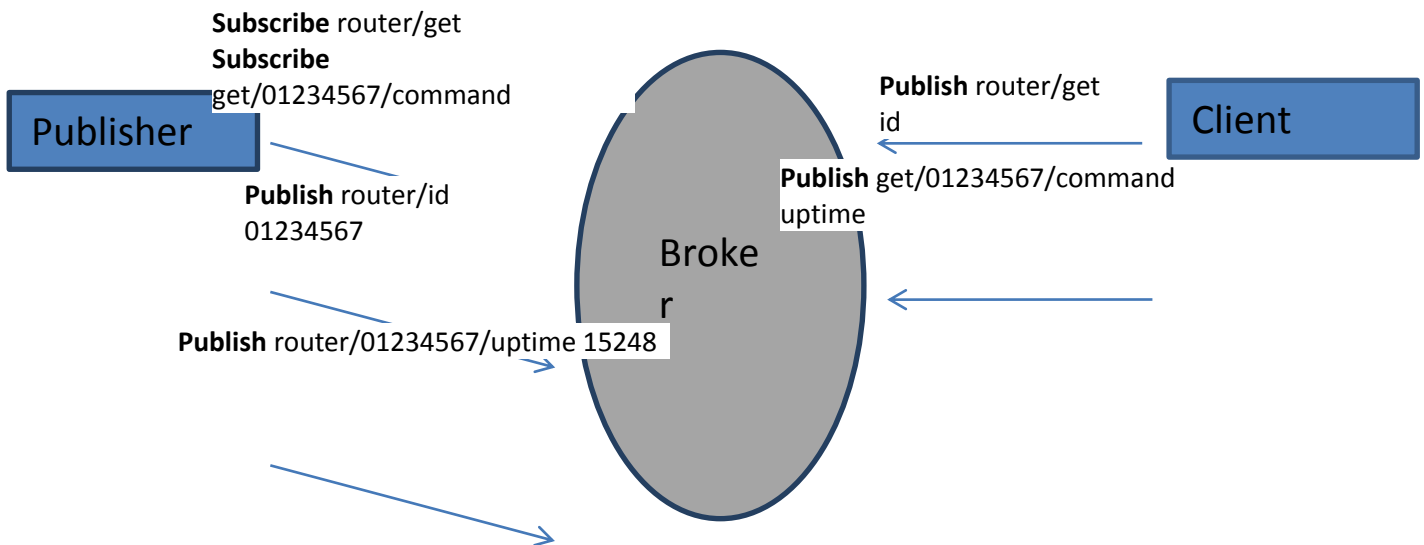

In general publisher works in such a way: connects to the broker and subscribes to the topics *router/get* and *get/<SERIAL>/command*, there *<SERIAL>* denotes serial number of the router which is currently run publisher. The client then sends message *id* to the topic *router/get*. The following message is received by the publisher, since it is subscribed to that topic. Then the publisher sends response with its serial number to the topic *router/id*. Now the client knows that publisher with some serial number exist. It means, that client can send message with parameter name from the list as a message to the topic *get/<SERIAL>/command* to the broker. The message will be received only by the subscriber, which has the same SERIAL number mentioned in the topic. Now the publisher can send back a response with *router/<SERIAL>/parameter_name* topic and message with a value of requested parameter. It should be noted, that according to MQTT protocol, the topic names are case-sensitive, for example topic *router* is not the same as topic *RoUtEr*.

9.20 Modbus TCP interface

Modbus TCP

Enable

Port

Allow Remote Access

Save

Modbus TCP interface allows the user to set or get some parameters like module temperature, signal strength, etc. from the router. In other words, Modbus TCP allows to control routers behavior and get its status information. To use Modbus TCP capabilities this feature must be enabled by navigating to Services-Modbus. After “Save” button is pressed, the Modbus daemon will be launched on selected port of the system. Modbus daemon acts as slave device that means, it accepts connection from the master (client) and sends out a response or sets some system related parameter. By the default Modbus will only accept connections through LAN interface. In order to accept connections through WAN interface also, Allow Remote Access must be checked.

To obtain some parameter from the system, the read holding registers command is used. The register number and corresponding system values are described below. Each register contains 2 bytes. For simplification the number of registers for storing numbers is 2, while for storing text information the number of registers is 16.

Required value	Representation	Register number	Number of registers
System uptime	32 bit unsigned integer	1	2
GSM signal strength (dBm)	32 bit integer	3	2
System temperature in 0.1 degrees Celcium	32 bit integer	5	2
System hostname	Text	7	16
GSM operator name	Text	23	16
Router serial number	Text	39	16
Router MAC address	Text	55	16
Router name	Text	71	16
Current SIM card	Text	87	16
Network registration	Text	103	16
Network type	Text	119	16
Digital input 1	32 bit integer	135	2
Digital input 2	32 bit integer	137	2
Current WAN IP address	32 bit unsigned integer	139	2
Analog input	32 bit integer	141	2

The Modbus daemon also supports setting of some system parameters. For this task write holding register command is used. System related parameters and how to use them are described below. The register number refers to the register number where to start write required values. All commands, except “Change APN” accepts only one input parameter. For the APN the number of input registers may vary. The very first byte of APN command denotes a number

of SIM card for which set the APN. This byte should be set to 1 (in order to change APN for SIM card number 1) or to 2 (in order to change APN for SIM card number 2).

Value to set	Description	Register number	Register value
Digital output 1 (on/off)	Change the state of the digital output number 1	201	1/0
Digital output 2 (on/off)	Change the state of the digital output number 2	202	1/0
Switch WiFi (on/off)	Allows to switch WiFi on or off	210	1/0
Switch mobile data connection (on/off)	Turns on or off mobile data connection	211	1/0
Switch SIM card (SIM1, SIM2, SIM1->SIM2 and SIM2->SIM1)	Allows to change SIM card in use, 3 possible options are supported	212	0/1/2
Change APN	Allows to change APN	213	APN code
Reboot	Reboots a router	220	1

10 System

10.1 Configuration Wizard

The configuration wizard provides a simple way of quickly configuring the device in order to bring it up to basic functionality. The wizard is comprised out of 4 steps and they are as follows:

Step 1 (General change)

First, the wizard prompts you to change the default password. Simply enter the same password into both Password and Confirmation fields and press **Next**.

Step 1 - General Step 2 - Mobile Step 3 - LAN Step 4 - WiFi

Step - General

First, let's change your router password from the default one.

Password Settings

New password

Confirm new password

Time Zone Settings

Current system time 2016-03-16 09:27:33 Sync with browser

Time zone

Step 2 (Mobile Configuration)

Next we have to enter your mobile configuration. On a detailed instruction on how this should be done see the Mobile section under Network

Step 1 - General Step 2 - Mobile Step 3 - LAN Step 4 - WiFi

Mobile Configuration

Next, let's configure your mobile settings so you can start using internet right away.

Mobile Configuration (SIM1)

Operator profile

APN

PIN number

Dialing number

Authentication method

Service mode

Show mobile info at login page

Step 3 (LAN)

Next, you are given the chance to configure your LAN and DHCP server options. For a detailed explanation see LAN under Network.

Step 1 - General Step 2 - Mobile **Step 3 - LAN** Step 4 - WiFi

Step - LAN

Here we will setup the basic settings of a typical LAN configuration. The wizard will cover 2 basic configurations: static IP address LAN and DHCP client.

General Configuration

IP address

Netmask

Enable DHCP

Start

Limit

Lease time

Step 4 (Wi-Fi)

The final step allows you to configure your wireless settings in order to set up a rudimentary Access Point.

Step 1 - General Step 2 - Mobile Step 3 - LAN **Step 4 - WiFi**

Step - Wireless

Now let's configure your wireless radio. (Note: if you are currently connecting via wireless and you change parameters, like SSID, encryption, etc. your connection will be dropped and you will have to reconnect with a new set of parameters.)

WiFi Configuration

Enable wireless

SSID

Mode

Channel

Encryption

Country Code

When you're done with the configuration wizard, press **Save**.

10.2 Profiles

Router can have 5 configuration profiles, which you can later apply either via WebUI or via SMS. When you add New Profile, you save **current** full configuration of the router. Note: profile names **cannot** exceed 10 symbols.

Configuration Profiles

Manage Profiles

Profile name

Profile name	Created	Action
Profile	2016-03-15	<input type="button" value="Apply"/> <input type="button" value="Delete"/>

10.3 Administration

10.3.1 General

[General](#)
[Troubleshoot](#)
[Backup](#)
[Access Control](#)
[Diagnostics](#)
[MAC Clone](#)
[Overview](#)
[Monitoring](#)

Administration Settings

Router Name And Host Name

Router name

Host name

Administrator Password

New password 

Confirm new password 

Language Settings

Language

IPv6 Support

Enable

Login Page

Show mobile info at login page

Show WAN IP at login page

Leds indication

Enable

Restore Default Settings

Restore to default

	Field name	Explanation
1.	Router name	Enter your new router name.
2.	Host name	Enter your new host name
3.	New Password	Enter your new administration password. Changing this password will change SSH password as well.
4.	Confirm new password	Re-enter your new administration password.

5.	Language	Website will be translated into selected language.
6.	IPv6 support	Enable IPv6 support on router
7.	Show mobile info at login page	Show operator and signal strength at login page.
8.	Show WAN IP at login page	Show WAN IP at login page.
9.	On/Off LEDs	If uncheck, all routers LEDs are off.
10.	Restore to default	Router will be set to factory default settings

Important notes:

The only way to gain access to the web management if you forget the administrator password is to reset the device factory default settings. Default administrator login settings are:

User Name: **admin**

Password: **admin01**

10.3.2 Troubleshoot

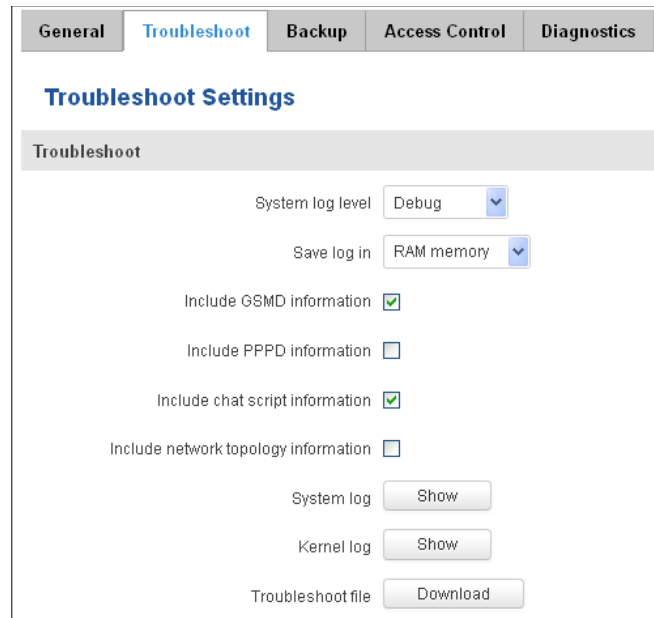

	Field name	Explanation
1.	System log level	Debug level should always be used, unless instructed otherwise.
2.	Save log in	Default RAM memory should always be used unless instructed otherwise.
3.	Include GSMD information	Default setting – enabled should be used, unless instructed otherwise.
4.	Include PPPD information	Default setting – disabled should be used, unless instructed otherwise.
5.	Include Chat script information	Default setting – enabled should be used, unless instructed otherwise.
6.	Include network topology information	Default setting – disabled should be used, unless instructed otherwise.
7.	System Log	Provides on-screen System logging information. It does not, however, substitute troubleshooting file that can be downloaded from System -> Backup and Firmware menu.
8.	Kernel Log	Provides on-screen Kernel logging information. It does not, however, substitute troubleshooting file that can be downloaded from System -> Backup and Firmware menu.

9.	Troubleshoot file	Downloadable archive, that contains full router configuration and all System log files.
----	-------------------	---

10.3.3 Backup

The screenshot shows a web interface with a navigation bar containing tabs: General, Troubleshoot, Backup (selected), Access Control, Diagnostics, and MAC Clone. Below the navigation bar, the page title is "Backup".

The "Backup Configuration" section contains a label "Backup archive:" followed by a "Download" button.

The "Restore Configuration" section contains a dropdown menu labeled "Upgrade from file" with a downward arrow. Below this, there is a label "Restore from backup:" followed by a "Browse..." button and the text "No file selected.". At the bottom of this section is an "Upload archive" button.

	Field name	Explanation
1.	Backup archive	Download current router settings file to personal computer. This file can be loaded to other RUT955 with same Firmware version in order to quickly configure it.
2.	Restore from backup	Select, upload and restore router settings file from personal computer.

10.3.3.1 Access control

10.3.3.1.1 General

The screenshot shows the 'Access Control' configuration page. It features a navigation bar with tabs: General, Troubleshoot, Backup, Access Control (selected), Diagnostics, and MAC Clone. Below this, there are sub-tabs: General and Safety. The main content area is titled 'Access Control' and is divided into three sections:

- SSH Access Control:**
 - Enable SSH access:
 - Remote SSH access:
 - Port:
- Web Access Control:**
 - Enable HTTP access:
 - Enable remote HTTP access:
 - Port:
 - Enable remote HTTPS access:
 - Port:
- CLI Configuration:**
 - Enable CLI:
 - Enable remote CLI:
 - Port:

	Field name	Explanation
1.	Enable SSH access	Check box to enable SSH access.
2.	Remote SSH access	Check box to enable remote SSH access.
3.	Port	Port to be used for SSH connection
4.	Enable HTTP access	Enables HTTP access to router
5.	Enable remote HTTP access	Enables remote HTTP access to router
6.	Port	Port to be used for HTTP communication
7.	Enable remote HTTPS access	Enables remote HTTPS access to router
8.	Port	Port to be used for HTTPS communication
9.	Enable CLI	Enables Command Line Interface
10.	Enable remote CLI	Enables remote Command Line Interface
11.	Port	Port to be used for CLI communication

Note: The router has 2 users: “**admin**” for WebUI and “**root**” for SSH. When logging in via SSH use “**root**”.

10.3.3.1.2 Safety

The screenshot shows the 'Access Control' configuration page. The 'Safety' sub-tab is active. Under 'Block Unwanted Access', there are two sections: 'SSH Access Secure' and 'WebUI Access Secure'. Each section has an 'Enable' checkbox (unchecked), a 'Clean after reboot' checkbox (unchecked), and a 'Fail count' input field set to '5'. Below these is a 'List Of Blocked Addresses' section with a search bar and a table that currently shows 'There are no addresses blocked'.

	Field name	Explanation
1.	SSH access secure enable	Check box to enable SSH access secure functionality.
2.	Clean after reboot	If check box is selected – blocked addresses are removed after every reboot.
3.	Fail count	Specifies maximum connection attempts count before access blocking.
4.	WebUI access secure enable	Check box to enable secure WebUI access.

10.3.4 Diagnostics

The screenshot shows the 'Diagnostics' configuration page. The 'Diagnostics' sub-tab is active. Under 'Network Utilities', there is a 'Host' input field and an 'Action' section with three buttons: 'Ping', 'Traceroute', and 'Nslookup'.

	Field name	Explanation
1.	Host	Enter server IP address or hostname.

2.	Ping	Utility used to test the reach ability of a host on an Internet IP network and to measure the round-trip time for messages sent from the originating host to a destination server. Server echo response will be shown after few seconds if server is accessible.
3.	Traceroute	Diagnostics tool for displaying the route (path) and measuring transit delays of packets across an Internet IP network. Log containing route information will be shown after few seconds.
4.	Nslookup	Network administration command-line tool for querying the Domain Name System (DNS) to obtain domain name or IP address mapping or for any other specific DNS record. Log containing specified server DNS lookup information will be shown after few seconds.

10.3.5 MAC Clone

	Field name	Explanation
1.	WAN MAC address	Enter new WAN MAC address.

10.3.6 Overview

Select which information you want to get in Overview window (Status -> Overview).

	Field name	Explanation
1.	Mobile	Check box to show Mobile table in Overview page

2.	SMS counter	Check box to show SMS counter table in Overview page
3.	System	Check box to show System table in Overview page
4.	Wireless	Check box to show Wireless table in Overview page
5.	WAN	Check box to show WAN table in Overview page
6.	Local network	Check box to show Local network table in Overview page
7.	Access control	Check box to show Access control table in Overview page
8.	Recent system events	Check box to show Recent system events table in Overview page
9.	Recent network events	Check box to show Recent network events table in Overview page
10.	<Hotspot name> Hotspot	Check box to show Hotspot instance table in Overview page
11.	VRRP	Check box to show VRRP table in Overview page
12.	Monitoring	Check box to show Monitoring table in Overview page

10.3.7 Monitoring

Monitoring functionality allows your router to be connected to Remote Monitoring System. Also MAC address and router serial numbers are displayed for convenience in this page, because they are needed when adding device to monitoring system.

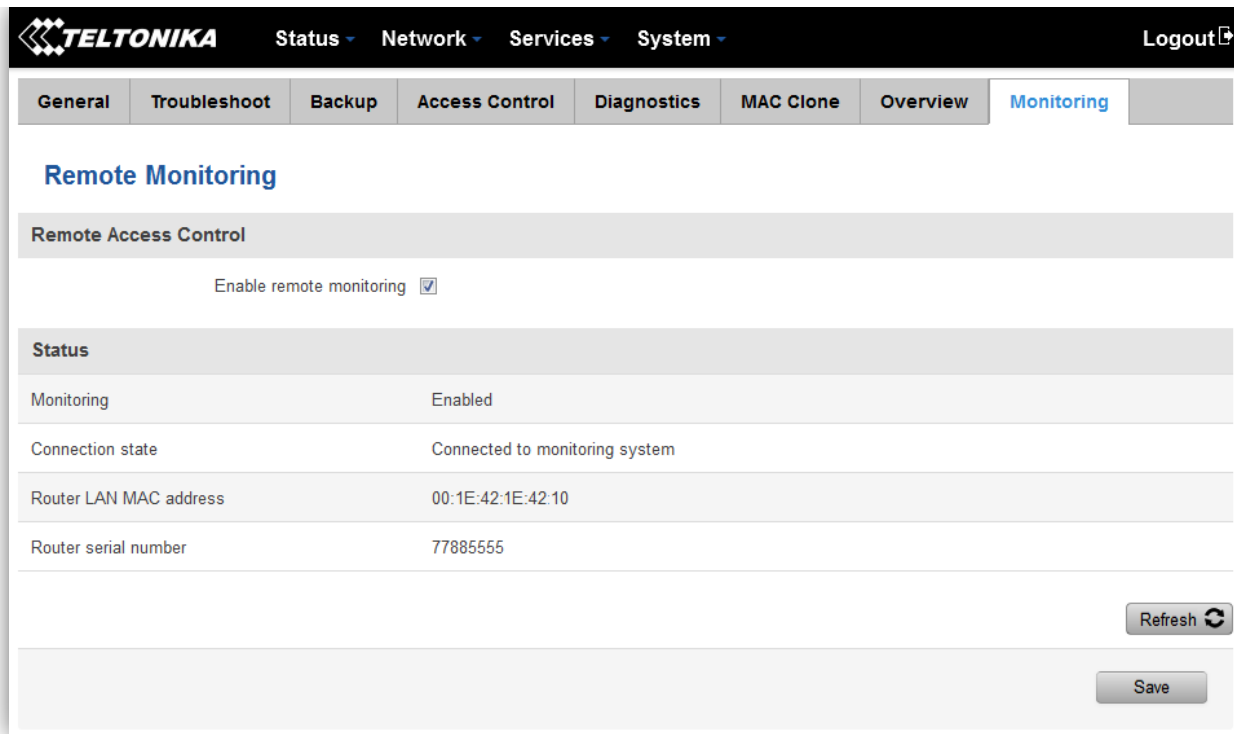

	Field name	Explanation
1.	Enable remote monitoring	Check box to enable/disable remote monitoring
2.	Monitoring	Shows monitoring status.
3.	Router LAN MAC address	MAC address of the Ethernet LAN ports
4.	Router serial number	Serial number of the device

10.4 User scripts

Advanced users can insert their own commands that will be executed at the end of booting process.

Startup Script Management

Insert your own commands to execute at the end of the boot process.

```
# Put your custom commands here that should be executed once
# the system init finished. By default this file does nothing.

exit 0
```

Upload script file No file selected.

Backup script file

In *Script Management* window is shown content of a file `/etc/rc.local`. This file is executed at the end of startup, executing the line: `sh /etc/rc.local` In this script is needed to use `sh` (ash) commands. It should be noted, that this is embedded device and `sh` functionality is not full.

10.5 Restore point

10.5.1 Restore point create

Allow to create firmware restore points with all custom configurations. You can download created restore points to your computer.

Create Restore Point

Create Restore Point And Download

Title

10.5.2 Restore point load

Allow to restore configuration from previously saved restore point. You can upload restore point from your computer.

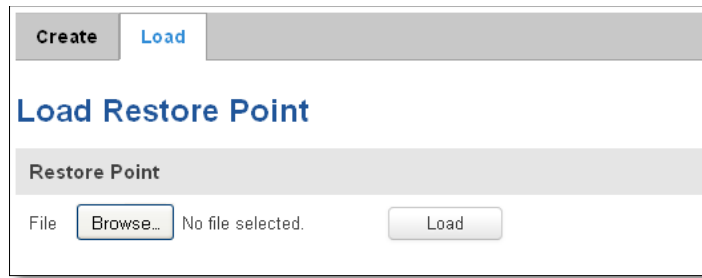

10.6 Firmware

10.6.1 Firmware

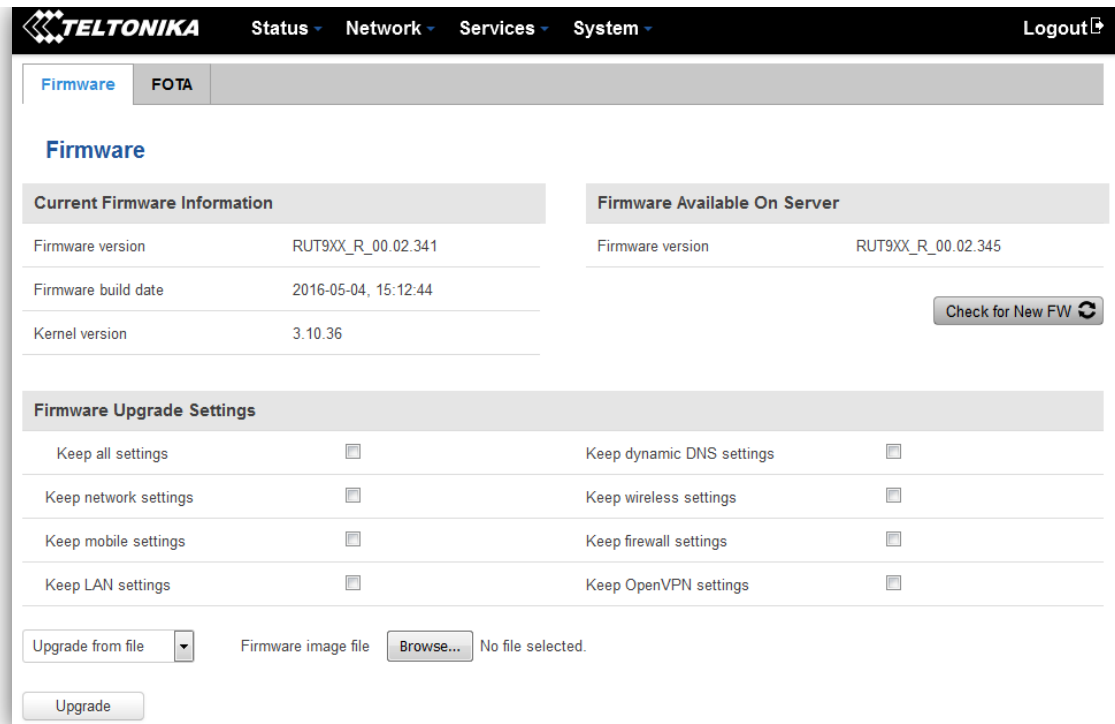

Keep all settings – if the check box is selected router will keep saved user configuration settings after firmware upgrade. When check box is not selected all router settings will be restored to factory defaults after firmware upgrade. When upgrading firmware, you can choose settings that you wish to keep after the upgrade. This function is useful when firmware is being upgraded via Internet (remotely) and you must not lose connection to the router afterwards.

FW image – router firmware upgrade file.

Warning: Never remove router power supply and do not press reset button during upgrade process! This would seriously damage your router and make it inaccessible. If you have any problems related to firmware upgrade you should always consult with local dealer.

10.6.2 FOTA

Firmware **FOTA**

Firmware Over The Air Configuration

Server Settings

Server address

User name

Password

Enable auto check

Auto check mode

WAN wired

	Field name	Explanation
1.	Server address	Specify server address to check for firmware updates. E.g. "http://teltonika.sritis.lt/rut9xx_auto_update/clients/"
2.	User name	User name for server authorization.
3.	Password	Password name for server authorization.
4.	Enable auto check	Check box to enable automatic checking for new firmware updates.
5.	Auto check mode	Select when to perform auto check function.
6.	WAN wired	Allows to update firmware from server only if routers WAN is wired (if box is checked).

10.7 Reboot

Router reboot

Warning! During reboot you will temporarily lose the connection.

Reboot router by pressing button "Reboot".

11 Device Recovery

The following section describes available options for recovery of malfunctioning device. Usually device can become unreachable due to power failure during firmware upgrade or if its core files were wrongly modified in the file system. Teltonika's routers offer several options for recovering from these situations.

11.1 Reset button

Reset button is located on the back panel of the device. Reset button has several functions:

Reboot the device. After the device has started and if the reset button is pressed for up to 4 seconds the device will reboot. Start of the reboot will be indicated by flashing of all 5 signal strength LEDs together with green connection status LED.

Reset to defaults. After the device has started if the reset button is pressed for at least 5 seconds the device will reset all user changes to factory defaults and reboot. To help user to determine how long the reset button should be pressed, signal strength LEDs indicates the elapsed time. All 5 lit LEDs means that 5 seconds have passed and reset button can be released. Start of the reset to defaults will be indicated by flashing of all 5 signal strength LEDs together with red connection status LED. SIM PIN on the main SIM card is the only user parameter that is kept after reset to defaults.

11.2 Bootloader's WebUI

Bootloader also provides a way to recover the router functionality when the firmware is damaged. To make it easier to use bootloader has its own webserver that can be accessed with any web browser.

Procedure for starting bootloader's webserver:

Automatically. It happens when bootloader does not detect master firmware. Flashing all 4 Ethernet LEDs indicate that bootloader's webserver has started.

Manually. Bootloader's webserver can be requested by holding reset button for 3 seconds while powering the device on. Flashing all 4 Ethernet LEDs indicates that bootloader's webserver has started.

Bootloader's WebUI can be accessed by typing this address in the web browser:

<http://192.168.1.1/index.html>

Note: it may be necessary to clear web browser's cache and to use incognito/anonymous window to access bootloader's WebUI.

12 Glossary:

WAN – Wide Area Network is a telecommunication network that covers a broad area (i.e., any network that links across metropolitan, regional, or national boundaries). Here we use the term WAN to mean the external network that the router uses to reach the internet.

LAN – A local area network (LAN) is a computer network that interconnects computers in a limited area such as a home, school, computer laboratory, or office building.

DHCP – The Dynamic Host Configuration Protocol (DHCP) is a network configuration protocol for hosts on Internet Protocol (IP) networks. Computers that are connected to IP networks must be configured before they can communicate with other hosts. The most essential information needed is an IP address, and a default route and routing prefix. DHCP eliminates the manual task by a network administrator. It also provides a central database of devices that are connected to the network and eliminates duplicate resource assignments.

ETHERNET CABLE – Refers to the CAT5 UTP cable with an RJ-45 connector.

AP – Access point. An access point is any device that provides wireless connectivity for wireless clients. In this case, when you enable Wi-Fi on your router, your router becomes an access point.

DNS – Domain Name Resolver. A server that translates names such as www.google.it to their respective IPs. In order for your computer or router to communicate with some external server it needs to know its IP, its name “www.something.com” just won’t do. There are special servers set in place that perform this specific task of resolving names into IPs, called Domain Name servers. If you have no DNS specified you can still browse the web, provided that you know the IP of the website you are trying to reach.

ARP – Short for Address Resolution Protocol, a network layer protocol used to convert an IP address into a physical address (called a *DLC address*), such as an Ethernet address.

PPPoE – Point-to-Point Protocol over Ethernet. PPPoE is a specification for connecting the users on an Ethernet to the internet through a common broadband medium, such as DSL line, wireless device or cable modem.

DSL – digital subscriber line - it is a family of technologies that provide internet access by transmitting digital data using a local telephone network which uses the public switched telephone network.

NAT – network address translation – an internet standard that enables a local-area network (LAN) to use one set of IP addresses for internet traffic and a second set of addresses for external traffic.

LCP – Link Control Protocol – a protocol that is part of the PPP (Point-to-Point Protocol). The LCP checks the identity of the linked device and either accepts or rejects the peer device, determines the acceptable packet size for transmission, searches for errors in configuration and can terminate the link if the parameters are not satisfied.

BOOTP – Bootstrap Protocol – an internet protocol that enables a diskless workstation to discover its own IP address, the IP address of a BOOTP server on the network, and a file to be loaded into memory to boot the machine. This enables the workstation to boot without requiring a hard or floppy disk drive.

TCP – Transmission Control Protocol – one of the main protocols in TCP/IP networks. Whereas the IP protocol deals only with packets, TCP enables two hosts to establish a connection and exchange streams of data. TCP guarantees delivery of data and also guarantees that packets will be delivered in the same order in which they were sent.

TKIP – Temporal Key Integrity Protocol – scrambles the keys using hashing algorithm and, by adding an integrity-checking feature, ensure that the keys haven’t been tampered with.

CCMP – Counter Mode Cipher Block Chaining Message Authentication Code Protocol – encryption protocol designed for Wireless LAN products that implement the standards of the IEEE 802.11i amendment to the original IEEE 802.11 standard. CCMP is an enhanced data cryptographic encapsulation designed for data confidentiality and based upon the Counter Mode with CBC-MAC (CCM) of the AES (Advanced Encryption Standard) standard.

MAC – Media Access Control – hardware address that uniquely identifies each node of a network. In IEEE 802 networks, the Data Link Control (DLC) layer of the ISO Reference Model is divided into two sub-layers: the Logical Link

Control (LLC) layer and the Media Access Control layer. The MAC layer interfaces directly with the network medium. Consequently, each different type of network medium requires a different MAC layer.

DMZ – Demilitarized Zone – a computer or small subnetwork that sits between a trusted internal network, such as a corporate private LAN, and an untrusted external network, such as the public internet.

UDP – User Datagram Protocol – a connectionless protocol that, like TCP, runs on top of IP networks. Provides very few error recovery services, offering instead a direct way to send and receive datagrams over IP network.

VPN – Virtual Private Network – a network that is constructed by using public wires — usually the Internet — to connect to a private network, such as a company's internal network.

VRRP – Virtual Router Redundancy Protocol - an election protocol that dynamically assigns responsibility for one or more virtual router(s) to the VRRP router(s) on a LAN, allowing several routers on a multiaccess link to utilize the same virtual IP address.

GRE Tunnel – Generic Routing Encapsulation - a tunneling protocol developed by Cisco Systems that can encapsulate a wide variety of network layer protocols inside virtual point-to-point links over an Internet Protocol internetwork.

PPPD – Point to Point Protocol Daemon – it is used to manage network connections between two nodes on Unix-like operating systems. It is configured using command-line arguments and configuration files.

SSH – Secure SHell - a program to log into another computer over a network, to execute commands in a remote machine, and to move files from one machine to another. It provides strong authentication and secure communications over insecure channels.

VRRPD – Virtual Router Redundancy Protocol – it is designed to eliminate the single point of failure associated with statically routed networks by automatically providing failover using multiple LAN paths through alternate routers.

SNMP – Simple Network Management Protocol - a set of protocols for managing complex networks. SNMP works by sending messages, called *protocol data units (PDUs)*, to different parts of a network.

